



ROHDE & SCHWARZ

Test and Measurement
Division

Operating Manual

VECTOR SIGNAL GENERATOR

SMIQ02B

1125.5555.02

SMIQ03B

1125.5555.03

SMIQ03HD

1125.5555.33

SMIQ04B

1125.5555.04

SMIQ06B

1125.5555.06

SMIQ06ATE

1125.5555.26

Volume 1

This Operating Manual consists of 2 volumes

Printed in the Federal
Republic of Germany

Supplement to Manual SMIQ06ATE

The functionality of model SMIQ06ATE and its compliance with specifications correspond to model SMIQ06B (see Data sheet SMIQB06B).

Model SMIQ06ATE differs from model SMIQ06B as follows:

- The instrument has no display (item 1 in front panel view)
- The connectors on the front panel (item 4 in front panel view) are provided on the rear panel.
- The following connectors are not fitted:
 - I Faded,
 - Q Faded,
 - I/Q AUX,
 - LF,
 - EXT 1,
 - EXT 2,
 - SYM CLK,
 - X-AXIS,
 - BLANK,
 - MARKER,
 - SER DATA,
 - PULS,
 - EXTTUNE
 - BER
 - DATA
 - BITCLOCK and
 - PAR DATA

For manual operation of the SMIQ06ATE please download SMIQ-TV from the www.rohde-schwarz.com website. SMIQ-TV runs on any external Windows™ PC including a GPIB controller and features a full display of the SMIQ.

Supplement to Manual SMIQ

Special Features of HD Model

VECTOR MOD menu with model SMIQ03HD:

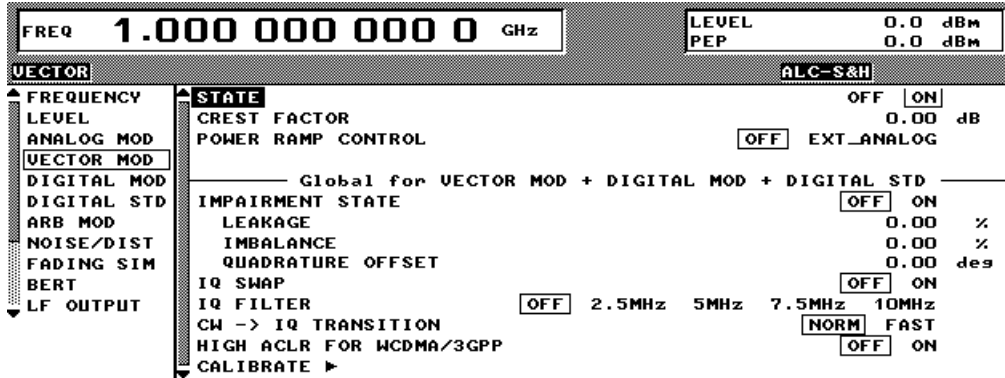

IQ FILTER Selection between filter off and a 2.5 MHz, 5 MHz, 7.5 MHz or 10 MHz lowpass filter in the baseband. The filters suppress noise in the baseband, which improves adjacent channel power (ACP) with W-CDMA. The filter frequency response is automatically compensated with DIGITAL MOD and DIGITAL STD in the MCODE mode, so that the error vector magnitude (EVM) deteriorates only slightly. If the VECTOR MOD mode is active and AMIQ with WinIQSIM used as a source, the frequency response is compensated by WinIQSIM. For applications requiring a very low EVM the I/Q filter should always be switched OFF.

- OFF filter off
- 2.5 MHz 2.5 MHz lowpass filter
- 5 MHz 5 MHz lowpass filter
- 7.5 MHz 7.5 MHz lowpass filter
- 10 MHz 10 MHz lowpass filter

IEC/IEEE-bus commands : SOUR:DM:IQ:FILT:STAT ON|OFF
 : SOUR:DM:IQ:FILT:FREQ 2.5MHz

HIGH ACLR W-CDMA signals with a very high adjacent channel power ratio (ACPR) can be generated in the 3GPP downlink band by means of option SMIQB57 (*High ACLR for W-CDMA*) in conjunction with option SMIQB20 (*Modulation Coder*). Moreover, RF peak levels up to +30 dBm can be produced thanks to the extremely linear power amplifier.

Note: Option SMIQB57 can be used only in the 2110 MHz to 2170 MHz 3GPP downlink band. Although carrier frequencies outside this band can be set, no specified values exist for such applications.

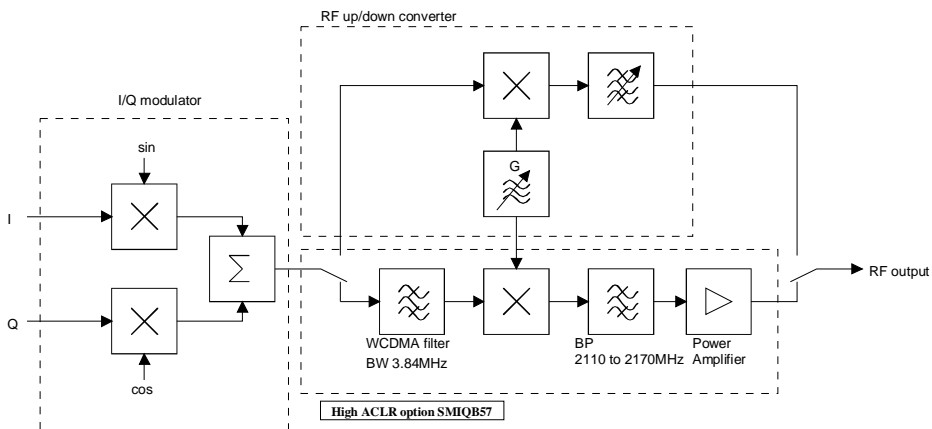

Fig. 1 High ACLR for W-CDMA

Option SMIQB57 incorporates a filter tailored to the channel bandwidth of a 3GPP W-CDMA signal (3.84 MHz) for suppressing unwanted signal components outside the useful band. SMIQB57 can for this reason be used effectively only with this particular type of digital modulation. Despite this, the option can be used with other digital modulation modes provided the occupied bandwidth is smaller than 3.84 MHz and the channel frequency is in the range of 2110 MHz to 2170 MHz. This may be expedient for applications requiring very high RF levels.

Output power with option SMIQB57 (*High ACLR for W-CDMA*):

With option SMIQB57 installed, the maximum output power is +30 dBm. The dynamic range of the electronic level setting is extended to 30 dB in the *Attenuator Fixed* mode.

IEC/IEEE-bus command : SOUR:DM:IQ:HACLR:STAT

New Features Not Concerning HD Model

VECTOR MOD menu

IQ FILTER Only with option SMIQB47; not on SMIQ03HD.

Selection between filter off and a 850 kHz, 2.5 MHz or 5 MHz lowpass filter in the baseband. The filters suppress noise in the baseband from 900 kHz, 3 MHz or 6 MHz, which improves adjacent channel power (ACP) with IS-95 and W-CDMA. The filter frequency response is automatically compensated with DIGITAL MOD and DIGITAL STD in the MCODE mode, so that the error vector magnitude (EVM) deteriorates only slightly. If the VECTOR MOD mode is active and AMIQ with WinIQSIM used as a source, the frequency response is compensated by WinIQSIM. For applications requiring a very low EVM the I/Q filter should always be switched OFF.

OFF	filter off
850 kHz	850 kHz lowpass filter
2.5 MHz	2.5 MHz lowpass filter
5 MHz	5 MHz lowpass filter

IEC/IEEE-bus commands : SOUR:DM:IQ:FILT:STAT ON|OFF
 : SOUR:DM:IQ:FILT:FREQ 2.5MHZ

New Features on All Models

DIGITAL MOD – FILTER menu:

A new filter was added:

(FILTER...)	FILTER TYPE	GAUSS LINEAR	linearized Gaussian filter for GSM_EDGE (to GSM Specification 05.04, Change Request A010) IEC/IEEE-bus command: :SOUR:DM:FILT:TYPE LGA
		GAUSS LINEAR (old version)	linearized Gaussian filter for GSM_EDGE (to GSM Specification older than 05.04) IEC/IEEE-bus command: :SOUR:DM:FILT:TYPE OLG

DIGITAL STD – WCDMA/3GPP menu:

OCNS CHANNELS was changed to ADD OCNS.

ADD OCNS Simulation of orthogonal channel noise. This menu item is available only in the downlink and if option SMIQB48 is installed. For more information refer to section 2.15.4.

Section 2.15.4 ADD OCNS:

Generation of orthogonal channel noise (OCNS) to TS 25.101

The OCNS scenario is defined as follows:

Table C.6: DPCH spreading code, timing offsets and relative level settings for OCNS signal

Channelization code	Timing offset ($\times 256T_{\text{chip}}$)	Level setting (dB)
2	86	-1
11	134	-3
17	52	-3
23	45	-5
31	143	-2
38	112	-4
47	59	-8
55	23	-7
62	1	-4
69	88	-6
78	30	-5
85	18	-9
94	30	-10
125	61	-8
113	128	-6
119	143	0

Parameters common to all OCNS channels:

Type: DPCH
Symbol rate: 30 ksp/s
Pilot length: 8 bit

The powers of the OCNS channels are to be understood as relative powers only. In the test scenarios defined by the standard, the OCNS channels are weighted so that a sum power of linear 1 (or 0 dB) is obtained. This is done automatically in SMIQ.

If ADD OCNS is set to ON,

- channels 15 to 30 of base station 1 are automatically set as shown in the table above and
- the power of the OCNS component is adjusted automatically so that the powers of the OCNS channels and the powers of the non-OCNS channels of base station 1 add up to yield a sum power of linear 1.

The settings for the 16 OCNS channels are READ ONLY settings, i.e. they cannot be modified. In the channel table, the OCNS channels are marked by an "O" after the channel number.

If the setting of a non-OCNS channel is modified, the power of the OCNS channels is adjusted immediately. If adjustment is not possible because the powers of the non-OCNS channels already add up to 0 dB or higher, the OCNS channels are set to -60 dB. In this case an error message is output when WCDMA/3GPP is switched on.

Further Settings of ENHANCED CHANNELS Menu:

SEQUENCE LENGTH The maximum sequence length not only depends on free DGEN list memory space but also decisively on the ENHANCED P-CCPCH/BCH status and, where applicable, on the number of DPCHs:

ENHANCED P-CCPCH/BCH STATE = OFF

1 DPCH:	1022 frames
2 DPCHs:	511 frames
3 DPCHs:	341 frames
4 DPCHs:	255 frames

ENHANCED P-CCPCH/BCH STATE = ON

SYMBOL RATE DPCH ≤ 30 ksp/s:	2044 frames
SYMBOL RATE DPCH > 30 ksp/s:	500 frames

New IEC/IEEE-Bus Commands

[:SOURce]:DM:IQ:FILTer:FREQuency 850 kHz, 2.5 MHz, 5 MHz, 7.5 MHz, 10 MHz

With this command, an IQ filter with the required cutoff frequency is selected. The command is available, with option SMIQB47 (*LOW ACP for IS-95 CDMA and W-CDMA*) installed, for cutoff frequencies 850 kHz, 2.5 MHz and 5 MHz. With model SMIQ03HD, cutoff frequencies 2.5 MHz, 5 MHz, 7.5 MHz and 10 MHz are available.

Example: `:SOUR:DM:IQ:FILT:FREQ 2.5MHZ`

*RST value is 2.5 MHz

[:SOURce]:DM:IQ:HACLR:STATe ON | OFF

This command switches the option SMIQB57 on or off.

Example: `:SOUR:DM:IQ:HACL:STAT ON`

*RST value is OFF

Supplement to Manual SMIQ Output Mode

FREQ 100.000 000 0 MHz		LEVEL -30.0 dBm PEP -27.3 dBm	
PHS PRAMP		ALC-S&H	
▲ FREQUENCY LEVEL ANALOG MOD VECTOR MOD DIGITAL MOD DIGITAL STD ARB MOD NOISE/DIST FADING SIM BERT LF OUTPUT ▼	LEVEL ALC UCOR EMF	AMPLITUDE OUTPUT MODE OFFSET LIMIT ATTENUATOR MODE ATTEN FIXED RANGE KNOB STEP USER KNOB STEP POWER RESOLUTION POWER-ON STATE EXCLUDE FROM RCL	-30.0 dBm NORMAL LOW_NOISE LOW_DIST 0.0 dB +25.0 dBm AUTO FIXED ELECTRONIC -52.7 dBm TO -29.7 dBm 1.0 dB DECIMAL USER 0.1 0.01 dB RF-OFF PREVIOUS-SETTING OFF ON

- NORMAL** This mode corresponds to that of the previous SMIQ.
- LOW NOISE:** The modulation in the SMIQ is set so that the power of the second and following adjacent channels (ALT1...) is minimal.
- LOW DIST:** The modulation in the SMIQ is set so that the power of the first adjacent channel (ADJ) is minimal. This optimization takes into consideration the modulation signal and the version-dependent parameters of the module at 2 GHz.

Hints for the individual modes:

- CW:** The output mode has no effect in this mode.
- VECTOR MOD:** With the LOW NOISE output mode, you should additionally raise the IQ level applied (max. 1 V p). The optimal IQ level with LOW DIST depends on the modulation signal and must be ascertained through measurements. The adjacent channel power for symbol rates <200 kHz is essentially determined through multiplicative phase noise. The IQ level can be set to 250 mV p independent of the modulation signal.
The level error caused by a change in the IQ level can be corrected with the LEVEL OFFSET.
- ARB MOD:** With the LOW NOISE / LOW DIST output mode, the modulation in the SMIQ only changes by a fixed amount. The user can vary the IQ level in order to achieve the best results with LOW DIST as a function of the modulation signal.
- FADSIM/NDSIM:** If these modules are activated, the output mode has no effect. If FSIM is activated, the adjacent channel power can be optimized by the parameter "Insertion Loss Setting Mode" in the FADSIM menu.

Additional hints:

The specifications for the level accuracy and harmonic ratio are only valid for the NORMAL output mode; in the other modes they can change.

```
IEC/IEEE-bus command: SOURce:POWer[:LEVel]:OMODE NORMAL
                        |LDIStortion
                        |LNOise
```

Tabbed Divider Overview

Volume 1

**How to Use this Manual
Contents**

**Data Sheet
Supplement to Data Sheet**

**Safety Instructions
Certificate of quality
EC Certificate of Conformity
List of R & S Representatives**

Tabbed Divider

1	Chapter 1:	Preparation for Use
2	Chapter 2:	Manual Operation
10	Index	

Volume 2

**How to Use this Manual
Contents
Safety Instructions**

Tabbed Divider

3	Chapter 3:	Remote Control
4	Chapter 4:	Maintenance
5	Chapter 5:	Performance Test
6	Annex A:	Interfaces
7	Annex B:	List of Error Messages
8	Annex C:	List of Commands
9	Annex D:	Programming Example
10	Index	

Introduction on how to use the manual

This operating manual contains essential information on commissioning, manual control, remote control, maintenance and checking the rated specifications of SMIQ as well as all specifications of the unit and available options.

The following models and options are described in this manual:

- SMIQ02B – Vector Signal Generator 300 kHz to 2.2 GHz
- SMIQ03B – Vector Signal Generator 300 kHz to 3.3 GHz
- SMIQ04B – Vector Signal Generator 300 kHz to 4.4 GHz
- SMIQ06B – Vector Signal Generator 300 kHz to 6.4 GHz

- Option SM-B1 – Reference Oscillator OCXO
- Option SM-B5 – FM/PM Modulator
- Option SMIQB11 – Data Generator
- Option SMIQB12 – Memory Extension to Data Generator
- Option SMIQB14 – Fading Simulator FSIM1
- Option SMIQB15 – Second Fading Simulator FSIM2
- Option SMIQB17 – Noise Generator and Distortion Simulator
- Option SMIQB19 – Rear Panel Connections for RF and LF
- Option SMIQB20 – Modulation Coder
- Option SMIQB21 – Bit Error Rate Test
- Option SMIQB42 – Digital Standard IS-95 CDMA
- Option SMIQB43 – Digital Standard W-CDMA
- Option SMIQB45 – Digital Standard 3 GPP W-CDMA
- Option SMIQB47 – LOW ACP Filter
- Option SMIQB48 – Enhanced Functions für 3GPP W-CDMA
- Option SMIQB49 – Dynamic Fading
- Option SMIQB60 – Arbitrary Waveform Generator

The chapters with associated contents are as follows:

Data sheets	list guaranteed specifications for the functions and characteristics of the unit and its options.
Chapter 1	provides information on putting the unit into operation (AC supply connection, switch-on/off), functional test, preset settings, fitting the options and mounting the unit into a 19" rack.
Chapter 2	explains the manual control of SMIQ. It contains front and rear panel views, describes the control elements as well as connectors, provides a short introduction with sample settings for first-time users. It also explains how to change parameters and the use of the list editor and gives an overview of the menus for the functions covered by the unit and its options. It also presents the functions and menus of the unit and its options (frequency and level setting, analog and digital modulation, ARB, external modulation source AMIQ, fading simulation, noise generation and distortion simulation, BERT, sweep, LIST mode, memory sequence and general functions not relating to signal generation).

Chapter 3	provides information on remote control of SMIQ. It informs about basics like IEC/IEEE bus, RS-232C interface, interface and device-dependent messages, command processing, status reporting system etc. It also includes an overview of each command system and describes all commands available in the unit and its options.
Chapter 4	informs about preventive maintenance and functional tests.
Chapter 5	contains information on how to check the rated specifications (required test equipment, test setup, test procedure) and on the performance test report.
Annex A	provides information on interfaces.
Annex B	contains a list of SCPI- and SMIQ-specific error messages displayed by the unit.
Annex C	provides an alphabetical list of commands.
Annex D	gives programming examples for remote control.
Index	provides the index with entries in alphabetical order.



Before putting the product into operation for the first time, make sure to read the following



S a f e t y I n s t r u c t i o n s

Rohde & Schwarz makes every effort to keep the safety standard of its products up to date and to offer its customers the highest possible degree of safety. Our products and the auxiliary equipment required for them are designed and tested in accordance with the relevant safety standards. Compliance with these standards is continuously monitored by our quality assurance system. This product has been designed and tested in accordance with the EC Certificate of Conformity and has left the manufacturer's plant in a condition fully complying with safety standards. To maintain this condition and to ensure safe operation, observe all instructions and warnings provided in this manual. If you have any questions regarding these safety instructions, Rohde & Schwarz will be happy to answer them.

Furthermore, it is your responsibility to use the product in an appropriate manner. This product is designed for use solely in industrial and laboratory environments or in the field and must not be used in any way that may cause personal injury or property damage. You are responsible if the product is used for an intention other than its designated purpose or in disregard of the manufacturer's instructions. The manufacturer shall assume no responsibility for such use of the product.

The product is used for its designated purpose if it is used in accordance with its operating manual and within its performance limits (see data sheet, documentation, the following safety instructions). Using the products requires technical skills and knowledge of English. It is therefore essential that the products be used exclusively by skilled and specialized staff or thoroughly trained personnel with the required skills. If personal safety gear is required for using Rohde & Schwarz products, this will be indicated at the appropriate place in the product documentation.

Symbols and safety labels

Observe operating instructions	Weight indication for units >18 kg	Danger of electric shock	Warning! Hot surface	PE terminal	Ground	Ground terminal	Attention! Electrostatic sensitive devices

Supply voltage ON/OFF	Standby indication	Direct current (DC)	Alternating current (AC)	Direct/alternating current (DC/AC)	Device fully protected by double/reinforced insulation

Safety Instructions

Observing the safety instructions will help prevent personal injury or damage of any kind caused by dangerous situations. Therefore, carefully read through and adhere to the following safety instructions before putting the product into operation. It is also absolutely essential to observe the additional safety instructions on personal safety that appear in other parts of the documentation. In these safety instructions, the word "product" refers to all merchandise sold and distributed by Rohde & Schwarz, including instruments, systems and all accessories.

Tags and their meaning

DANGER	This tag indicates a safety hazard with a high potential of risk for the user that can result in death or serious injuries.
WARNING	This tag indicates a safety hazard with a medium potential of risk for the user that can result in death or serious injuries.
CAUTION	This tag indicates a safety hazard with a low potential of risk for the user that can result in slight or minor injuries.
ATTENTION	This tag indicates the possibility of incorrect use that can cause damage to the product.
NOTE	This tag indicates a situation where the user should pay special attention to operating the product but which does not lead to damage.

These tags are in accordance with the standard definition for civil applications in the European Economic Area. Definitions that deviate from the standard definition may also exist. It is therefore essential to make sure that the tags described here are always used only in connection with the associated documentation and the associated product. The use of tags in connection with unassociated products or unassociated documentation can result in misinterpretations and thus contribute to personal injury or material damage.

Basic safety instructions

1. The product may be operated only under the operating conditions and in the positions specified by the manufacturer. Its ventilation must not be obstructed during operation. Unless otherwise specified, the following requirements apply to Rohde & Schwarz products:
prescribed operating position is always with the housing floor facing down, IP protection 2X, pollution severity 2, overvoltage category 2, use only in enclosed spaces, max. operation altitude max. 2000 m. Unless specified otherwise in the data sheet, a tolerance of $\pm 10\%$ shall apply to the nominal voltage and of $\pm 5\%$ to the nominal frequency.
2. Applicable local or national safety regulations and rules for the prevention of accidents must be observed in all work performed. The product may be opened only by authorized, specially trained personnel. Prior to performing any work on the product or opening the product, the product must be disconnected from the supply network. Any adjustments, replacements of parts, maintenance or repair must be carried out only by technical personnel authorized by Rohde & Schwarz. Only original parts may be used for replacing parts relevant to safety (e.g. power switches, power transformers, fuses). A safety test must always be performed after parts relevant to safety have been replaced (visual inspection, PE conductor test, insulation resistance measurement, leakage current measurement, functional test).
3. As with all industrially manufactured goods, the use of substances that induce an allergic reaction (allergens, e.g. nickel) such as aluminum cannot be generally excluded. If you develop an allergic reaction (such as a skin rash, frequent sneezing, red eyes or respiratory difficulties), consult a physician immediately to determine the cause.

Safety Instructions

4. If products/components are mechanically and/or thermally processed in a manner that goes beyond their intended use, hazardous substances (heavy-metal dust such as lead, beryllium, nickel) may be released. For this reason, the product may only be disassembled, e.g. for disposal purposes, by specially trained personnel. Improper disassembly may be hazardous to your health. National waste disposal regulations must be observed.
5. If handling the product yields hazardous substances or fuels that must be disposed of in a special way, e.g. coolants or engine oils that must be replenished regularly, the safety instructions of the manufacturer of the hazardous substances or fuels and the applicable regional waste disposal regulations must be observed. Also observe the relevant safety instructions in the product documentation.
6. Depending on the function, certain products such as RF radio equipment can produce an elevated level of electromagnetic radiation. Considering that unborn life requires increased protection, pregnant women should be protected by appropriate measures. Persons with pacemakers may also be endangered by electromagnetic radiation. The employer is required to assess workplaces where there is a special risk of exposure to radiation and, if necessary, take measures to avert the danger.
7. Operating the products requires special training and intense concentration. Make certain that persons who use the products are physically, mentally and emotionally fit enough to handle operating the products; otherwise injuries or material damage may occur. It is the responsibility of the employer to select suitable personnel for operating the products.
8. Prior to switching on the product, it must be ensured that the nominal voltage setting on the product matches the nominal voltage of the AC supply network. If a different voltage is to be set, the power fuse of the product may have to be changed accordingly.
9. In the case of products of safety class I with movable power cord and connector, operation is permitted only on sockets with earthing contact and protective earth connection.
10. Intentionally breaking the protective earth connection either in the feed line or in the product itself is not permitted. Doing so can result in the danger of an electric shock from the product. If extension cords or connector strips are implemented, they must be checked on a regular basis to ensure that they are safe to use.
11. If the product has no power switch for disconnection from the AC supply, the plug of the connecting cable is regarded as the disconnecting device. In such cases, it must be ensured that the power plug is easily reachable and accessible at all times (length of connecting cable approx. 2 m). Functional or electronic switches are not suitable for providing disconnection from the AC supply. If products without power switches are integrated in racks or systems, a disconnecting device must be provided at the system level.
12. Never use the product if the power cable is damaged. By taking appropriate safety measures and carefully laying the power cable, ensure that the cable cannot be damaged and that no one can be hurt by e.g. tripping over the cable or suffering an electric shock.
13. The product may be operated only from TN/TT supply networks fused with max. 16 A.
14. Do not insert the plug into sockets that are dusty or dirty. Insert the plug firmly and all the way into the socket. Otherwise this can result in sparks, fire and/or injuries.
15. Do not overload any sockets, extension cords or connector strips; doing so can cause fire or electric shocks.
16. For measurements in circuits with voltages $V_{\text{rms}} > 30 \text{ V}$, suitable measures (e.g. appropriate measuring equipment, fusing, current limiting, electrical separation, insulation) should be taken to avoid any hazards.
17. Ensure that the connections with information technology equipment comply with IEC 950/EN 60950.
18. Never remove the cover or part of the housing while you are operating the product. This will expose circuits and components and can lead to injuries, fire or damage to the product.

Safety Instructions

19. If a product is to be permanently installed, the connection between the PE terminal on site and the product's PE conductor must be made first before any other connection is made. The product may be installed and connected only by a skilled electrician.
20. For permanently installed equipment without built-in fuses, circuit breakers or similar protective devices, the supply circuit must be fused in such a way that suitable protection is provided for users and products.
21. Do not insert any objects into the openings in the housing that are not designed for this purpose. Never pour any liquids onto or into the housing. This can cause short circuits inside the product and/or electric shocks, fire or injuries.
22. Use suitable overvoltage protection to ensure that no overvoltage (such as that caused by a thunderstorm) can reach the product. Otherwise the operating personnel will be endangered by electric shocks.
23. Rohde & Schwarz products are not protected against penetration of water, unless otherwise specified (see also safety instruction 1.). If this is not taken into account, there exists the danger of electric shock or damage to the product, which can also lead to personal injury.
24. Never use the product under conditions in which condensation has formed or can form in or on the product, e.g. if the product was moved from a cold to a warm environment.
25. Do not close any slots or openings on the product, since they are necessary for ventilation and prevent the product from overheating. Do not place the product on soft surfaces such as sofas or rugs or inside a closed housing, unless this is well ventilated.
26. Do not place the product on heat-generating devices such as radiators or fan heaters. The temperature of the environment must not exceed the maximum temperature specified in the data sheet.
27. Batteries and storage batteries must not be exposed to high temperatures or fire. Keep batteries and storage batteries away from children. If batteries or storage batteries are improperly replaced, this can cause an explosion (warning: lithium cells). Replace the battery or storage battery only with the matching Rohde & Schwarz type (see spare parts list). Batteries and storage batteries are hazardous waste. Dispose of them only in specially marked containers. Observe local regulations regarding waste disposal. Do not short-circuit batteries or storage batteries.
28. Please be aware that in the event of a fire, toxic substances (gases, liquids etc.) that may be hazardous to your health may escape from the product.
29. Please be aware of the weight of the product. Be careful when moving it; otherwise you may injure your back or other parts of your body.
30. Do not place the product on surfaces, vehicles, cabinets or tables that for reasons of weight or stability are unsuitable for this purpose. Always follow the manufacturer's installation instructions when installing the product and fastening it to objects or structures (e.g. walls and shelves).
31. Handles on the products are designed exclusively for personnel to hold or carry the product. It is therefore not permissible to use handles for fastening the product to or on means of transport such as cranes, fork lifts, wagons, etc. The user is responsible for securely fastening the products to or on the means of transport and for observing the safety regulations of the manufacturer of the means of transport. Noncompliance can result in personal injury or material damage.
32. If you use the product in a vehicle, it is the sole responsibility of the driver to drive the vehicle safely. Adequately secure the product in the vehicle to prevent injuries or other damage in the event of an accident. Never use the product in a moving vehicle if doing so could distract the driver of the vehicle. The driver is always responsible for the safety of the vehicle; the manufacturer assumes no responsibility for accidents or collisions.
33. If a laser product (e.g. a CD/DVD drive) is integrated in a Rohde & Schwarz product, do not use any other settings or functions than those described in the documentation. Otherwise this may be hazardous to your health, since the laser beam can cause irreversible damage to your eyes. Never try to take such products apart, and never look into the laser beam.



Por favor lea imprescindiblemente antes de la primera puesta en funcionamiento las siguientes informaciones de seguridad



Informaciones de seguridad

Es el principio de Rohde & Schwarz de tener a sus productos siempre al día con los standards de seguridad y de ofrecer a sus clientes el máximo grado de seguridad. Nuestros productos y todos los equipos adicionales son siempre fabricados y examinados según las normas de seguridad vigentes. Nuestra sección de gestión de la seguridad de calidad controla constantemente que sean cumplidas estas normas. Este producto ha sido fabricado y examinado según el comprobante de conformidad adjunto según las normas de la CE y ha salido de nuestra planta en estado impecable según los standards técnicos de seguridad. Para poder preservar este estado y garantizar un funcionamiento libre de peligros, deberá el usuario atenerse a todas las informaciones, informaciones de seguridad y notas de alerta. Rohde&Schwarz está siempre a su disposición en caso de que tengan preguntas referentes a estas informaciones de seguridad.

Además queda en la responsabilidad del usuario utilizar el producto en la forma debida. Este producto solamente fue elaborado para ser utilizado en la industria y el laboratorio o para fines de campo y de ninguna manera deberá ser utilizado de modo que alguna persona/cosa pueda ser dañada. El uso del producto fuera de sus fines definidos o despreciando las informaciones de seguridad del fabricante queda en la responsabilidad del usuario. El fabricante no se hace en ninguna forma responsable de consecuencias a causa del maluso del producto.

Se parte del uso correcto del producto para los fines definidos si el producto es utilizado dentro de las instrucciones del correspondiente manual del uso y dentro del margen de rendimiento definido (ver hoja de datos, documentación, informaciones de seguridad que siguen). El uso de los productos hace necesarios conocimientos profundos y el conocimiento del idioma inglés. Por eso se deberá tener en cuenta de exclusivamente autorizar para el uso de los productos a personas péritas o debidamente minuciosamente instruidas con los conocimientos citados. Si fuera necesaria indumentaria de seguridad para el uso de productos de R&S, encontrará la información debida en la documentación del producto en el capítulo correspondiente.

Símbolos y definiciones de seguridad

Ver manual de instrucciones del uso	Informaciones para maquinaria con un peso de > 18kg	Peligro de golpe de corriente	¡Advertencia! Superficie caliente	Conexión a conductor protector	Conexión a tierra	Conexión a masa conductora	¡Cuidado! Elementos de construcción con peligro de carga electrostática

potencia EN MARCHA/PARADA	Indicación Stand-by	Corriente continua DC	Corriente alterna AC	Corriente continua/alterna DC/AC	El aparato está protegido en su totalidad por un aislamiento de doble refuerzo

Informaciones de seguridad

Tener en cuenta las informaciones de seguridad sirve para tratar de evitar daños y peligros de toda clase. Es necesario de que se lean las siguientes informaciones de seguridad concienzudamente y se tengan en cuenta debidamente antes de la puesta en funcionamiento del producto. También deberán ser tenidas en cuenta las informaciones para la protección de personas que encontrarán en otro capítulo de esta documentación y que también son obligatorias de seguir. En las informaciones de seguridad actuales hemos juntado todos los objetos vendidos por Rohde&Schwarz bajo la denominación de „producto“, entre ellos también aparatos, instalaciones así como toda clase de accesorios.

Palabras de señal y su significado

PELIGRO	Indica un punto de peligro con gran potencial de riesgo para el usuario. Punto de peligro que puede llevar hasta la muerte o graves heridas.
ADVERTENCIA	Indica un punto de peligro con un potencial de riesgo mediano para el usuario. Punto de peligro que puede llevar hasta la muerte o graves heridas .
ATENCIÓN	Indica un punto de peligro con un potencial de riesgo pequeño para el usuario. Punto de peligro que puede llevar hasta heridas leves o pequeñas
CUIDADO	Indica la posibilidad de utilizar mal el producto y a consecuencia dañarlo.
INFORMACIÓN	Indica una situación en la que deberían seguirse las instrucciones en el uso del producto, pero que no consecuentemente deben de llevar a un daño del mismo.

Las palabras de señal corresponden a la definición habitual para aplicaciones civiles en el ámbito de la comunidad económica europea. Pueden existir definiciones diferentes a esta definición. Por eso se debiera tener en cuenta que las palabras de señal aquí descritas sean utilizadas siempre solamente en combinación con la correspondiente documentación y solamente en combinación con el producto correspondiente. La utilización de las palabras de señal en combinación con productos o documentaciones que no les correspondan puede llevar a malinterpretaciones y tener por consecuencia daños en personas u objetos.

Informaciones de seguridad elementales

1. El producto solamente debe ser utilizado según lo indicado por el fabricante referente a la situación y posición de funcionamiento sin que se obstruya la ventilación. Si no se convino de otra manera, es para los productos R&S válido lo que sigue: como posición de funcionamiento se define principalmente la posición con el suelo de la caja para abajo , modo de protección IP 2X, grado de suciedad 2, categoría de sobrecarga eléctrica 2, utilizar solamente en estancias interiores, utilización hasta 2000 m sobre el nivel del mar.
A menos que se especifique otra cosa en la hoja de datos, se aplicará una tolerancia de $\pm 10\%$ sobre el voltaje nominal y de $\pm 5\%$ sobre la frecuencia nominal.
2. En todos los trabajos deberán ser tenidas en cuenta las normas locales de seguridad de trabajo y de prevención de accidentes. El producto solamente debe de ser abierto por personal périto autorizado. Antes de efectuar trabajos en el producto o abrirlo deberá este ser desconectado de la corriente. El ajuste, el cambio de partes, la manutención y la reparación deberán ser solamente efectuadas por electricistas autorizados por R&S. Si se reponen partes con importancia para los aspectos de seguridad (por ejemplo el enchufe, los transformadores o los fusibles), solamente podrán ser sustituidos por partes originales. Despues de cada recambio de partes elementales para la seguridad deberá ser efectuado un control de

Informaciones de seguridad

- seguridad (control a primera vista, control de conductor protector, medición de resistencia de aislamiento, medición de medición de la corriente conductora, control de funcionamiento).
3. Como en todo producto de fabricación industrial no puede ser excluido en general de que se produzcan al usarlo elementos que puedan generar alergias, los llamados elementos alergénicos (por ejemplo el níquel). Si se produjeran en el trato con productos R&S reacciones alérgicas, como por ejemplo urticaria, estornudos frecuentes, irritación de la conjuntiva o dificultades al respirar, se deberá consultar inmediatamente a un médico para averiguar los motivos de estas reacciones.
 4. Si productos / elementos de construcción son tratados fuera del funcionamiento definido de forma mecánica o térmica, pueden generarse elementos peligrosos (polvos de sustancia de metales pesados como por ejemplo plomo, berilio, níquel). La partición elemental del producto, como por ejemplo sucede en el tratamiento de materias residuales, debe de ser efectuada solamente por personal especializado para estos tratamientos. La partición elemental efectuada inadecuadamente puede generar daños para la salud. Se deben tener en cuenta las directivas nacionales referentes al tratamiento de materias residuales.
 5. En el caso de que se produjeran agentes de peligro o combustibles en la aplicación del producto que debieran de ser transferidos a un tratamiento de materias residuales, como por ejemplo agentes refrigerantes que deben ser repuestos en periodos definidos, o aceites para motores, deberán ser tenidas en cuenta las prescripciones de seguridad del fabricante de estos agentes de peligro o combustibles y las regulaciones regionales para el tratamiento de materias residuales. Cuiden también de tener en cuenta en caso dado las prescripciones de seguridad especiales en la descripción del producto.
 6. Ciertos productos, como por ejemplo las instalaciones de radiación HF, pueden a causa de su función natural, emitir una radiación electromagnética aumentada. En vista a la protección de la vida en desarrollo deberían ser protegidas personas embarazadas debidamente. También las personas con un bypass pueden correr peligro a causa de la radiación electromagnética. El empresario está comprometido a valorar y señalar áreas de trabajo en las que se corra un riesgo de exposición a radiaciones aumentadas de riesgo aumentado para evitar riesgos.
 7. La utilización de los productos requiere instrucciones especiales y una alta concentración en el manejo. Debe de ponerse por seguro de que las personas que manejen los productos estén a la altura de los requerimientos necesarios referente a sus aptitudes físicas, psíquicas y emocionales, ya que de otra manera no se pueden excluir lesiones o daños de objetos. El empresario lleva la responsabilidad de seleccionar el personal usuario apto para el manejo de los productos.
 8. Antes de la puesta en marcha del producto se deberá tener por seguro de que la tensión preseleccionada en el producto equivalga a la de la red de distribución. Si es necesario cambiar la preselección de la tensión también se deberán en caso de cambio cambiar los fusibles correspondientes del producto.
 9. Productos de la clase de seguridad I con alimentación móvil y enchufe individual de producto solamente deberán ser conectados para el funcionamiento a tomas de corriente de contacto de seguridad y con conductor protector conectado.
 10. Queda prohibida toda clase de interrupción intencionada del conductor protector, tanto en la toma de corriente como en el mismo producto ya que puede tener como consecuencia el peligro de golpe de corriente por el producto. Si se utilizaran cables o enchufes de extensión se deberá poner al seguro, que es controlado su estado técnico de seguridad.
 11. Si el producto no está equipado con un interruptor para desconectarlo de la red, se deberá considerar el enchufe del cable de distribución como interruptor. En estos casos deberá asegurarse de que el enchufe sea de fácil acceso y nabejo (medida del cable de distribución aproximadamente 2 m). Los interruptores de función o electrónicos no son aptos para el corte de la red eléctrica. Si los productos sin interruptor están integrados en construcciones o instalaciones, se deberá instalar el interruptor al nivel de la instalación.

Informaciones de seguridad

12. No utilice nunca el producto si está dañado el cable eléctrico. Asegure a través de las medidas de protección y de instalación adecuadas de que el cable de eléctrico no pueda ser dañado o de que nadie pueda ser dañado por él, por ejemplo al tropezar o por un golpe de corriente.
13. Solamente está permitido el funcionamiento en redes de distribución TN/TT aseguradas con fusibles de como máximo 16 A.
14. Nunca conecte el enchufe en tomas de corriente sucias o llenas de polvo. Introduzca el enchufe por completo y fuertemente en la toma de corriente. Si no tiene en consideración estas indicaciones se arriesga a que se originen chispas, fuego y/o heridas.
15. No sobrecargue las tomas de corriente, los cables de extensión o los enchufes de extensión ya que esto pudiera causar fuego o golpes de corriente.
16. En las mediciones en circuitos de corriente con una tensión de entrada de $U_{eff} > 30 \text{ V}$ se deberá tomar las precauciones debidas para impedir cualquier peligro (por ejemplo medios de medición adecuados, seguros, limitación de tensión, corte protector, aislamiento etc.).
17. En caso de conexión con aparatos de la técnica informática se deberá tener en cuenta que estos cumplan los requisitos de la EC950/EN60950.
18. Nunca abra la tapa o parte de ella si el producto está en funcionamiento. Esto pone a descubierto los cables y componentes eléctricos y puede causar heridas, fuego o daños en el producto.
19. Si un producto es instalado fijamente en un lugar, se deberá primero conectar el conductor protector fijo con el conductor protector del aparato antes de hacer cualquier otra conexión. La instalación y la conexión deberán ser efectuadas por un electricista especializado.
20. En caso de que los productos que son instalados fijamente en un lugar sean sin protector implementado, autointerruptor o similares objetos de protección, deberá la toma de corriente estar protegida de manera que los productos o los usuarios estén suficientemente protegidos.
21. Por favor, no introduzca ningún objeto que no esté destinado a ello en los orificios de la caja del aparato. No vierta nunca ninguna clase de líquidos sobre o en la caja. Esto puede producir corto circuitos en el producto y/o puede causar golpes de corriente, fuego o heridas.
22. Asegúrese con la protección adecuada de que no pueda originarse en el producto una sobrecarga por ejemplo a causa de una tormenta. Si no se verá el personal que lo utilice expuesto al peligro de un golpe de corriente.
23. Los productos R&S no están protegidos contra el agua si no es que exista otra indicación, ver también punto 1. Si no se tiene en cuenta esto se arriesga el peligro de golpe de corriente o de daños en el producto lo cual también puede llevar al peligro de personas.
24. No utilice el producto bajo condiciones en las que pueda producirse y se hayan producido líquidos de condensación en o dentro del producto como por ejemplo cuando se desplaza el producto de un lugar frío a un lugar caliente.
25. Por favor no cierre ninguna ranura u orificio del producto, ya que estas son necesarias para la ventilación e impiden que el producto se caliente demasiado. No pongan el producto encima de materiales blandos como por ejemplo sofás o alfombras o dentro de una caja cerrada, si esta no está suficientemente ventilada.
26. No ponga el producto sobre aparatos que produzcan calor, como por ejemplo radiadores o calentadores. La temperatura ambiental no debe superar la temperatura máxima especificada en la hoja de datos.

Informaciones de seguridad

27. Baterías y acumuladores no deben de ser expuestos a temperaturas altas o al fuego. Guardar baterías y acumuladores fuera del alcance de los niños. Si las baterías o los acumuladores no son cambiados con la debida atención existirá peligro de explosión (atención celulas de Litio). Cambiar las baterías o los acumuladores solamente por los del tipo R&S correspondiente (ver lista de piezas de recambio). Baterías y acumuladores son deshechos problemáticos. Por favor tirenlos en los recipientes especiales para este fin. Por favor tengan en cuenta las prescripciones nacionales de cada país referente al tratamiento de deshechos. Nunca sometan las baterías o acumuladores a un corto circuito.
28. Tengan en consideración de que en caso de un incendio pueden escaparse gases tóxicos del producto, que pueden causar daños a la salud.
29. Por favor tengan en cuenta que en caso de un incendio pueden desprenderse del producto agentes venenosos (gases, líquidos etc.) que pueden generar daños a la salud.
30. No sitúe el producto encima de superficies, vehículos, estantes o mesas, que por sus características de peso o de estabilidad no sean aptas para él. Siga siempre las instrucciones de instalación del fabricante cuando instale y asegure el producto en objetos o estructuras (por ejemplo paredes y estantes).
31. Las asas instaladas en los productos sirven solamente de ayuda para el manejo que solamente está previsto para personas. Por eso no está permitido utilizar las asas para la sujecion en o sobre medios de transporte como por ejemplo grúas, carretillas elevadoras de horquilla, carros etc. El usuario es responsable de que los productos sean sujetados de forma segura a los medios de transporte y de que las prescripciones de seguridad del fabricante de los medios de transporte sean tenidas en cuenta. En caso de que no se tengan en cuenta pueden causarse daños en personas y objetos.
32. Si llega a utilizar el producto dentro de un vehículo, queda en la responsabilidad absoluta del conductor que conducir el vehículo de manera segura. Asegure el producto dentro del vehículo debidamente para evitar en caso de un accidente las lesiones u otra clase de daños. No utilice nunca el producto dentro de un vehículo en movimiento si esto pudiera distraer al conductor. Siempre queda en la responsabilidad absoluta del conductor la seguridad del vehículo y el fabricante no asumirá ninguna clase de responsabilidad por accidentes o colisiones.
33. Dado el caso de que esté integrado un producto de laser en un producto R&S (por ejemplo CD/DVD-ROM) no utilice otras instalaciones o funciones que las descritas en la documentación. De otra manera pondrá en peligro su salud, ya que el rayo laser puede dañar irreversiblemente sus ojos. Nunca trate de descomponer estos productos. Nunca mire dentro del rayo laser.

Contents

1	Preparation for Use	1.2
1.1	Putting into Operation.....	1.2
1.1.1	Supply Voltage	1.2
1.1.2	Switching On/Off the Instrument	1.2
1.1.3	Initial Status.....	1.3
1.1.4	Setting Contrast and Brightness of the Display.....	1.3
1.1.5	RAM with Battery Back-Up.....	1.3
1.1.6	Preset Setting.....	1.4
1.2	Functional Test	1.4
1.3	Fitting the Options.....	1.5
1.3.1	Opening the Casing.....	1.5
1.3.2	Overview of the Slots	1.6
1.3.3	Option SM-B1 - Reference Oscillator OCXO	1.6
1.3.4	Option SM-B5 - FM/PM Modulator	1.8
1.3.5	Option SMIQB11 - Data Generator	1.9
1.3.6	Option SMIQB12 - Memory Extension to Data Generator	1.9
1.3.7	Option SMIQB14 - Fading Simulator FSIM1	1.10
1.3.8	Option SMIQB15 - Second Fading Simulator (FSIM2)	1.12
1.3.9	Option SMIQB17 - Noise Generator and Distortion Simulator	1.14
1.3.10	Option SMIQB20 - Modulation Coder.....	1.15
1.3.11	Option SMIQB21 - Bit Error Rate Test	1.16
1.3.12	Other Software Options.....	1.17
1.3.13	Option SMIQB19 - Rear Panel Connections for RF and LF.....	1.18
1.4	Mounting into a 19" Rack	1.18

2	Operation	2.1
2.1	Front and Rear Panel	2.1
2.1.1	Display.....	2.1
2.1.2	Controls and Inputs/Outputs of the Front Panel.....	2.3
2.1.3	Elements of the Rear Panel	2.13
2.2	Basic Operating Steps	2.22
2.2.1	Design of the Display	2.22
2.2.2	Calling the Menus.....	2.23
2.2.3	Selection and Change of Parameters	2.24
2.2.4	Triggering Action	2.25
2.2.5	Quick Selection of Menu (QUICK SELECT)	2.25
2.2.6	Use of [FREQ] and [LEVEL] Keys.....	2.26
2.2.7	Use of [RF ON/OFF] and [MOD ON/OFF] Keys	2.26
2.2.8	[ENTER] Key – Special Toggle Function	2.26
2.2.9	Changing Unit of Level	2.26
2.2.10	Correction of Input.....	2.27
2.2.11	Sample Setting for First Users	2.27
2.2.12	List Editor	2.32
2.2.12.1	Select and Generate - SELECT LIST	2.33
2.2.12.2	Deletion of Lists - DELETE LIST	2.34
2.2.12.3	Edition of Lists.....	2.35
2.2.12.4	Pattern Setting to Operate the List Editor	2.39
2.2.12	Save/Recall - Storing/Calling of Instrument Settings	2.43
2.3	Menu Summary	2.44
2.4	RF Frequency.....	2.45
2.4.1	Frequency Offset.....	2.46
2.5	RF Level.....	2.47
2.5.1	Level Offset	2.49
2.5.2	Interrupt-free Level Setting.....	2.50
2.5.3	Switching On/Off Internal Level Control	2.50
2.5.4	User Correction (UCOR)	2.52
2.5.5	EMF	2.53
2.5.6	[RF ON / OFF]-Key.....	2.54
2.5.7	Reset Overload Protection	2.54
2.6	Modulation - General.....	2.55
2.6.1	Modulation Sources.....	2.55
2.6.2	LF Generator	2.57
2.6.3	Simultaneous Modulation	2.57
2.6.4	[MOD ON/OFF] Key	2.58
2.7	Analog Modulations	2.59
2.7.1	Amplitude Modulation.....	2.59
2.7.2	Broadband AM (BB-AM).....	2.60
2.7.3	Frequency Modulation.....	2.61
2.7.3.1	FM Deviation Limits	2.62

2.7.3.2	Preemphasis	2.62
2.7.4	Phase Modulation.....	2.63
2.7.4.1	PM Deviation Limits	2.64
2.7.5	Pulse Modulation.....	2.65
2.8	Vector Modulation	2.66
2.8.1	I/Q Impairment	2.69
2.9	Fading Simulation	2.70
2.9.1	Output Power with Fading.....	2.71
2.9.2	Two-Channel Fading.....	2.71
2.9.3	Correlation between Paths.....	2.72
2.9.4	Menu FADING SIM	2.72
2.9.4.1	Menu STANDARD FADING	2.73
2.9.4.2	Menu FINE DELAY	2.78
2.9.4.3	Menu MOVING DELAY.....	2.81
2.9.4.4	Menu BIRTH-DEATH.....	2.83
2.9.5	Test procedure	2.85
2.10	Digital Modulation	2.86
2.10.1	Digital Modulation Methods and Coding.....	2.87
2.10.1.1	PSK and QAM Modulation	2.87
2.10.1.2	Modulation $\pi/4$ DQPSK.....	2.88
2.10.1.3	FSK Modulation	2.89
2.10.1.4	Coding.....	2.89
2.10.1.5	Setting Conflicts	2.91
2.10.2	Internal Modulation Data and Control Signals from Lists	2.92
2.10.3	Internal PRBS Data and Pattern	2.94
2.10.4	Digital Data and Clock output Signals.....	2.95
2.10.4.1	Serial Interfaces DATA, BIT CLOCK and SYMBOL CLOCK.....	2.95
2.10.4.2	Parallel Interfaces DATA and SYMBOL CLOCK	2.95
2.10.5	External Modulation Data and Control Signals.....	2.95
2.10.5.1	External Serial Modulation Data	2.96
2.10.5.2	External Parallel Modulation Data.....	2.97
2.10.5.3	Asynchronous Interface for External Modulation Data	2.98
2.10.5.4	External Control Signals	2.98
2.10.6	Envelope Control.....	2.99
2.10.7	Clock Signals.....	2.100
2.10.8	RF Level For Digital Modulation	2.100
2.10.9	Digital Modulation Menu.....	2.101
2.11	Digital Standard PHS.....	2.115
2.11.1	Sync and Trigger Signals	2.116
2.11.2	PN Generators as Internal Data Source	2.117
2.11.3	Lists as Internal Data Source	2.118
2.11.4	External Modulation Data.....	2.118
2.11.5	Menu DIGITAL STANDARD - PHS.....	2.119
2.12	Digital Standard IS-95 CDMA.....	2.130
2.12.1	Sync and Trigger Signals	2.133
2.12.2	PRBS Data Source in Forward Link.....	2.134
2.12.3	PN Generators as Internal Data Source for Reverse Link.....	2.135

2.12.4	Menu IS-95 CDMA Standard - Forward Link Signal.....	2.136
2.12.5	Menu IS-95 CDMA Standard - Reverse Link Signal without Channel Coding	2.146
2.12.6	Menu IS-95 CDMA Standard - Reverse Link Signal with Channel Coding	2.148
2.13	Digital Standard W-CDMA (NTT DoCoMo/ARIB 0.0)	2.150
2.13.1	Sync and Trigger Signals	2.152
2.13.2	PN Generators as Internal Data Source	2.153
2.13.3	Lists as an Internal Data Source	2.154
2.13.4	Menu W-CDMA Standard - Downlink and Uplink Signals without IQ Multiplex ...	2.154
2.13.5	Menu W-CDMA Standard - Uplink Signals with IQ Multiplex	2.165
2.14	Digital Standard 3GPP W-CDMA (FDD)	2.169
2.14.1	Description of Mobile Radio Transmission Method 3GPP W-CDMA.....	2.169
2.14.1.1	System Components	2.171
2.14.2	Generation of 3GPP W-CDMA Signals.....	2.177
2.14.2.1	Menu WCDMA/3GPP	2.179
2.14.2.2	WCDMA/3GPP Menu - Para. Predef. Submenu	2.189
2.14.2.3	WCDMA/3GPP Menu - Display of CCDF	2.191
2.14.2.4	WCDMA/3GPP Menu – Displaying Constellation Diagrams	2.192
2.14.2.5	WCDMA/3GPP Menu - BS Configuration Submenu	2.193
2.14.2.6	WCDMA/3GPP Menu - MS Configuration Submenu.....	2.199
2.14.2.7	WCDMA/3GPP – Multi Channel Edit Menu.....	2.208
2.14.2.8	WCDMA/3GPP – Display of Channel Graph Menu	2.210
2.14.2.9	WCDMA/3GPP Menu – Display of Code Domain and Code Domain Conflicts	2.211
2.14.2.10	Effect of CLIPPING LEVEL Parameter on Signal.....	2.213
2.14.2.11	Synchronization and Trigger Signals	2.215
2.14.2.12	Preset/Default Values	2.216
2.14.3	Background Information for the Generation of 3GPP W-CDMA Signals.....	2.219
2.14.3.1	3GPP W-CDMA Signals in Time Domain.....	2.219
2.14.3.2	3GPP W-CDMA Signals in the Frequency Range.....	2.225
2.14.3.3	Effect of Data Source on the 3GPP W-CDMA Signal.....	2.225
2.14.3.3.1	Two DPCHs with Uncorrelated Data	2.226
2.14.3.3.2	Two DPCHs with Same Data	2.226
2.14.3.3.3	16 DPCHs with Uncorrelated Data	2.227
2.14.3.3.4	16 DPCHs with same Data.....	2.228
2.14.3.3.5	Use of Timing Offset	2.229
2.14.3.4	Effects on Crest Factor	2.230
2.14.3.5	Orthogonality of Channels	2.230
2.14.3.5.1	Ideal Scenario.....	2.230
2.14.3.5.2	Real Scenario.....	2.230
2.14.3.5.3	Effect of SCH.....	2.231
2.14.3.5.4	Effect of S-CCPCH and the Other Downlink Channels	2.231
2.14.3.5.5	Effect of PRACH and PCPCH	2.231
2.14.3.5.6	Effect of Scrambling Code	2.232
2.14.3.5.7	Effect of Symbol Rates and Channelization Code Numbers.....	2.232
2.14.3.6	Simulation of Special Scenarios	2.234
2.14.3.6.1	Standard Base Station.....	2.234
2.14.3.6.2	Base Station with More Than 128 DPCHs	2.234
2.14.3.6.3	Base Stations with Spreading Codes Used Several Times.....	2.235
2.14.3.6.4	Several Base Stations	2.235

2.15	Enhanced Functions For Digital Standard 3GPP W-CDMA (FDD)	2.236
2.15.1	Test Setup	2.236
2.15.2	Branching to Menus SMIQB48 of Digital Standard 3GPP WCDMA	2.237
2.15.3	Enhanced Channels BS1/MS1	2.238
2.15.3.1	Downlink	2.240
2.15.3.1.1	P-CCPCH/BCH with System Frame Number	2.241
2.15.3.1.2	Channel Coding	2.243
2.15.3.1.3	Bit Error Insertion	2.244
2.15.3.1.4	External Power Control	2.245
2.15.1.1.5	Further Setting of Enhanced Channels Menu	2.248
2.15.1.2	Uplink	2.253
2.15.1.3	Display of External Power Control Mode of Four Enhanced Channels	2.256
2.15.4	OCNS Channels	2.257
2.15.4.1	OCNS Menu	2.257
2.15.1.2	Test of Maximum Input Level with SMIQ	2.259
2.15.1.3	Favourable Sequence Length for OCNS Measurement	2.260
2.15.5	Additional MS Based On MS4	2.260
2.16	Digital Standard NADC	2.262
2.16.1	Sync and Trigger Signals	2.263
2.16.2	PN Generators as Internal Data Source	2.264
2.16.3	Lists as Internal Data Source	2.265
2.16.4	External Modulation Data	2.265
2.16.5	Menu DIGITAL STANDARD - NADC	2.266
2.17	Digital Standard PDC	2.279
2.17.1	Sync and Trigger Signals	2.280
2.17.2	PN Generators as Internal Data Source	2.281
2.17.3	Lists as Internal Data Source	2.282
2.17.4	External Modulation Data	2.282
2.17.5	Menu DIGITAL STANDARD - PDC	2.283
2.18	Digital Standard GSM/EDGE	2.301
2.18.1	Sync and Trigger Signals	2.302
2.18.2	PN Generators as Internal Data Source	2.303
2.18.3	Lists as Internal Data Source	2.304
2.18.4	External Modulation Data	2.304
2.18.5	Menu DIGITAL STANDARD - GSM/EDGE	2.305
2.19	Digital Standard DECT	2.318
2.19.1	Sync and Trigger Signals	2.319
2.19.2	PN Generators as Internal Data Source	2.320
2.19.3	Lists as Internal Data Source	2.321
2.19.4	External Modulation Data	2.321
2.19.5	Menu DIGITAL STANDARD - DECT	2.322
2.20	Digital Standard GPS	2.334
2.20.1	Description of Global Positioning System (GPS)	2.334
2.20.2	GPS Menu	2.335
2.20.3	Instructions for Generating GPS Signals	2.339

2.21	Arbitrary Waveform Generator ARB	2.341
2.21.1	Function.....	2.341
2.19.1.1	Use of WinIQSIM.....	2.344
2.21.2	ARB MOD Menu.....	2.345
2.21.2.1	ARB MOD - TRIGGER Menu	2.347
2.21.2.2	ARB MOD - SELECT WAVEFORM Menu	2.349
2.21.2.3	ARB MOD - DELETE WAVEFORM Menu	2.352
2.21.2.4	ARB MOD - SET SMIQ ACCORDING TO WAVEFORM Menu	2.352
2.21.2.5	ARB MOD - CLOCK... Menu.....	2.354
2.21.2.6	ARB MOD - IQ OUTPUT... Menu	2.355
2.22	External Modulation Source AMIQ.....	2.356
2.23	Bit Error Rate Test.....	2.368
2.23.1	Bit Error Rate Measurement with PN Sequences (BER)	2.369
2.23.1.1	Operating Menu	2.369
2.23.1.2	Signal Path and Waveform	2.373
2.23.1.3	Test Method	2.374
	PRBS Polynomials.....	2.375
	Measurement Result, Accuracy, Measurement Time.....	2.376
	Possible Problems with BER Measurement and Related Solutions	2.377
2.23.2	Block Error Rate Measurement (BLER)	2.378
2.23.2.1	Operating Menu	2.378
2.23.2.2	CRC Polynomial.....	2.380
2.23.2.3	Measurement Result, Accuracy, Measurement Time.....	2.380
2.23.2.4	Possible BLER Measurement Problems and Solutions.....	2.382
2.24	Noise Generator and Distortion Simulator.....	2.383
2.24.1	Setting NOISE/DIST Menu.....	2.384
2.24.2	Loading New Distortion Characteristics	2.387
2.24.3	Level Correction of the Distortion Simulator.....	2.388
2.24.4	Calculation of the Distortion Characteristic from Polynomial Equations	2.390
2.25	LF Output	2.391
2.26	Sweep	2.392
2.26.1	Setting the Sweep Range (START, STOP, CENTER and SPAN).....	2.392
2.26.2	Selecting the Sweep Run (SPACING LIN, LOG)	2.393
2.26.3	Operating Modes (MODE)	2.393
2.26.4	Trigger Input.....	2.394
2.26.5	Sweep Outputs.....	2.394
2.26.6	RF Sweep.....	2.396
2.26.7	LEVEL Sweep	2.398
2.26.8	LF Sweep	2.399
2.27	LIST Mode	2.401
2.27.1	Operating Modes (MODE)	2.401
2.27.2	Inputs/Outputs.....	2.402
2.28	Memory Sequence.....	2.406

2.29	Utilities.....	2.410
2.29.1	IEC-Bus Address (SYSTEM-GPIB).....	2.410
2.29.2	Parameter of the RS232 Interface (SYSTEM-RS232).....	2.411
2.29.3	Parameter of the SER DATA Input (SYSTEM-SERDATA).....	2.412
2.29.4	Suppressing Indications and Deleting Memories (SYSTEM-SECURITY).....	2.413
2.29.5	Indication of the IEC-Bus Language (LANGUAGE).....	2.414
2.29.6	Reference Frequency Internal/External (REF OSC).....	2.414
2.29.7	Phase of the Output Signal (PHASE).....	2.415
2.29.8	Password Input With Functions Protected (PROTECT).....	2.416
2.29.9	Calibration (CALIB).....	2.417
2.29.10	Indications of Module Variants (DIAG-CONFIG).....	2.424
2.29.11	Voltage Indication of Test Points (DIAG-TPOINT).....	2.425
2.29.12	Measurement of CARRIER/NOISE RATIO (DIAG-C/N MEAS).....	2.426
2.29.13	Indications of Service Data (DIAG-PARAM).....	2.427
2.29.14	Test (TEST).....	2.427
2.29.15	Assigning Modulations to the [MOD ON/OFF] Key (MOD-KEY).....	2.428
2.29.16	Setting Auxiliary Inputs/Outputs (AUX-I/O).....	2.429
2.29.17	Switching On/Off Beeper (BEEPER).....	2.430
2.29.18	Installation of Software Option.....	2.431
2.30	The Help System.....	2.432
2.31	Status.....	2.432
2.32	Error Messages.....	2.433

3	Remote Control.....	3.1
3.1	Brief Instructions.....	3.1
3.1.1	IEC-Bus.....	3.1
3.1.2	RS-232 Interface.....	3.2
3.2	Switchover to Remote Control.....	3.2
3.2.1	Remote Control via IEC Bus.....	3.3
3.2.1.1	Setting the Device Address.....	3.3
3.2.1.2	Indications during Remote Control	3.3
3.2.1.3	Return to Manual Operation.....	3.3
3.2.2	Remote Control via RS-232-Interface.....	3.4
3.2.2.1	Setting the Transmission Parameters	3.4
3.2.2.2	Indications during Remote Control	3.4
3.2.2.3	Return to Manual Operating.....	3.4
3.3	Messages	3.4
3.3.1	Interface Message	3.4
3.3.2	Device Messages (Commands and Device Responses)	3.5
3.4	Structure and Syntax of the Device Messages.....	3.5
3.4.1	SCPI Introduction.....	3.5
3.4.2	Structure of a Command	3.6
3.4.3	Structure of a Command Line.....	3.8
3.4.4	Responses to Queries	3.8
3.4.5	Parameter	3.9
3.4.6	Overview of Syntax Elements.....	3.11
3.5	Description of Commands.....	3.12
3.5.1	Notation.....	3.12
3.5.2	Common Commands.....	3.14
3.5.3	ABORt System.....	3.17
3.5.4	ARB System.....	3.18
3.5.4.1	ARB Waveform Format	3.23
3.5.4.2	Creating a Waveform „Manually“	3.25
3.5.4.3	Converting a Waveform with the Application Software AMIQ-K2.....	3.29
3.5.4.4	AMIQ Compatible Commands for Transmission and Administration of Waveforms	3.29
3.5.5	BERT System	3.30
3.5.6	BLER System.....	3.34
3.5.7	CALibration System	3.37
3.5.8	DIAGnostic System.....	3.40
3.5.9	DISPLAY System.....	3.43
3.5.10	FORMat System	3.44
3.5.11	MEMory System.....	3.45
3.5.12	OUTPut System.....	3.46
3.5.13	OUTPut2 System.....	3.48
3.5.14	SOURce System.....	3.49
3.5.14.1	SOURce:AM Subsystem.....	3.50
3.5.14.2	SOURce:CORRection Subsystem.....	3.51
3.5.14.3	SOURce:DECT Subsystem	3.53

3.5.14.4	SOURce:DiST Subsystem.....	3.61
3.5.14.5	SOURce:DM Subsystem	3.65
	Vector Modulation	3.65
	Digital Modulation	3.67
3.5.14.6	SOURce:FM Subsystem.....	3.78
3.5.14.7	SOURce:FREQuency Subsystem	3.80
3.5.14.8	SOURce:FSIM-Subsystem	3.82
3.5.14.9	SOURce:GPS Subsystem	3.93
3.5.14.10	SOURce:GSM Subsystem (Digital Standard GSM/EDGE)	3.96
3.5.14.11	SOURce:IS95 Subsystem (Digital Standard IS-95 CDMA)	3.102
3.5.14.12	SOURce:LIST Subsystem	3.110
3.5.14.13	SOURce:MARKer Subsystem	3.112
3.5.14.14	SOURce:MODulation Subsystem	3.114
3.5.14.15	SOURce:NADC Subsystem.....	3.115
3.5.14.16	SOURce:NOISe Subsystem	3.123
3.5.14.17	SOURce:PDC Subsystem	3.124
3.5.14.18	SOURce:PHASe Subsystem	3.133
3.5.14.19	SOURce:PHS Subsystem.....	3.134
3.5.14.20	SOURce:PM Subsystem.....	3.142
3.5.14.21	SOURce:POWer Subsystem	3.144
3.5.14.22	SOURce:PULM Subsystem	3.147
3.5.14.23	SOURce:ROSCillator Subsystem	3.148
3.5.14.24	SOURce:SWEep Subsystem.....	3.149
3.5.14.25	SOURce:WCDMa Subsystem (NTT DoCoMo/ARIB 0.0)	3.152
3.5.14.26	SOURce:W3GPP-Subsystem	3.159
3.5.14.27	SOURce:W3GPP:ENHanced/OCNS/ADDITIONal Subsystems	3.180
3.5.15	SOURce2 System.....	3.194
	3.5.15.1 SOURce2:FREQuency Subsystem	3.194
	3.5.15.2 SOURce2:MARKer Subsystem	3.196
	3.5.15.3 SOURce2:SWEep Subsystem.....	3.197
3.5.16	STATus System.....	3.199
3.5.17	SYSTem System	3.201
3.5.18	TEST System.....	3.207
3.5.19	TRIGger System	3.210
3.5.20	UNIT System	3.215
3.6	Instrument Model and Command Processing	3.215
3.6.1	Input Unit.....	3.215
3.6.2	Command Recognition	3.216
3.6.3	Data Set and Instrument Hardware	3.216
3.6.4	Status Reporting System	3.216
3.6.5	Output Unit.....	3.217
3.6.6	Command Sequence and Command Synchronization.....	3.217
3.7	Status Reporting System.....	3.218
3.7.1	Structure of an SCPI Status Register	3.218
3.7.2	Overview of the Status Registers	3.220
3.7.3	Description of the Status Registers	3.221
	3.7.3.1 Status Byte (STB) and Service Request Enable Register (SRE)	3.221
	3.7.3.2 IST Flag and Parallel Poll Enable Register (PPE)	3.222
	3.7.3.3 Event Status Register (ESR) and Event Status Enable Register (ESE).....	3.222
	3.7.3.4 STATus:OPERation Register	3.223
	3.7.3.5 STATus:QUESTionable Register.....	3.224

3.7.4	Application of the Status Reporting Systems.....	3.225
3.7.4.1	Service Request, Making Use of the Hierarchy Structure	3.225
3.7.4.2	Serial Poll.....	3.225
3.7.4.3	Parallel Poll	3.226
3.7.4.4	Query by Means of Commands	3.226
3.7.4.5	Error Queue Query	3.226
3.7.5	Resetting Values of the Status Reporting Systems	3.227
3.8	Fast Restore Mode	3.228
3.8.1	Commands	3.228
3.8.2	Call-Up and Termination of Operating Mode	3.229
3.8.3	Effects on Device Settings	3.229
3.8.4	Alternative Use with Other IEC/IEEE-Bus Commands	3.230
3.8.5	Synchronization Signal.....	3.230
4	Maintenance and Troubleshooting	4.2
4.1	Maintenance	4.2
4.1.1	Cleaning the Outside.....	4.2
4.1.2	Storage.....	4.2
4.2	Functional Test	4.2

5	Checking the Rated Characteristics	5.2
5.1	Test Equipment and Test Assemblies.....	5.2
5.1.1	Measuring Equipment and Accessories.....	5.2
5.1.2	Test Assemblies.....	5.3
5.1.2.1	Standard Test Assembly for Analog Modulations.....	5.3
5.1.2.2	Test Assembly for Analog Modulations with Audio Analyzer.....	5.5
5.1.2.3	Test Assembly for Broadband FM.....	5.5
5.1.2.4	Test Assembly for Pulse Modulation.....	5.6
5.1.2.5	Test Assembly for Vector Modulation.....	5.6
5.1.2.6	Test Assembly for SSB Phase Noise.....	5.7
5.1.2.7	Test Assembly for Output Impedance (VSWR).....	5.7
5.1.2.8	Test Assembly with Spectrum Analyzer for Fading Simulation.....	5.8
5.1.2.9	Test Assembly with Sampling Oscilloscope for Fading Simulation.....	5.8
5.1.2.10	Test Assembly for Amplitude Settling.....	5.8
5.2	Preparation, Recommended Test Frequencies and Levels	5.9
5.3	Test Procedures	5.10
5.3.1	Display and Keyboard.....	5.10
5.3.2	Frequency.....	5.10
5.3.2.1	Frequency Setting.....	5.10
5.3.1.2	Settling Time.....	5.12
5.3.1.3	Setting Time LIST MODE.....	5.14
5.3.3	Reference Frequency.....	5.15
5.3.1.1	Output of Internal Reference.....	5.15
5.3.1.2	Input for External Reference.....	5.15
5.3.4	Level.....	5.15
5.3.4.1	Level Uncertainty.....	5.15
5.31.1.2	Output Impedance.....	5.17
5.3.1.3	Settling Time.....	5.18
5.31.1.4	Non-Interrupting Level Setting (ATTENUATOR MODE FIXED).....	5.20
5.3.1.5	Overvoltage Protection (if provided).....	5.21
5.3.5	Spectral Purity.....	5.21
5.3.5.1	Harmonics.....	5.21
5.3.1.2	Subharmonics.....	5.22
5.3.1.3	Nonharmonics.....	5.22
5.3.1.4	Broadband Noise.....	5.25
5.3.1.5	SSB Phase Noise.....	5.26
5.3.1.6	Residual FM.....	5.27
5.3.1.7	Residual AM.....	5.27
5.3.6	Sweep.....	5.27
5.3.7	Internal Modulation Generator.....	5.28
5.3.8	Vector Modulation.....	5.29
5.3.8.1	Input Impedance (VSWR).....	5.29
5.3.1.2	Maximum Level.....	5.29
5.3.1.3	Error Vector.....	5.30
5.3.1.4	Modulation Frequency Response.....	5.30
5.3.1.5	Residual Carrier and Leakage.....	5.31
5.3.1.6	I/Q Imbalance.....	5.32
5.3.1.7	Level Control POW RAMP.....	5.33
5.3.9	Amplitude Modulation.....	5.35
5.3.9.1	Modulation Depth Setting.....	5.35

5.3.9.2	AM Distortion	5.35
5.3.9.3	AM Frequency Response	5.35
5.3.9.4	Residual PhiM with AM	5.36
5.3.9.5	Level Monitoring at Input EXT1	5.36
5.3.10	Broadband Amplitude Modulation	5.37
5.3.11	Pulse Modulation	5.37
5.3.11.1	ON/OFF Ratio	5.37
5.3.11.2	Dynamic Characteristics	5.38
5.3.12	Frequency Modulation (Option SM-B5)	5.38
5.3.12.1	FM Deviation Setting	5.38
5.3.12.2	FM Distortion	5.39
5.3.12.3	FM Frequency Response	5.40
5.3.12.4	FM Preemphasis (optional)	5.41
5.3.12.5	Residual AM with FM	5.41
5.3.12.6	Carrier Frequency Error with FM	5.41
5.3.12.7	Level Monitoring at Input EXT2	5.42
5.3.13	Phase Modulation (Option SM-B5)	5.42
5.3.13.1	Deviation Setting	5.42
5.3.13.2	PhiM Distortion	5.42
5.3.13.3	PhiM Frequency Response	5.43
5.3.14	Digital Modulation (Option SMIQB20)	5.43
5.3.14.1	Level Error and Residual Carrier with Digital Modulation	5.43
5.3.14.2	Analog Outputs with Digital Modulation	5.44
5.3.14.3	Modulation Depth with ASK	5.44
5.3.14.4	Deviation Error with FSK	5.44
5.3.14.5	Deviation Error with GFSK	5.45
5.3.14.6	Phase Error with GMSK	5.45
5.3.14.7	Error Vector with PSK	5.45
5.3.14.8	Error Vector with QAM	5.45
5.3.15	Data Generator and Memory Extension (Option SMIQB11/SMIQB12)	5.46
5.3.15.1	Battery Test	5.46
5.3.15.2	Function Test	5.46
5.3.15.3	Interface SERDATA	5.48
5.3.15.4	Memory Test (including SMIQB12)	5.49
5.3.16	Digital Standards (Options)	5.51
5.3.16.1	Adjacent-Channel Power Measurement with Higher Resolution	5.51
5.1.16.1.1	Broadband Systems	5.51
5.1.16.1.2	Narrowband Systems	5.52
5.3.16.2	GSM/EDGE	5.52
5.3.16.3	DECT	5.53
5.3.16.4	NADC	5.55
5.3.16.5	TETRA	5.55
5.3.16.6	PDC	5.56
5.3.16.7	PHS	5.57
5.3.17	IS-95 CDMA (Option SMIQB42)	5.58
5.3.18	W-CDMA - NTT DoCoMo/ARIB 0.0 (Option SMIQB43)	5.59
5.3.19	3GPP W-CDMA for SMIQ with firmware version up to 5.20 (Options SMIQB20 and SMIQB45)	5.60
5.1.19.1	3GPP W-CDMA with 1 Code Channel	5.60
5.1.19.2	3GPP W-CDMA with 8 Code Channels	5.62
5.3.20	3GPP W-CDMA for SMIQ with Firmware Versions 5.30 or Higher (Options SMIQB20 and SMIQB45)	5.64
5.3.20.1	3GPP W-CDMA with 1 Code Channel	5.64

5.3.20.2	3GPP W-CDMA with 8 Code Channels.....	5.67
5.3.20.3	3GPP W-CDMA Test Model 1, 64 DPCH.....	5.68
5.3.21	3GPP W-CDMA Enhanced Channels (SMIQB48).....	5.69
5.3.21.1	External Power Control.....	5.69
5.3.22	Bit Error Rate Test (Option SMIQB21).....	5.70
5.3.23	Fading Simulation (Option SMIQB14/SMIQB15).....	5.72
5.3.23.1	Frequency Response.....	5.72
5.3.23.2	Additional Modulation Frequency Response.....	5.73
5.3.23.3	Carrier Leakage for Fading.....	5.73
5.3.23.4	Path Attenuation.....	5.73
5.3.23.5	Path Delay (optional).....	5.76
5.3.23.6	Doppler Shift (optional).....	5.77
5.3.24	Noise Generation and Distortion Simulation (Option SMIQB17).....	5.78
5.3.24.1	RF Bandwidth.....	5.78
5.3.24.2	Additional Modulation Frequency Response.....	5.80
5.3.24.3	Residual Carrier.....	5.80
5.3.24.4	Frequency Response through to I-FADED, Q-FADED Outputs.....	5.81
5.3.24.5	Signal/Noise Ratio (Carrier/Noise Ratio).....	5.82
5.3.24.6	Signal/Noise Ratio (Carrier/Noise Ratio) Worldspace.....	5.84
5.3.24.7	Error Vector.....	5.84
5.3.24.8	Noise Frequency Response.....	5.85
5.3.25	Arbitrary Waveform Generator (ARB, Option SMIQB60).....	5.86
5.3.25.1	Frequency Response.....	5.86
5.3.25.2	DC Voltage Offset.....	5.87
5.3.25.3	Spurious-Free Dynamic Range (SFDR).....	5.87
5.3.25.4	Level Difference of Channels.....	5.89
5.3.26	Additional Measurements for SMIQ03S.....	5.90
5.4	Performance Test Report.....	5.92
A	Annex A.....	A.2
A.1	IEC/IEEE Bus Interface.....	A.2
A.1.1	Characteristics of the Interface.....	A.2
A.1.2	Bus Lines.....	A.2
A.1.3	Interface Functions.....	A.3
A.1.4	Interface Messages.....	A.4
A.2	RS-232-C Interface.....	A.5
A.2.1	Interface characteristics.....	A.5
A.2.2	Signal lines.....	A.5
A.2.2.1	Transmission parameters.....	A.6
A.2.3	Interface functions.....	A.6
A.2.3.1	Handshake.....	A.7
A.3	Asynchronous Interface SERDATA.....	A.8
B	Annex B.....	B.2
B.1	List of Error Messages.....	B.2
B.1.1	SCPI-Specific Error Messages.....	B.2
B.1.2	SMIQ-Specific Error Messages.....	B.6

C Annex C	C.1
C.1 List of Commands (with SCPI Conformity Information)	C.1
D Annex D	D.1
D.1 Programming Examples	D.1
1. Including IEC-Bus Library for QuickBasic	D.1
2. Initialization and Default Status	D.1
2.1. Initiate Controller	D.1
2.2. Initiate Instrument	D.1
3. Transmission of Instrument Setting Commands	D.2
4. Switchover to Manual Control	D.2
5. Reading out Instrument Settings	D.2
6. List Management	D.3
7. Command synchronization	D.3
8. Service Request	D.4

10 Index

Tables

Table 2-1	Input sockets for the different types of modulation.....	2.55
Table 2-2	Status messages in the case of a deviation from the rated value at the external modulation inputs EXT1 and EXT2.....	2.56
Table 2-3	Parameter setting ranges.....	2.69
Table 2-4	Phase shifts for $\pi/4$ DQPSK without coding.....	2.87
Table 2-5	Phase shifts for $\pi/4$ DQPSK with coding NADC, PDC, PHS, TETRA or APCO25.....	2.87
Table 2-6	Phase shifts for $\pi/4$ DQPSK with coding TFTS.....	2.87
Table 2-7	Frequency deviations for FSK methods.....	2.88
Table 2-8	Possible combination of modulation method and coding.....	2.88
Table 2-9	Coding algorithms.....	2.89
Table 2-10	Examples of settings conflicts	2.90
Table 2-11	PRBS generators of modulation coder.....	2.93
Table 2-12	Logic function of signals BURST GATE and LEVEL ATT.....	2.98
Table 2-13	PRBS generators for PHS	2.116
Table 2-14	CDMA: channel numbers and their frequencies.....	2.131
Table 2-15	Preferred CDMA-frequency channels according to J-STD-008.....	2.131
Table 2-16	PN generators for IS-95 reverse link.....	2.134
Table 2-17	PN generators for W-CDMA	2.152
Table 2-18	Parameters of W-CDMA system	2.169
Table 2-19	Generator polynomials of uplink long scrambling code generators.....	2.171
Table 2-20	Generator polynomials of uplink short scrambling code generators.....	2.172
Table 2-21	Mapping of the quaternary output sequence into the binary IQ level.....	2.172
Table 2-22	Hierarchical structure of 3GPP W-CDMA frames.....	2.174
Table 2-23	Structure of the DPDCH channel table depending on the overall symbol rate.....	2.206
Table 2-24	Change of crest factor in the case of clipping.....	2.213
Table 2-25	Default values for base station parameters.....	2.216
Table 2-26	Default values for mobile station parameters.....	2.217
Table 2-27	References to measurement channels.....	2.241
Table 2-28	OCNS channels	2.256
Table 2-29	PRBS generators for NADC	2.261
Table 2-30	PRBS generators for PDC	2.278
Table 2-31	PRBS generators for GSM	2.300
Table 2-32	PRBS generators for DECT	2.317
Table 2-33	LIST mode; Example of a list	2.393
Table 2-35	MEMORY SEQUENCE; Example of a list.....	2.398
Table 3-1	Common Commands.....	3.14
Table 3-2	List of possible responses to *OPT?.....	3.15
Table 3-3	Synchronization with *OPC, *OPC? and *WAI.....	3.213
Table 3-4	Meaning of the bits used in the status byte.....	3.217
Table 3-5	Meaning of the bits used in the event status register.....	3.218
Table 3-6	Meaning of the bits used in the STATus:OPERation register.....	3.219
Table 3-7	Meaning of the bits used in the STATus:QUEStionable register.....	3.220
Table 3-8	Resetting instrument functions.....	3.223
Table 5-1	Measuring equipment and accessories.....	5.1
Table 5-2	Range limits, main test frequencies with/without vector modulation.....	5.7
Table A-1	Interface function.....	A.2
Table A-2	Universal Commands.....	A.3
Table A-3	Addressed Commands.....	A.3
Table A-4	Interface functions (RS-232-C).....	A.5

Figures

Fig. 1-1	SMIQ, view from the top	1.5
Fig. 1-2	Module FSIM.....	1.9
Fig. 1-3	Module NDSIM.....	1.13
Fig. 1-4	Module MCODE	1.14
Fig. 2-1	Front panel view.....	2.2
Fig. 2-2	Rear panel view	2.12
Fig. 2-3	Design of the display.....	2.22
Fig. 2-4	MODULATION-AM menu	2.23
Fig. 2-5	Display after AM setting	2.29
Fig. 2-6	Display after pattern setting	2.31
Fig. 2-7	OPERATION page of the MEM SEQ menu.....	2.32
Fig. 2-8	SELECT-LIST-selection window.....	2.33
Fig. 2-9	DELETE-LIST selection window	2.34
Fig. 2-10	Edit function EDIT/VIEW	2.35
Fig. 2-11	Block function FILL: Input window	2.36
Fig. 2-12	Edit function INSERT: Input window	2.38
Fig. 2-13	Edit function DELETE: Input window	2.39
Fig. 2-14	Starting point of the pattern setting	2.40
Fig. 2-15, a to c	Pattern setting - Edition of a list	2.42
Fig. 2-16	Menu FREQUENCY (preset setting)	2.45
Fig. 2-17	Example of a circuit with frequency offset	2.46
Fig. 2-18	Menu LEVEL (preset setting) POWER RESOLUTION is set to 0.01 dB.....	2.47
Fig. 2-19	Example of a circuit with level offset.....	2.49
Fig. 2-20	Menu LEVEL - ALC (preset setting)	2.51
Fig. 2-21	Menu LEVEL - UCOR - OPERATION side.....	2.52
Fig. 2-22	Menu UCOR - LEVEL-EDIT side.....	2.53
Fig. 2-23	Menu LEVEL-EMF	2.53
Fig. 2-24	Example: Status message "EXT1-LOW" in case of voltage at EXT1 too low	2.56
Fig. 2-25	Example: Settings of the LF generator in the AM menu.....	2.57
Fig. 2-26	Menu ANALOG MOD-AM (preset setting).....	2.59
Fig. 2-27	Menu ANALOG MOD - BB-AM (preset setting).....	2.60
Fig. 2-28	Menu ANALOG MOD-FM (preset setting), fitted with option SM-B5, FM/PM-modulator	2.61
Fig. 2-29	Dependency of the FM maximal deviation on the RF frequency set	2.62
Fig. 2-30	Menu ANALOG MOD - PM (preset setting), fitted with option SM-B5, FM/PM- modulator	2.63
Fig. 2-31	Dependency of the PM maximal deviation on the RF frequency set	2.64
Fig. 2-32	Menu MODULATION-PULSE (preset setting), fitted with option SM-B3, pulse modulator, and option SM-B4, pulse generator	2.65
Fig. 2-33	Example: vector modulation	2.66
Fig. 2-34	VECTOR MOD menu (preset settings), equipped with option SMIQB47 and IQMOD var. 8 or higher	2.67
Fig. 2-35	Effect of I/Q impairment.....	2.69
Fig. 2-36	Fading simulator in the SMIQ	2.70
Fig. 2-37	Two-channel fading	2.71
Fig. 2-38	Menu FADING SIM with submenus.....	2.72
Fig. 2-39	Menu STANDARD FADING (two Fading Simulators installed)	2.73
Fig. 2-40	Doppler Frequency shift with moving receiver	2.76
Fig. 2-41	Menu FINE DELAY	2.78
Fig. 2-42	Two paths with menu MOVING DELAY	2.80
Fig. 2-43	Menu MOVING DELAY.....	2.80
Fig. 2-44	Example of hop sequence with BIRTH-DEATH fading.....	2.82
Fig. 2-45	Menu BIRTH-DEATH.....	2.82

Fig. 2-46	Pulse on Oscilloscope	2.84
Fig. 2-47	Modulation coder in SMIQ	2.85
Fig. 2-48	Digital input signals of modulation coder	2.85
Fig. 2-49	Functional blocks Coding and Mapping	2.86
Fig. 2-50	Constellation diagrams of BPSK, QPSK, 8PSK and 16QAM	2.86
Fig. 2-51	DATA LIST for modulation data	2.91
Fig. 2-52	CONTROL LIST for control signals	2.92
Fig. 2-53	9-bit PRBS generator	2.93
Fig. 2-54	External serial data and bit clock Data change should take place only on the negative clock edge.	2.95
Fig. 2-55	External serial data and symbol clock, 3 bit/symbol SYMBOL CLOCK = High marks the LSB. A status change of DATA and SYMBOL CLOCK should be performed synchronously.....	2.95
Fig. 2-56	External serial data, internal clock signals	2.95
Fig. 2-57	External parallel data and symbol clock Data change should take place only on the negative clock edge.	2.96
Fig. 2-58	External parallel data and symbol clock SYMBOL CLOCK = High marks the LSB. A status change of DATA and SYMBOL CLOCK should be performed synchronously.....	2.96
Fig. 2-59	Envelope control in SMIQ with modulation coder	2.98
Fig. 2-60	Signal waveforms during envelope control	2.99
Fig. 2-61	DIGITAL MOD menu, SMIQ equipped with option Modulation Coder SMIQB20 and option Data Generator SMIQB11	2.100
Fig. 2-62	DIGITAL MOD-SOURCE menu, SMIQ equipped with option Modulation Coder SMIQB20 and option Data Generator SMIQB11	2.100
Fig. 2-63	DIGITAL MOD - MODULATION... menu, SMIQ equipped with option Modulation Coder SMIQB20 and option Data Generator SMIQB11	2.103
Fig. 2-64	DIGITAL MOD -FILTER... menu, SMIQ equipped with option Modulation Coder SMIQB20 and option Data Generator SMIQB11	2.105
Fig. 2-65	DIGITAL MOD - TRIGGER menu, SMIQ equipped with option Modulation Coder SMIQB20 and option Data Generator SMIQB11	2.108
Fig. 2-66	DIGITAL MOD - CLOCK, SMIQ equipped with option Modulation Coder SMIQB20 and option Data Generator SMIQB11	2.109
Fig. 2-67	DIGITAL MOD - POWER RAMP CONTROL menu, SMIQ equipped with option Modulation Coder SMIQB20 and option Data Generator SMIQB11	2.111
Fig. 2-68	DIGITAL MOD - EXT INPUTS menu, SMIQ equipped with option Modulation Coder SMIQB20 and option Data Generator SMIQB11	2.112
Fig. 2-69	Menu DIGITAL STD - PHS, SMIQ equipped with Modulation Coder SMIQB20 and Data Generator SMIQB11	2.118
Fig. 2-70	Menu DIGITAL STD - PHS - MODULATION..., SMIQ equipped with Modulation Coder SMIQB20 and Data Generator SMIQB11	2.118
Fig. 2-71	Menu DIGITAL STD - PHS_TRIGGER..., SMIQ equipped with Modulation Coder SMIQB20 and Data Generator SMIQB11	2.120
Fig. 2-72	Menu DIGITAL STD - PHS - CLOCK..., SMIQ equipped with Modulation Coder SMIQB20 and Data Generator SMIQB11	2.122
Fig. 2-73	Menu DIGITAL STD - PHS - POWER RAMP CONTROL... , SMIQ equipped with Modulation Coder SMIQB20 and Data Generator SMIQB11	2.123
Fig. 2-74	Menu DIGITAL STD - PHS - SAVE/RCL FRAME, SMIQ equipped with Modulation Coder SMIQB20 and Data Generator SMIQB11	2.124
Fig. 2-75	Menu DIGITAL STD - PHS - SELECT SLOT, SMIQ equipped with Modulation Coder SMIQB20 and Data Generator SMIQB11	2.125
Fig. 2-76	Forward link signal generation	2.129
Fig. 2-77	Reverse link signal generation without channel coding	2.130
Fig. 2-78	Traffic channel 9600 in "Reverse Link Coded" mode	2.130
Fig. 2-79	Frame structure of traffic channel 9600 in "Reverse Link Coded" mode.....	2.131
Fig. 2-80	CDMA sync signals	2.132

Fig. 2-81	Menu DIGITAL STD - IS-95 - MODE - FWD_LINK_18, equipped with options modulation coder SMIQB20, data generator SMIQB11 and SMIQB42	2.135
Fig. 2-82	Menu DIGITAL STD - IS-95 - MODULATION..., equipped with options modulation coder SMIQB20, data generator SMIQB11 and SMIQB42	2.137
Fig. 2-83	Menu DIGITAL STD - IS-95 - TRIGGER..., equipped with options modulation coder SMIQB20, data generator SMIQB11 and SMIQB42.....	2.139
Fig. 2-84	Menu DIGITAL STD - IS-95 - CLOCK..., equipped with options modulation coder SMIQB20, data generator SMIQB11 and SMIQB42.....	2.141
Fig. 2-85	Menu DIGITAL STD - IS-95 - SAVE/RCL MAPPING..., equipped with options modulation coder SMIQB20, data generator SMIQB11 and SMIQB42	2.143
Fig. 2-86	Menu DIGITAL STD - IS-95 - MODE - REV_LINK	2.145
Fig. 2-87	Menu DIGITAL STD - IS-95 - MODE - REV_LINK_CODED	2.147
Fig. 2-88	Downlink DPCH signal generation for a code channel	2.149
Fig. 2-89	Uplink signal generation with IQ multiplex and several code channels	2.150
Fig. 2-90	Menu DIGITAL STD - WCDMA - MODE - 8CHAN, LINK DIRECTION/MULTIPLEX - DOWN, equipped with options modulation coder SMIQB20, data generator SMIQB11 and SMIQB43.....	2.153
Fig. 2-91	Menu DIGITAL STD - WCDMA - MODULATION..., equipped with options modulation coder SMIQB20, data generator SMIQB11 and SMIQB43	2.156
Fig. 2-92	Menu DIGITAL STD - WCDMA - TRIGGER..., equipped with options modulation coder SMIQB20, data generator SMIQB11 and SMIQB43	2.158
Fig. 2-93	Menu DIGITAL STD - WCDMA - MULTICODE..., equipped with options modulation coder SMIQB20, data generator SMIQB11 and SMIQB43	2.160
Fig. 2-94	Menu DIGITAL STD - WCDMA - SPREAD CODE; equipped with options modulation coder SMIQB20, data generator SMIQB11 and SMIQB43	2.161
Fig. 2-95	Menu DIGITAL STD - WCDMA - DATA; equipped with options modulation coder SMIQB20, data generator SMIQB11 and SMIQB43.....	2.162
Fig. 2-96	Menu DIGITAL STD - WCDMA - MODE - 8CHAN, -LINK DIRECTION/MULTIPLEX - UP_IQ_MULT, equipped with options modulation coder SMIQB20, data generator SMIQB11 and SMIQB43.....	2.164
Fig. 2-98	Structure of the downlink scrambling code generator	2.171
Fig. 2-99	Structure of the uplink short scrambling code generator	2.172
Fig. 2-100	Constellation diagram of a channel with 0 dB power	2.173
Fig. 2-101	Constellation diagram of a channel with -6 dB power	2.175
Fig. 2-102	Constellation diagram of a 3GPP W-CDMA signal with two DPCH channels	2.176
Fig. 2-103	Overview of DIGITAL STD – 3GPP WCDMA/3GPP menu structure	2.177
Fig. 2-104	DIGITAL STD - WCDMA/3GPP - Downlink menu.....	2.178
Fig. 2-105	DIGITAL STD - WCDMA/3GPP - FILTER... menu.....	2.180
Fig. 2-106	DIGITAL STD - WCDMA/3GPP - Downlink - COPY BS(MS) menu.....	2.182
Fig. 2-107	DIGITAL STD – WCDMA/3GPP – TRIGGER... menu	2.183
Fig. 2-108	DIGITAL STD – WCDMA/3GPP – SELECT BS(MS) menu	2.185
Fig. 2-109	DIGITAL STD - WCDMA/3GPP - PARA. PREDEF. menu (only downlink)	2.186
Fig. 2-110	DIGITAL STD – WCDMA/3GPP – CCDF menu with a trace	2.187
Fig. 2-111	Reading off the crest factor from LEVEL displays	2.187
Fig. 2-112	DIGITAL STD – WCDMA/3GPP – CCDF menu with three traces	2.187
Fig. 2-113	DIGITAL STD - WCDMA/3GPP – CONSTELLATION menu	2.188
Fig. 2-114	DIGITAL STD - WCDMA/3GPP - BS CONFIGURATION menu	2.189
Fig. 2-115	Dynamic change of channel power (continuous).....	2.191
Fig. 2-116	DIGITAL STD – WCDMA/3GPP – BS CONFIGURATION / channel table menu ..	2.192
Fig. 2-117	DIGITAL STD – WCDMA/3GPP – MS CONFIGURATION menu.....	2.194
Fig. 2-118	DIGITAL STD – WCDMA/3GPP – MS CONFIGURATION: PRACH only Mode menu.....	2.197
Fig. 2-119	DIGITAL STD – WCDMA/3GPP – MS CONFIGURATION: PCPCH only Mode menu.....	2.198

Fig. 2-120	DIGITAL STD – WCDMA/3GPP – MS CONFIGURATION: DPCCH + DPDCH Mode menu.....	2.200
Fig. 2-121	Dynamic change of channel power (continuous).....	2.201
Fig. 2-122	DIGITAL STD – WCDMA/3GPP – BS CONFIGURATION / MULTI CHANNEL EDIT menu.....	2.203
Fig. 2-123	DIGITAL STD – WCDMA/3GPP – BS CONFIGURATION /CHANNEL GRAPH menu.....	2.205
Fig. 2-124	Code tree of channelization codes.....	2.206
Fig. 2-125	WCDMA/3GPP – BS CONFIGURATION / CODE DOMAIN menu (without conflict).....	2.206
Fig. 2-126	WCDMA/3GPP – BS CONFIGURATION / CODE DOMAIN menu (with conflict).....	2.207
Fig. 2-127	WCDMA/3GPP – BS CONFIGURATION / CODE DOMAIN CONFLICT menu.....	2.207
Fig. 2-128	WCDMA/3GPP – BS CONFIGURATION / CODE DOMAIN menu (after conflict resolution).....	2.208
Fig. 2-129	Constellation at clipping level 100% (not clipped).....	2.209
Fig. 2-130	Constellation at clipping level 50%.....	2.209
Fig. 2-131	Signal consisting of P-CCPCH, P-SCH and S-SCH in time domain.....	2.214
Fig. 2-132	Signal consisting of P-CCPCH, P-SCH and S-SCH in time domain (zoomed).....	2.214
Fig. 2-133	Constellation diagram of a signal consisting of P-CCPCH, P-SCH and S-SCH.....	2.215
Fig. 2-134	Envelope of P-CCPCH.....	2.215
Fig. 2-135	Envelope of P-SCH or S-SCH.....	2.216
Fig. 2-136	Envelope of AICH (Subchannel).....	2.216
Fig. 2-137	Envelope of AICH (four subchannels).....	2.216
Fig. 2-138	Envelope of DL-DPCCH.....	2.216
Fig. 2-139	Envelope of DPCH 60 kbps without TFCI.....	2.216
Fig. 2-140	Constellation of a DPDCH/DPCCH channel.....	2.217
Fig. 2-141	Constellation of an uplink signal consisting of a DPDCH and a DPCCH.....	2.217
Fig. 2-142	Constellation of a PRACH.....	2.218
Fig. 2-143	Envelope of a PRACH.....	2.218
Fig. 2-144	Envelope of a PCPCH.....	2.218
Fig. 2-145	Magnitude spectrum of a 3GPP W-CDMA signal.....	2.219
Fig. 2-146	Magnitude spectrum (section) of a 3GPP W-CDMA signal with several channels.....	2.219
Fig. 2-147	Constellation of a signal with two DPCHs (uncorrelated data).....	2.220
Fig. 2-148	Signal with two DPCHs (same data) in time domain.....	2.220
Fig. 2-149	Constellation of a signal with two DPCHs (uncorrelated data).....	2.221
Fig. 2-150	Constellation with 16 uncorrelated channels (16 time slots).....	2.221
Fig. 2-151	Constellation with 16 uncorrelated channels (1 time slot).....	2.222
Fig. 2-152	Constellation diagram of 16 DPCHs with same data.....	2.222
Fig. 2-153	Constellation diagram of 16 DPCHs with timing offset.....	2.223
Fig. 2-154	CDPA of a signal with compensated SCH.....	2.225
Fig. 2-155	Effect of SCH on CDP analysis (without compensation).....	2.225
Fig. 2-156	Effect of different scrambling codes on the power distribution.....	2.226
Fig. 2-157	Cancellation possible in case of several channels with identical spreading sequences.....	2.226
Fig. 2-158	Incorrect detection at various symbol rates.....	2.227
Fig. 2-159	Non-restorable DPCH channel.....	2.227
Fig. 2-160	Complete setup for testing a W-CDMA receiver with SMIQ.....	2.230
Fig. 2-161	Menu DIGITAL STD – WCDMA/3GPP – Section Assistant/Enhanced Functions (downlink).....	2.231
Fig. 2-162	Menu DIGITAL STD – WCDMA/3GPP – Section Assistant/Enhanced Functions (uplink).....	2.231
Fig. 2-163	Menu DIGITAL STD-WCDMA/3GPP-ENHANCED CHANNEL (downlink).....	2.233
Fig. 2-164	Setup for testing Closed Loop Power Control.....	2.236
Fig. 2-165	Change of channel power of 4 enhanced channels.....	2.237
Fig. 2-166	DIGITAL STD - WCDMA/3GPP - ENHANCED CHANNELS STATE (uplink) menu.....	2.243
Fig. 2-167	Display of external power control mode.....	2.245

Fig. 2-168	DIGITAL STD - WCDMA/3GPP - OCNS CHANNELS menu	2.246
Fig. 2-169	DIGITAL STD - WCDMA/3GPP ADDITIONAL MS STATE menu.....	2.249
Fig. 2-170	Menu DIGITAL STD - NADC, SMIQ equipped with Modulation Coder SMIQB20 and Data Generator SMIQB11	2.255
Fig. 2-171	Menu DIGITAL STD - NADC - MODULATION..., SMIQ equipped with Modulation Coder SMIQB20 and Data Generator SMIQB11	2.255
Fig. 2-172	Menu DIGITAL STD - NADC_TRIGGER..., SMIQ equipped with Modulation Coder SMIQB20 and Data Generator SMIQB11	2.257
Fig. 2-173	Menu DIGITAL STD - NADC - CLOCK..., SMIQ equipped with Modulation Coder SMIQB20 and Data Generator SMIQB11	2.258
Fig. 2-174	Menu DIGITAL STD - NADC - POWER RAMP CONTROL... , SMIQ equipped with Modulation Coder SMIQB20 and Data Generator SMIQB11	2.259
Fig. 2-175	Menu DIGITAL STD - NADC - SAVE/RCL FRAME, SMIQ equipped with Modulation Coder SMIQB20 and Data Generator SMIQB11	2.261
Fig. 2-176	Menu DIGITAL STD - NADC - SELECT SLOT, LINK DIRECTION = DOWNLINK, SMIQ equipped with Modulation Coder SMIQB20 and Data Generator SMIQB11	2.262
Fig. 2-177	Menu DIGITAL STD - NADC - SELECT SLOT, LINK DIRECTION = UPLINK, SMIQ equipped with Modulation Coder SMIQB20 and Data Generator SMIQB11	2.265
Fig. 2-178	Menu DIGITAL STD - NADC - SELECT SLOT, SMIQ equipped with Modulation Coder SMIQB20 and Data Generator SMIQB11	2.266
Fig. 2-179	Menu DIGITAL STD - PDC, SMIQ equipped with Modulation Coder SMIQB20 and Data Generator SMIQB11	2.272
Fig. 2-180	Menu DIGITAL STD - PDC - MODULATION..., SMIQ equipped with Modulation Coder SMIQB20 and Data Generator SMIQB11	2.272
Fig. 2-181	Menu DIGITAL STD - PDC_TRIGGER..., SMIQ equipped with Modulation Coder SMIQB20 and Data Generator SMIQB11	2.274
Fig. 2-182	Menu DIGITAL STD - PDC - CLOCK..., SMIQ equipped with Modulation Coder SMIQB20 and Data Generator SMIQB11	2.275
Fig. 2-183	Menu DIGITAL STD - PDC - POWER RAMP CONTROL... , SMIQ equipped with Modulation Coder SMIQB20 and Data Generator SMIQB11	2.276
Fig. 2-184	Menu DIGITAL STD - PDC - SAVE/RCL FRAME, SMIQ equipped with Modulation Coder SMIQB20 and Data Generator SMIQB11	2.278
Fig. 2-185	Menu DIGITAL STD - PDC - SELECT SLOT, LINK DIRECTION DOWNLINK, SMIQ equipped with Modulation Coder SMIQB20 and Data Generator SMIQB11	2.279
Fig. 2-186	Menu DIGITAL STD - PDC - SELECT SLOT, LINK DIRECTION = DOWNLINK, SMIQ equipped with Modulation Coder SMIQB20 and Data Generator SMIQB11	2.283
Fig. 2-187	Menu DIGITAL STD - PDC - SELECT SLOT, LINK DIRECTION = DOWNLINK, SMIQ equipped with Modulation Coder SMIQB20 and Data Generator SMIQB11	2.285
Fig. 2-188	Menu DIGITAL STD - PDC - SELECT SLOT, LINK DIRECTION = UPLINK, SMIQ equipped with Modulation Coder SMIQB20 and Data Generator SMIQB11	2.287
Fig. 2-189	Menu DIGITAL STD - GSM/EDGE, SMIQ equipped with Modulation Coder SMIQB20 and Data Generator SMIQB11	2.294
Fig. 2-190	Menu DIGITAL STD - GSM/EDGE - MODULATION..., SMIQ equipped with Modulation Coder SMIQB20 and Data Generator SMIQB11	2.294
Fig. 2-191	Menu DIGITAL STD - GSM/EDGE_TRIGGER..., SMIQ equipped with Modulation Coder SMIQB20 and Data Generator SMIQB11	2.296
Fig. 2-192	Menu DIGITAL STD - GSM/EDGE - CLOCK..., SMIQ equipped with Modulation Coder SMIQB20 and Data Generator SMIQB11	2.297
Fig. 2-193	Menu DIGITAL STD - GSM/EDGE - POWER RAMP CONTROL... , SMIQ equipped with Modulation Coder SMIQB20 and Data Generator SMIQB11	2.298
Fig. 2-194	Menu DIGITAL STD - GSM/EDGE - SAVE/RCL FRAME, SMIQ equipped with Modulation Coder SMIQB20 and Data Generator SMIQB11	2.299
Fig. 2-195	Menu DIGITAL STD - GSM/EDGE - SELECT SLOT - NORM, SMIQ equipped with Modulation Coder SMIQB20 and Data Generator SMIQB11	2.300
Fig. 2-196	Menu DIGITAL STD - GSM/EDGE - SELECT SLOT - DUMMY, SMIQ equipped with Modulation Coder SMIQB20 and Data Generator SMIQB11	2.302

Fig. 2-197	Menu DIGITAL STD - GSM/EDGE - SELECT SLOT – ALL_DATA, SMIQ equipped with Modulation Coder SMIQB20 and Data Generator SMIQB11	2.304
Fig. 2-198	Menu DIGITAL STD - GSM/EDGE - SELECT SLOT – EDGE, SMIQ equipped with Modulation Coder SMIQB20 and Data Generator SMIQB11	2.305
Fig. 2-199	Menu DIGITAL STD - DECT, SMIQ equipped with Modulation Coder SMIQB20 and Data Generator SMIQB11	2.311
Fig. 2-200	Menu DIGITAL STD - DECT - MODULATION... ..	2.311
Fig. 2-201	Menu DIGITAL STD - DECT_TRIGGER..., SMIQ equipped with Modulation Coder SMIQB20 and Data Generator SMIQB11	2.313
Fig. 2-202	Menu DIGITAL STD - DECT - CLOCK..., SMIQ equipped with Modulation Coder SMIQB20 and Data Generator SMIQB11	2.315
Fig. 2-203	Menu DIGITAL STD - DECT - POWER RAMP CONTROL... , SMIQ equipped with Modulation Coder SMIQB20 and Data Generator SMIQB11	2.316
Fig. 2-204	Menu DIGITAL STD - DECT - SAVE/RCL FRAME, SMIQ equipped with Modulation Coder SMIQB20 and Data Generator SMIQB11	2.317
Fig. 2-205	Menu DIGITAL STD - DECT - SELECT SLOT, SMIQ equipped with Modulation Coder SMIQB20 and Data Generator SMIQB11	2.319
Fig. 2-206	Signal flow of ARB generator.....	2.323
Fig. 2-207	Block diagram SMIQB60	2.324
Fig. 2-208	Signal flow SMIQB60.....	2.325
Fig. 2-209	Trigger signals SMIQB60.....	2.326
Fig. 2-210	ARB MOD menu	2.327
Fig. 2-211	ARB MOD - TRIGGER... menu	2.329
Fig. 2-212	ARB MOD - SELECT WAVEFORM... menu	2.331
Fig. 2-213	ARB MOD - WAVEFORM INFO menu.....	2.331
Fig. 2-214	ARB MOD - DELETE WAVEFORM... menu	2.334
Fig. 2-215	ARB MOD - SET SMIQ ACCORDING TO WAVEFORM menu.....	2.334
Fig. 2-216	ARB MOD - CLOCK... menu	2.336
Fig. 2-217	ARB MOD - IQ OUTPUT... menu	2.337
Fig. 2-218	Vector modulation with an external AMIQ	2.338
Fig. 2-219	Menu AMIQ CTRL (presetting depends on AMIQ).....	2.340
Fig. 2-220	Menu AMIQ CTRL -SETUP.....	2.340
Fig. 2-221	Menu AMIQ CTRL -SAVE/RECALL SETTINGS... ..	2.342
Fig. 2-222	Menu AMIQ - SELECT WAVEFORM/EXECUTE BATCH.....	2.343
Fig. 2-223	Menu AMIQ CTRL -LEVEL.....	2.345
Fig. 2-224	Menu AMIQ CTRL - MARKER.....	2.347
Fig. 2-225	Menu AMIQ CTRL – BIT ERROR RATE TEST.....	2.348
Fig. 2-226	BER Measurement	2.350
Fig. 2-227	Operating menu for BER measurement	2.351
Fig. 2-228	PRBS polynomials	2.357
Fig. 2-229	Block diagram of noise generator and distortion simulator.....	2.360
Fig. 2-230	Noise generator and distortion simulator in SMIQ	2.360
Fig. 2-231	Menu NOISE/DIST (presetting)	2.361
Fig. 2-232	Menu NOISE/DIST - POLYNOMIAL.....	2.362
Fig. 2-233	AM/AM conversion.....	2.364
Fig. 2-234	AM/PM conversion.....	2.364
Fig. 2-235	Menu LF OUTPUT (preset setting).....	2.368
Fig. 2-236	Signal example sweep: MODE = AUTO, BLANK TIME = NORMAL	2.372
Fig. 2-237	Signal example sweep: MODE = SINGLE, BLANK TIME = LONG	2.372
Fig. 2-238	Menu SWEEP - FREQ.....	2.373
Fig. 2-239	Menu SWEEP - LEVEL	2.375
Fig. 2-240	Menu SWEEP - LF GEN.....	2.376
Fig. 2-241	Signal example LIST mode: MODE = EXT-STEP	2.380
Fig. 2-242	Menu LIST - OPERATION page.....	2.380
Fig. 2-243	Menu List - EDIT page.....	2.382



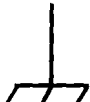



Fig. 2-244	Menu MEM SEQ -OPERATION-page (preset setting)	2.385
Fig. 2-245	Menu MEM SEQ - EDIT page	2.386
Fig. 2-246	Menu UTILITIES -SYSTEM -GPIB	2.387
Fig. 2-247	Menu UTILITIES - SYSTEM - RS232.....	2.388
Fig. 2-248	Menu UTILITIES - SYSTEM - SERDATA.....	2.389
Fig. 2-249	Menu UTILITIES - SYSTEM-SECURITY.....	2.390
Fig. 2-250	Menu UTILITIES - REF OSC (preset setting).....	2.391
Fig. 2-251	Menu UTILITIES - PHASE (preset setting).....	2.392
Fig. 2-252	Menu UTILITIES - PROTECT (preset setting)	2.393
Fig. 2-253	Menu UTILITIES - CALIB - ALL.....	2.394
Fig. 2-254	Menu UTILITIES - CALIB - VCO SUM	2.395
Fig. 2-255	Menu UTILITIES - CALIB - VECTOR MOD menu.....	2.396
Fig. 2-256	Menu UTILITIES - CALIB - LEV PRESET	2.397
Fig. 2-257	Menu UTILITIES - CALIB - ALC TABLE.....	2.398
Fig. 2-258	Menu UTILITIES - CALIB - LEV ATT.....	2.399
Fig. 2-259	Menu UTILITIES - CALIB – LFGEN	2.400
Fig. 2-260	Menu UTILITIES - DIAG - CONFIG.....	2.401
Fig. 2-261	Menu UTILITIES - DIAG - TPOINT	2.402
Fig. 2-262	Menu UTILITIES - DIAG - C/N MEAS	2.403
Fig. 2-263	Menu UTILITIES - DIAG - PARAM.....	2.404
Fig. 2-264	Menu UTILITIES - MOD KEY (preset setting)	2.405
Fig. 2-265	Menu UTILITIES - AUX I/O.....	2.406
Fig. 2-266	Menu UTILITIES - BEEPER	2.407
Fig. 2-267	Menu UTILITIES - INSTALL, fitted with options	2.408
Fig. 2-268	Menu STATUS page.....	2.409
Fig. 2-269	ERROR page.....	2.410
Fig. 3-1	Tree structure of the SCPI command systems using the SOURce system by way of example	3.6
Fig. 3-2	Instrument model in the case of remote control by means of the IEC bus.....	3.205
Fig. 3-3	The status -register model.....	3.208
Fig. 3-4	Overview of the status register	3.210
Fig. 4-1	UTILITIES-TEST menu	4.2
Fig. A-1	Contact Assignment of the IEC-bus socket.....	A.1
Fig. A-2	Pin assignment of RS-232-C connector	A.4
Fig. A-3	Wiring of data, control and signalling lines for hardware handshake	A.6

Safety Instructions

This unit has been designed and tested in accordance with the EC Certificate of Conformity and has left the manufacturer's plant in a condition fully complying with safety standards.

To maintain this condition and to ensure safe operation, the user must observe all instructions and warnings given in this operating manual.

Safety-related symbols used on equipment and documentation from R&S:

							
Observe operating instructions	Weight indication for units >18 kg	PE terminal	Ground terminal	Danger! Shock hazard	Warning! Hot surfaces	Ground	Attention! Electrostatic sensitive devices require special care

1. The unit may be used only in the operating conditions and positions specified by the manufacturer. Unless otherwise agreed, the following applies to R&S products:
IP degree of protection 2X, Pollution severity 2, overvoltage category 2, altitude max. 2000 m.
The unit may be operated only from supply networks fused with max. 16 A.
2. For measurements in circuits with voltages $V_{rms} > 30 V$, suitable measures should be taken to avoid any hazards.
(using, for example, appropriate measuring equipment, fusing, current limiting, electrical separation, insulation).
3. If the unit is to be permanently wired, the PE terminal of the unit must first be connected to the PE conductor on site before any other connections are made. Installation and cabling of the unit to be performed only by qualified technical personnel.
4. For permanently installed units without built-in fuses, circuit breakers or similar protective devices, the supply circuit must be fused such as to provide suitable protection for the users and equipment.
5. Prior to switching on the unit, it must be ensured that the nominal voltage set on the unit matches the nominal voltage of the AC supply network.
If a different voltage is to be set, the power fuse of the unit may have to be changed accordingly.
6. Units of protection class I with disconnectible AC supply cable and appliance connector may be operated only from a power socket with earthing contact and with the PE conductor connected.
7. It is not permissible to interrupt the PE conductor intentionally, neither in the incoming cable nor on the unit itself as this may cause the unit to become electrically hazardous.
Any extension lines or multiple socket outlets used must be checked for compliance with relevant safety standards at regular intervals.
8. If the unit has no power switch for disconnection from the AC supply, the plug of the connecting cable is regarded as the disconnecting device. In such cases it must be ensured that the power plug is easily reachable and accessible at all times (length of connecting cable approx. 2 m). Functional or electronic switches are not suitable for providing disconnection from the AC supply.
If units without power switches are integrated in racks or systems, a disconnecting device must be provided at system level.
9. Applicable local or national safety regulations and rules for the prevention of accidents must be observed in all work performed.
Prior to performing any work on the unit or opening the unit, the latter must be disconnected from the supply network.
Any adjustments, replacements of parts, maintenance or repair may be carried out only by authorized R&S technical personnel.
Only original parts may be used for replacing parts relevant to safety (eg power switches, power transformers, fuses). A safety test must be performed after each replacement of parts relevant to safety.
(visual inspection, PE conductor test, insulation-resistance, leakage-current measurement, functional test).

continued overleaf

Safety Instructions

10. Ensure that the connections with information technology equipment comply with IEC950 / EN60950.
11. Lithium batteries must not be exposed to high temperatures or fire.
Keep batteries away from children.
If the battery is replaced improperly, there is danger of explosion. Only replace the battery by R&S type (see spare part list).
Lithium batteries are suitable for environmentally-friendly disposal or specialized recycling. Dispose them into appropriate containers, only.
Do not short-circuit the battery.
12. Equipment returned or sent in for repair must be packed in the original packing or in packing with electrostatic and mechanical protection.
13. Electrostatics via the connectors may damage the equipment. For the safe handling and operation of the equipment, appropriate measures against electrostatics should be implemented.
14. Any additional safety instructions given in this manual are also to be observed.



Certificate No.: 2002-23

This is to certify that:

Equipment type	Stock No.	Designation
SMIQ06ATE	1125.5555.26	Vector Signal Generator

complies with the provisions of the Directive of the Council of the European Union on the approximation of the laws of the Member States

- relating to electrical equipment for use within defined voltage limits (73/23/EEC revised by 93/68/EEC)
- relating to electromagnetic compatibility (89/336/EEC revised by 91/263/EEC, 92/31/EEC, 93/68/EEC)

Conformity is proven by compliance with the following standards:

EN61010-1 : 1993 + A2 : 1995
EN50081-1 : 1992
EN61000-6-2 : 1999

Affixing the EC conformity mark as from 2002

ROHDE & SCHWARZ GmbH & Co. KG
Mühldorfstr. 15, D-81671 München

Munich, 2002-05-07

Central Quality Management FS-QZ / Becker



Certificate No.: 2002-09

This is to certify that:

Equipment type	Stock No.	Designation
SMIQ03HD	1125.5555.33	Vector Signal Generator

complies with the provisions of the Directive of the Council of the European Union on the approximation of the laws of the Member States

- relating to electrical equipment for use within defined voltage limits
(73/23/EEC revised by 93/68/EEC)
- relating to electromagnetic compatibility
(89/336/EEC revised by 91/263/EEC, 92/31/EEC, 93/68/EEC)

Conformity is proven by compliance with the following standards:

EN61010-1 : 1993 + A2 : 1995
EN55011 : 1998 + A1 : 1999, Klasse B
EN61326-1 : 1997 + A1 : 1998

For the assessment of electromagnetic compatibility, the limits of radio interference for Class B equipment as well as the immunity to interference for operation in industry have been used as a basis.

Affixing the EC conformity mark as from 2002

ROHDE & SCHWARZ GmbH & Co. KG
Mühlendorfstr. 15, D-81671 München

Munich, 2002-02-28

Central Quality Management FS-QZ / Becker



Certificate No.: 99015

This is to certify that:

Equipment type	Order No.	Designation
SMIQ02B	1125.5555.02	Vector Signal Generator
SMIQ03B	1125.5555.03	
SMIQ04B	1125.5555.04	
SMIQ06B	1125.5555.06	
SMIQB10	1085.5009.02	Modulation Coder
SMIQB11	1085.4502.02/.04	Data Generator
SMIQB12	1085.2800.02/.04	Memory Extension
SMIQB14	1085.4002.02	Fading Simulator
SMIQB15	1085.4402.02	Second Fading Simulator
SMIQB17	1104.9000.02	Noise Generator
SMIQB20	1125.5190.02	Modulation Coder
SMIQB21	1125.5490.02	BER Measurement
SMIQB46	1105.0006.02	Low ACP
SMIQB47	1125.5090.02	Low ACP
SMIQB60	1136.4390.02	Arbitrary Waveform Generator

complies with the provisions of the Directive of the Council of the European Union on the approximation of the laws of the Member States

- relating to electrical equipment for use within defined voltage limits
(73/23/EEC revised by 93/68/EEC)
- relating to electromagnetic compatibility
(89/336/EEC revised by 91/263/EEC, 92/31/EEC, 93/68/EEC)

Conformity is proven by compliance with the following standards:

EN61010-1 : 1993 + A2 : 1995
EN50081-1 : 1992
EN50082-2 : 1995

Affixing the EC conformity mark as from 1999

ROHDE & SCHWARZ GmbH & Co. KG
Mühldorfstr. 15, D-81671 München

Munich, 2000-04-06

Central Quality Management FS-QZ / Becker

1 Preparation for Use

1.1 Putting into Operation

Before putting the SMIQ into operation, please make sure that

- the covers of the casing are put on and screwed,
- the ventilation openings are free,
- no signal voltage levels exceeding the permissible limits are applied at the inputs,
- the outputs of the instrument are not overloaded or connected incorrectly.

If these points are not observed, the instrument might be damaged.

1.1.1 Supply Voltage

The SMIQ can be operated at a.c. systems from 90 V to 132 V and 180 V to 265 V at system frequencies from 47 Hz to 440 Hz. The power supply socket is situated at the rear of the instrument. The instrument automatically sets itself to the voltage applied within the permissible voltage ranges. It is not necessary to set the instrument to a certain supply voltage.

1.1.2 Switching On/Off the Instrument

Power switch at the rear of the instrument

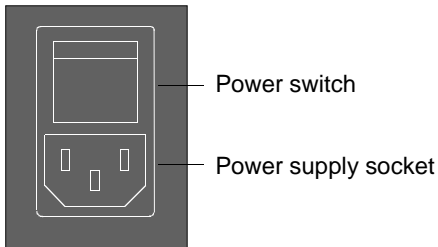

Switch on/off: ➤ Press power switch at the top (I) / bottom (O)

The power switch can remain switched on permanently. Switching off is only necessary when the instrument is to be completely disconnected from the mains.

On/off switch at the front of the instrument

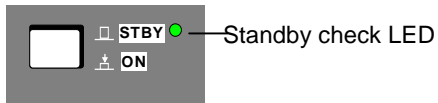

Switch on: ➤ Press switch.
The instrument is ready for operation.

Switch off: ➤ Release switch.
The instrument assumes the STANDBY mode.

1.1.3 Initial Status

Upon switching on, the instrument either automatically assumes the status which was set when it was switched off (parameter POWER-ON STATE PREVIOUS SETTING in LEVEL-LEVEL menu) or the RF output is disconnected (POWER-ON STATE RF OFF).

If the instrument need not to be operated from the initial status any further, a defined default status should be established by pressing the [PRESET] key prior to further settings.

STANDBY Mode

In the STANDBY mode the optional reference oscillator (option SM-B1) remains switched on, which increases frequency accuracy.

Frequency accuracy after switching on when the oven-controlled reference oscillator is fitted (option SM-B1)

When switching on from the STANDBY mode, the specified frequency accuracy is reached immediately. If the power switch was switched off, the reference oscillator needs some minutes of warm-up time to reach its nominal frequency. During this period of time, the output frequency does not yet reach its final value either. In the status line in the header field of the display the message "OVEN COLD" is displayed for this time.

1.1.4 Setting Contrast and Brightness of the Display

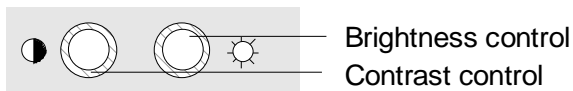

Contrast and brightness of the display can be set by means of the contrast and brightness controls situated below the display.

1.1.5 RAM with Battery Back-Up

The SMIQ has a static read-write memory (CMOS-RAM) with battery back-up, in which 50 different complete settings of the instrument can be stored (cf. Chapter 2, section "Storing and Calling of Instrument Settings"). In addition, all data and/or lists the user enters himself, such as for list mode, memory sequence, and user correction of the level, are stored in the RAM. Further, all data of the calibrations running within the instrument in the SMIQ are stored in the RAM (cf. Chapter 2, section "Calibration").

A lithium battery with a service life of approx. 5 years serves to supply the RAM with power. When the battery is discharged, the data stored will be lost. For exchange of the battery see Service Manual.

1.1.6 Preset Setting

A defined setting status is achieved by pressing the [PRESET] key.

Preset Status:

RF frequency	100 MHz
RF level	-30 dBm
Reference frequency	internal, adjustment off
Offsets	0
Modulations	switched off
Transient-free level setting	switched off, level attenuator mode: AUTO
Internal level control	level ALC: AUTO
User correction	level UCOR: OFF
LF output	switched off
Sweep	switched off
List mode	switched off
Memory sequence	switched off
Suppression of indications	system security: unaltered
Protection of calibration data	protection lock: unaltered
Settings stored	unaltered
Data, lists etc. stored	unaltered
IEC-bus address	unaltered
Beeper	unaltered

All parameters and circuit states, even those of operating modes which are not activated, are preset by means of Preset.

The presettings going beyond the above list can be seen from the menu representations as of Section 2.4 which each indicate the Preset setting status.

1.2 Functional Test

On switching on the instrument and permanently during operation, the SMIQ carries out a self test. The ROM contents as well as the battery of the non-volatile RAM are checked on switching on the instrument and the RAM contents with every calling the memory. The most important instrument functions are automatically monitored during operation.

If an error is detected, the message "ERROR" is displayed in the status line. For further identification of the error, press the [ERROR] key. Thereupon a description of the error/s is displayed (cf. Chapter 2, section "Error Messages"). Return to the menu exited by pressing the [RETURN] key.

If required, the self tests can be induced purposefully. See Chapter 4, section "Functional Test". Further, internal test points can be polled by the user and the results be read out and displayed. See Chapter 2, section "Voltage Indication of Test Points".

1.3 Fitting the Options

Due to its variety of options, the SMIQ offers the possibility of providing the instrument with the equipment exactly corresponding to the application. Newly fitted options are automatically recognized and the relevant parameters added in the menu.

After every change of the instrument configuration, the CMOS RAM has to be cleared as the storage data shift:

- Switch off the instrument
- Switch the instrument on again with the [RESET] key pressed

The internal calibration routines VECTOR MOD, VCO SUM, and LEV PRESET now have to be called up again to restore the cleared calibration values.

These routines are accessible via menu UTILITIES-CALIB (see also Chapter 2, section "calibration"). The calibration routines have to be carried out in the following order:

1. VCO SUM (Summing loop)
2. VECTOR MOD
3. LEV PRESET

1.3.1 Opening the Casing



Caution:

Prior to opening the SMIQ, unplug the power connector.

Remove paneling

- Remove four screws in the two tilt feet at the rear of the instrument.
- Remove the upper paneling towards the top and rear.
- Turn the instrument.
- Remove the lower paneling towards the top and rear.

Open ventilation ducts

When an option is fitted at a slot which has not been used up to now, the appropriate ventilation duct of the plexiglas plate at the left in the casing frame must be opened. The openings are pre-punched so that the respective part is easy to break out.

1.3.2 Overview of the Slots

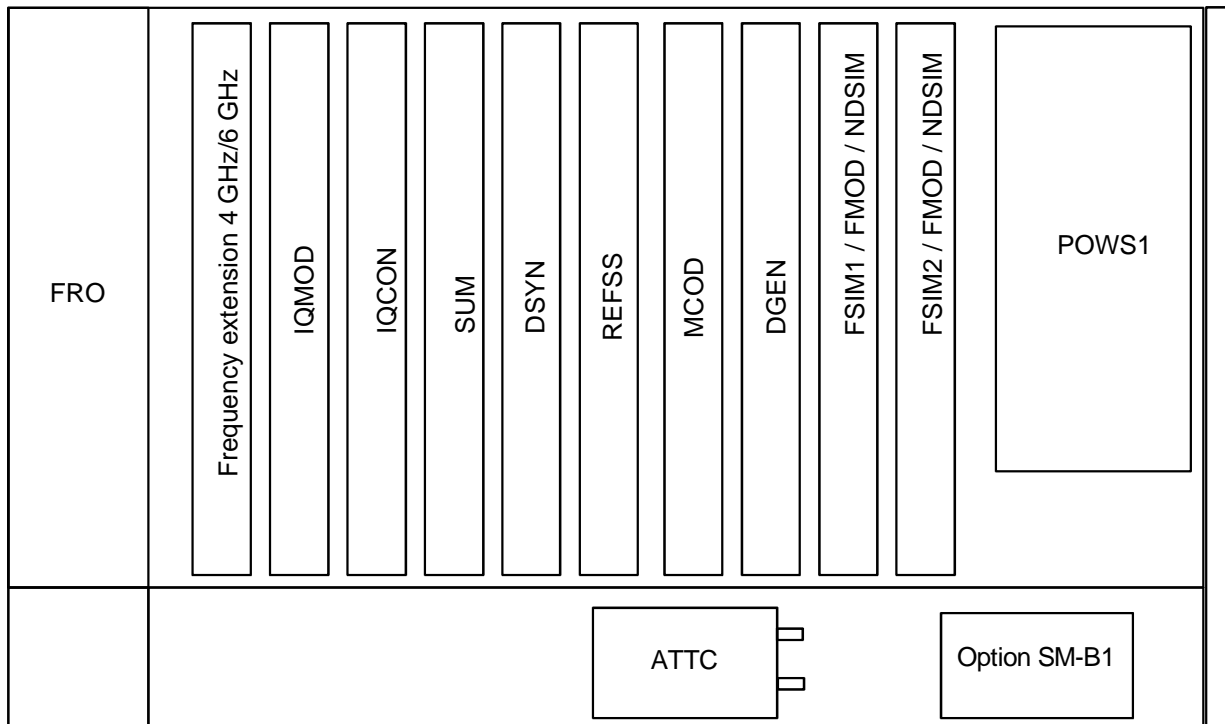

FRO = front unit	MCOD = modulation coder
FMOD = FM/PM modulator	DGEN = data generator
IQMOD = I/Q modulator	FSIM = fading simulator
IQCON = I/Q converter	POWS1 = power supply
SUM = summing loop	ATTC = attenuator
DSYN = digital synthesis	NDSIM = Noise generator and
REFSS = reference/step synthesis	distortion simulator

Fig. 1-1 SMIQ, view from the top

1.3.3 Option SM-B1 - Reference Oscillator OCXO

Fitting the option

- Fasten the option at the back end of the lateral opening by means of the screw threads provided there.
- If the two last slots are both occupied, one of these modules must be removed temporarily.
- Feed ribbon cable W710 through the rear square cut-out to the motherboard, insert into connector X22 and snap in the locking.
- Feed coaxial cable W170 from socket X711 of the option through the second cut-out along the rear transverse panel to connector X74 at the A7 module, reference/step synthesis, via the motherboard and insert there.

Set tuning voltage and calibrate OCXO

The crystal oscillator was factory-tuned to nominal frequency and the appropriate tuning voltage indicated on the cover of the module. The calibration value now has to be calculated from this value and transferred to the memory of the signal generator.

Calculate calibration value

The tuning voltage is generated by a 12b-bit-D/A converter which is scaled such that a tuning voltage of 12 volts is generated with calibration value (CALIBRATION DATA) 4000.

The calibration value is thus calculated from the tuning voltage (V_{tun}) as follows

$$\text{CALIBRATION DATA} = V_{\text{tun}} \times 4000 / 12$$

For checking purposes, the voltage at pin 16 of plug X22 on the motherboard can be remeasured and corrected if necessary. A check by means of frequency measurement may only be made after a warm-up of 2 hours and against a calibrated reference.

Store calibration value

- Unlock protection level 2 with code 250751.
- v Call menu UTILITIES-CALIB-REF OSC.
- Enter the calculated calibration voltage with CALIBRATION DATA by means of the rotary knob or keypad.
- Select STORE CALIBRATION DATA
- Terminate entry using the [SELECT] key
The new calibration value is stored in the EPROM.

Note: *The flash EPROM does not permit the deletion of individual data. Thus new memory space is occupied for each calibration. If there is no memory space available any more, the EPROM must be cleared by an authorized service shop and be written into anew. Thus a calibration should only be made if necessary*

1.3.4 Option SM-B5 - FM/PM Modulator

The FM/PM modulator is fitted at the slot with label 'FMOD'.

Fitting the option

- Withdraw cable W89 from X99 of the summing loop and use again.
- Establish the following connections:

Cable	From	To	Signal
W89	A8-X89	A6-X67	FDSYN
W65	A6-X65	A7-X71	REF100
W67	A6-X69	A9-X99	FDFM

1.3.5 Option SMIQB11 - Data Generator

The Data Generator is fitted at the slot with label "DGEN".

- Plug the module into the slot.
- Lock it and fasten all screws.
- Plug W341 onto X341.
- Open the air inlets at the housing frame by breaking out the safety glass plate which belongs to the option.

1.3.6 Option SMIQB12 - Memory Extension to Data Generator

The Data Generator can be upgraded with up to two memory extension units (SMIQB12). The first Memory Extension is fitted at the slot with label "X350", the second Memory Extension at slot with label "X351".

- Remove option Data Generator from SMIQ.
- Withdraw the screws of the labelled screening cover and remove the cover.
- The first memory extension unit has to be plugged on connector X350 near the battery.
- The second memory extension unit has to be plugged on connector X351.
- Refit the screening cover of the Data Generator module.
- Plug the Data Generator back into the appropriate place, lock it and fasten all screws.

1.3.7 Option SMIQB14 - Fading Simulator FSIM1

The Fading Simulator is fitted at the slot with label 'FSIM1'.

Before fitting the option SMIQB14 (FSIM1) first check the correct settings of the jumpers on the module. For FSIM modules of series 1085.XXXX (see screening cover) the jumper setting also depends on the number of fading simulators installed, either one (FSIM1) or two (FSIM1 and FSIM2).

After an instrument warm-up period of 2 hours, the IQ Modulator should be calibrated.

Two coaxial connecting cables (Stock No. 1085.4448.00) are part of the equipment supplied with the option. The cables can be connected to the outputs I FADED and Q FADED at the rear of SMIQ.

Checking the jumper settings

Jumper Setting for the Fading Simulator FSIM1:
(Cf. labeling 'Jumper Setting' and labeling on the screening cover of the module)

FSIM1	One Fading Simulator installed FADING SIMULATOR: 1085.XXXX			Two Fading Simulators installed FADING SIMULATOR: 1085.XXXX			FADING SIMULATOR: 1114.XXXX		
	Jumper connects								
	X1.1	with	X1.2	X1.1	with	X1.2	X1.2	with	X1.3
	X8.1	with	X8.2	X8.2	with	X8.3	X8.1	with	X8.2
	X9.1	with	X9.2	X9.2	with	X9.3	X9.2	with	X9.3
	X12.2	with	X12.3	X12.2	with	X12.3	X12.2	with	X12.3
	X13.1	with	X13.2	X13.2	with	X13.3	X13.1	with	X13.2
	X15.1	with	X15.2	X15.1	with	X15.2	X15.1	with	X15.2
	X16.1	with	X16.2	X16.2	with	X16.3	none		

Fading modules of series 1114.XXXX also require the setting of a DIP switch. The setting is indicated on the screening cover.

	FADING SIMULATOR 1114.XXXX	
Switch	1	2
FSIM1	OFF	ON

Fitting the option

- Plug the module into the appropriate slot, lock it and fasten all screws.
- Open the air inlets at the housing frame by breaking out the safety glass plate which belongs to the option.
- Depending on the fact whether the option SMIQB20 (MCOD) has been installed in the SMIQ, the following coaxial connections have to be made:

Note: Please store the remaining cables. They will be required if further options will be installed at a later stage or options will be removed.

		SMIQ with option MCODE	SMIQ without option MCODE	Remark about cable
Cable	from FSIM1	to	to	
W361	X361	MCOD X325	-	W361 was provided with FSIM1
W244	X361	-	FRO I socket	Withdraw W244 from X244 of module IQMOD
W363	X363	MCOD X328	-	W363 was provided with FSIM1
W245	X363	-	FRO Q socket	Withdraw W245 from X245 of module IQMOD
W367	X367	IQMOD X244	IQMOD X244	W367 was provided with FSIM1
W388	X368	REAR I FADED	REAR I FADED	W388 was provided with FSIM1
W370	X370	IQMOD X245	IQMOD X245	W370 was provided with FSIM1
W391	X371	REAR Q FADED	REAR Q FADED	W391 was provided with FSIM1

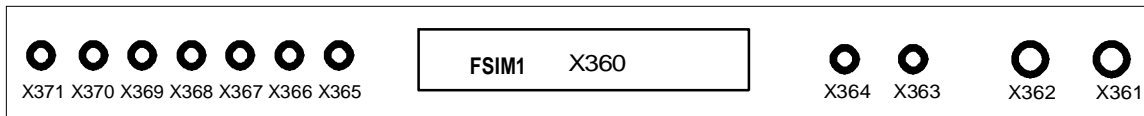

Fig. 1-2 Module FSIM

- The included adhesive label 'Option included' is to be fixed at the rear panel of the SMIQ.

Calibrating the Fading Simulator and the I/Q Modulator

- Warm-up the instrument for 2 hours.
- Call up menu UTILITIES - CALIB - VECTOR MOD.

1.3.8 Option SMIQB15 - Second Fading Simulator (FSIM2)

The second Fading Simulator is fitted at the slot with label 'FSIM2'.

Before fitting the option SMIQB15 (FSIM2) please check the correct settings of the jumpers on both fading modules FSIM1 (see Section 1.3.7) and FSIM2. The jumper settings depend on the series of the FSIM module, they are also indicated on the screening cover.

After an instrument warm-up period of 2 hours, the IQ Modulator should be calibrated.

Checking the jumper settings

Jumper Setting for the Fading Simulator FSIM2:
(cf. module number and labeling 'Jumper Setting' on the screening cover of the module)

FSIM2	FADING SIMULATOR 1085.XXXX			FADING SIMULATOR 1114.XXXX			
	Jumper connects	X1.2	with	X1.3	X1.1	with	X1.2
		X8.2	with	X8.3	X8.2	with	X8.3
		X9.2	with	X9.3	X9.1	with	X9.2
		X12.1	with	X12.2	X12.1	with	X12.2
		X13.2	with	X13.3	X13.2	with	X13.3
		X15.2	with	X15.3	X15.2	with	X15.3
		X16.2	with	X16.3	none		

Fading modules of series 1114.XXXX also require the setting of a DIP switch. The setting is indicated on the screening cover.

Switch	FADING SIMULATOR 1114.XXXX	
	1	2
FSIM1	OFF	ON
FSIM2	ON	OFF

Fitting the option

- Plug the module into the appropriate slot for the FSIM2, lock it and fasten all screws.
- Open the air inlets at the housing frame by breaking out the safety glass plate which belongs to the option.
- The following coaxial connections have to be made:

	FSIM2 Module number 1085.XXXX	FSIM2 Module number 1114.XXXX	FSIM1
Cable	from	from	to
W362	X361	X362	X362
W364	X363	X364	X364
W365	X365	X365	X365
W366	X367	X368	X366
W369	X370	X371	X369

Note: Please store the remaining cables. They will be required if further options will be installed at a later stage or options will be removed.

- The included adhesive label 'Option included' is to be fixed at the rear panel of the SMIQ.

Calibrating the Fading Simulator and the I/Q Modulators

- Warm-up the instrument for 2 hours.
- Call up menu UTILITIES - CALIB - VECTOR MOD.

Retrofit for 2-channel fading

Cables W388 and W391 have to be repositioned for 2-channel fading.

- Unplug W388 from X368 of FSIM1 and plug to X368 (1085.XXXX) or X367 (1114.XXXX) of FSIM2.
- Unplug W391 from X371 of FSIM1 and plug to X371 (1085.XXXX) or X370 (1114.XXXX) of FSIM2.

1.3.9 Option SMIQB17 - Noise Generator and Distortion Simulator

Depending on which options are fitted, the NDSIM module is mounted in the slot labelled FSIM1/FMOD/NDSIM or FSIM2/FMOD/NDSIM or E6GHZ/FMOD/NDSIM (in older units slot FSIM1/FMOD or FSIM2/FMOD).

After an instrument warm-up period of 1 hour, the NDSIM as well as the IQ Modulator should be calibrated. Then the instrument is ready for use.

Six coaxial connecting cables (W601, W602, W603, W388, W605, W391 and the adhesive option label are part of the equipment supplied with the option.

Fitting the option

- Plug the module into the appropriate slot.
- Lock it and fasten all screws.
- Open the air inlets at the housing frame by breaking out the safety glass plate which belongs to the option.
- If options FSIM1 and FSIM2 are fitted, cables W388 and W391 have to be connected as shown in Fig. 1-3.
- Depending on which modules are installed in the SMIQ, the following coaxial connections are to be made:

		SMIQ without option MCOD without option FSIM1 without option FSIM2		SMIQ with option MCOD without option FSIM1 without option FSIM2		Remark about cable
Cable	from NDSIM	to		to		
W244	X601	FRO	I-connector	-		Cable was provided with unit
W245	X602	FRO	Q-connector	-		Cable was provided with unit
W601	X601		-	MCOD	X325	W601 was provided with NDSIM
W602	X602		-	MCOD	X328	W602 was provided with NDSIM
W603	X603	IQMOD	X244	IQMOD	X244	W603 was provided with NDSIM
W388	X604	REAR	I FADED	REAR	I FADED	W388 was provided with NDSIM
W605	X605	IQMOD	X245	IQMOD	X245	W605 was provided with NDSIM
W391	X606	REAR	Q FADED	REAR	Q FADED	W391 was provided with NDSIM

		SMIQ with option MCOD with option FSIM1 without option FSIM2		SMIQ with option MCOD with option FSIM1 with option FSIM2		Remark about cable
Cabel	from NDSIM	to		to		
W601	X601	FSIM1	X367	FSIM1	X367	W601 was provided with NDSIM
W602	X602	FSIM1	X370	FSIM1	X370	W602 was provided with NDSIM
W603	X603	IQMOD	X244	IQMOD	X244	W603 was provided with NDSIM
W388	X604	REAR	I FADED	REAR	I FADED	W388 was provided with NDSIM
W605	X605	IQMOD	X245	IQMOD	X245	W605 was provided with NDSIM
W391	X606	REAR	Q FADED	REAR	Q FADED	W391 was provided with NDSIM

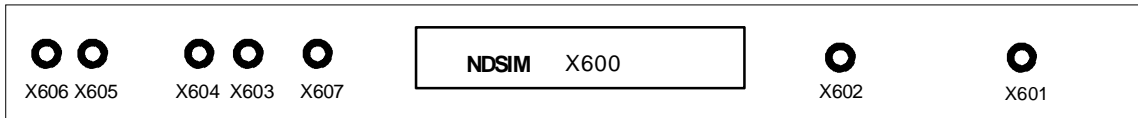

Fig. 1-3 Module NDSIM

Connector X607 is unused and provided only in some modules.

- The included adhesive label 'Option included' is to be fixed at the rear panel of the SMIQ.

Calibrating the NDSIM and the I/Q Modulator

- Warm-up the instrument for 1 hours.
- Call up menu UTILITIES - CALIB - VECTOR MOD.

1.3.10 Option SMIQB20 - Modulation Coder

The Modulation Coder is fitted at the slot with label "MCOD".

- Plug the module into the appropriate place, lock it and fasten all screws.
- Open the air inlets at the housing frame by breaking out the safety glass plate which belongs to the option
- Depending on the fact whether the option SMIQB14 (FSIM1) has been installed in the SMIQ, the following coaxial connections have to be made (cf. Fig. 1-4):

Note: Please store the remaining cables. They will be required if further options will be installed at a later stage or options will be removed.

		SMIQ without option FSIM 1	SMIQ with option FSIM 1	Remark about cable
Cable	from MCODE	to	to	
W322	X321	REFSS X72	REFSS X72	W322 was provided with MCODE.
W72	X322	DSYN X81	DSYN X81	Withdraw W72 from X72 of module REFSS.
W243	X323	BACK POW RAMP socket	BACK POW RAMP socket	Withdraw W243 from X243 of module IQMOD.
W324	X324	IQMOD X243	IQMOD X243	W324 was provided with MCODE.
W325	X325	IQMOD X244	-	W325 was provided with MCODE.
W361	X325	-	FSIM 1 X361	W361 was provided with FSIM1.
	X326	-	-	-
W244	X327	FRO I socket	FRO I socket	Withdraw W244 from X244 of module IQMOD. If FSIM1 is installed withdraw W244 from X361 of module FSIM1.
W328	X328	IQMOD X245	-	W328 was provided with MCODE.
W363	X328	-	FSIM 1 X363	W363 was provided with FSIM1.
	X329	-	-	-
W245	X330	FRO Q socket	FRO Q socket	Withdraw W245 from X245 of module IQMOD. If FSIM1 is installed withdraw W245 from X363 of module FSIM1.

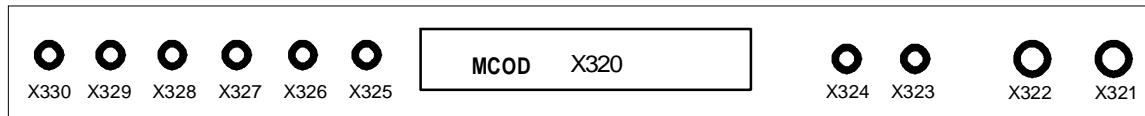

Fig. 1-4 Module MCODE

- The included adhesive label "Option included" is to be fixed at the rear panel of the SMIQ.

1.3.11 Option SMIQB21 - Bit Error Rate Test

Software option SMIQB21 has to be enabled by entering a key upon installation. An option label containing the installation key is supplied and has to be affixed to the rear of SMIQ for service and repair purposes.

As a prerequisite, SMIQ must be fitted with hardware option SMIQB20 (modulation coder).

Enabling the option

- Switch on SMIQ.
- Call UTILITIES menu (select with rotary knob, confirm with [SELECT] key).
- Call INSTALL menu ==> [SELECT].
- Call OPTION TO INSTALL menu ==> [SELECT].
- Select option SMIQB21 BERT ==> [SELECT].
- Enter the 6-digit installation key shown on the option label into the INSTALLATION KEY line. Then press the [ENTER] key.
- You will receive a message confirming that the installation key has been verified and the option is installed.
- To make the option available, the unit has to be switched off and on again.
- Once the installation has been successfully completed, BER measurement can be selected from the main menu.

Once the installation has been completed, the availability of the new option can be checked in the module list in the UTILITIES DIAG CONFIG menu.

Connector

The clock and data signals output by the DUT must have TTL level and are connected to the BER (bit error rate) input, a 9-contact SUB-D connector at the rear of the unit labelled BER. Pin assignment is as follows:

	SUB-D connector	Adapter cable Order No. 1110.3551.00
1,2,3,4,5	Ground	Screen
6	Bit clock input	CLOCK
7	Data input	DATA
8	Data enable input	DAT ENAB
9	Restart	RES

Polarity of clock and data signals, the PRBS polynomial used and the integration time can be set by manual or remote-control commands. The input signals are **not** terminated in the SMIQ but applied to ICs of type 74LVT14 via a 220 Ω resistor. A cable is supplied with the option. Its contacts are assigned to BNC connectors as shown in the above table.

1.3.12 Other Software Options

SMIQB42 / SMIQB43 / SMIQB45 / SMIQB47 / SMIQB48 / SMIQB49 / SMIQB60 / SMIQK11 / SMIQK12

You have acquired a software option to go with your Signal Generator SMIQ from Rohde & Schwarz. This option must be enabled by an installation keyword. Please affix the enclosed option label including the installation keyword to the rear panel of the SMIQ since it is required for service and repair. For installation of software option SMIQB21 cf. section 1.3.11.

Enclosed option label with a typical keyword:

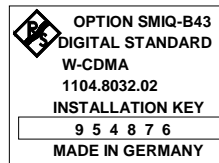

<== Example

For a successful installation the necessary hardware options as well as the firmware version are listed in the following table. The firmware version is indicated in the right part of the display when only the main menu appears. If your instrument is equipped with an older version, update the firmware first. Disks, cables and update instructions are provided with the package.

Option	Necessary hardware/software options	Firmware version (at least)	Remark
SMIQB42	SMIQB10 (MCOD) and SMIQB11 (DGEN)	3.20	
	SMIQB20 (MCOD2) and SMIQB11 (DGEN)	5.10 HX	
SMIQB43	SMIQB10 (MCOD) and SMIQB11 (DGEN)	3.80	
	SMIQB20 (MCOD2) and SMIQB11 (DGEN)	5.10 HX	
SMIQB45	SMIQB20 (MCOD2) and SMIQB11 (DGEN)	5.10 HX	
SMIQB47	IQ modulator (IQMOD) variant 8	3.91	
SMIQB48	SMIQB20 (MCOD2), SMIQB11 (DGEN) and SMIQB45	5.30 HX	
SMIQB49	SMIQB14 and/or SMIQB15 (FSIM)	5.40 HX	
SMIQB60	SMIQB20 (MCOD2) and SMIQB11 (DGEN)	5.20 HX	PC software WinIQSIM recommended
SMIQK11	SMIQB60	5.20 HX	PC software WinIQSIM recommended
SMIQK12	SMIQB60	5.20 HX	

- Enabling option:
- Switch on SMIQ.
 - Call up menu UTILITIES. (Select it by means of the rollkey, confirm with [SELECT] key).
 - Call up menu INSTALL ==> [SELECT]
 - Call up menu OPTION TO INSTALL ==> [SELECT]
 - Select the option you want to install ==> [SELECT]
 - Read the 5 or 6-digit keyword on the option label and enter it into the corresponding field in the INSTALLATION KEY line. Then press the [ENTER] key.
 - A message will then be issued to the effect that the keyword has been checked and that the option is being installed.
 - For the option to be available the unit has to be switched off and then on again.

After installation, the new option is listed in the module list of the UTILITIES-DIAG-CONFIG menu. In case of any problems contact your Rohde&Schwarz service center.

1.3.13 Option SMIQB19 - Rear Panel Connections for RF and LF

The SMIQ can be retrofitted to include rear panel connections for RF and LF for mounting it into a 19" rack using option SMIQB19. The mounting instructions are attached to the option.

1.4 Mounting into a 19" Rack

Caution: *Ensure free air inlet at the perforation of the side walls and air outlet at the rear of the instrument in rack mounting.*

The SMIQ can be mounted into a 19" rack by means of rack adapter ZZA-94 (stock no. 396.4905.00). The mounting instructions are attached to the adapter.

2 Operation

2.1 Front and Rear Panel

2.1.1 Display

(cf. Fig. 2-1, Front panel view)

1

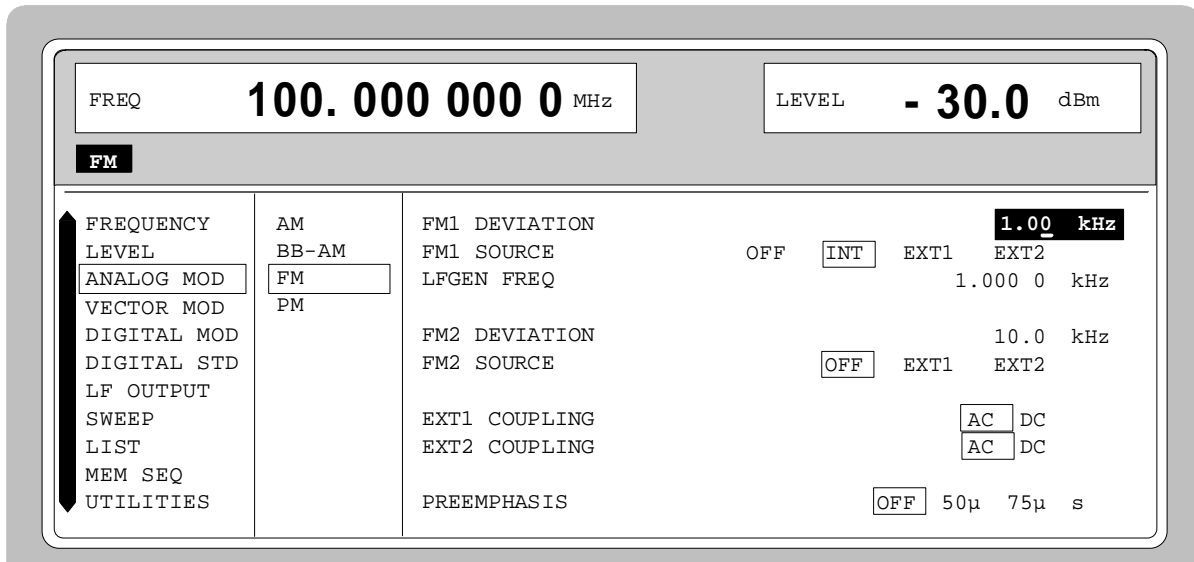

The display shows in the

- header field:
- the current frequency and level settings (considering an offset).
 - status messages.
 - error messages.

- menu field:
- the main menu and the submenus selected with the current settings.

Parameters can be selected and changed in the menus indicated.

see as well
Chapter 2,
Section "Design of the
Display"

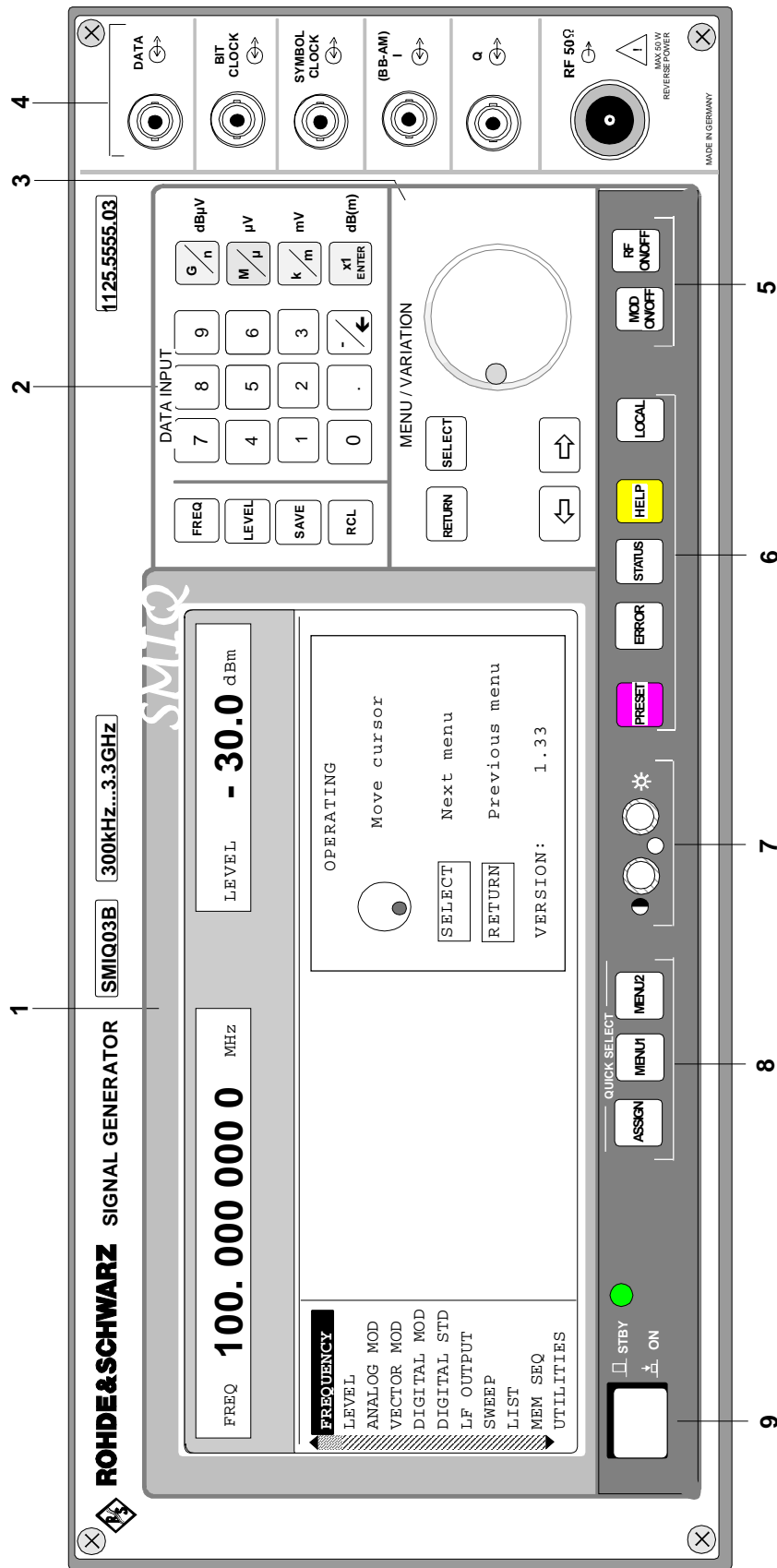

Fig. 2-1 Front panel view

2.1.2 Controls and Inputs/Outputs of the Front Panel

(cf. Fig. 2-1, front panel view)

2 DATA INPUT

Parameter field



Parameters RF frequency and RF level can be entered directly by means of the parameter keys, alternatively to menu operation. The input value (indicated in the header field) considers the offset, see Sections 2.4 and 2.5. Further, complete instrument settings can be stored and called.

- FREQ** Opens the setting of the RF frequency via value input or variation by means of a rotary knob. The current menu is maintained. Return to the menu by means of the [RETURN] key. (Setting of the RF frequency also in the FREQUENCY menu).
- LEVEL** Opens the setting of the RF level via value input or variation by means of a rotary knob. The current menu is maintained. Return to the menu by means of the [RETURN] key. (Setting of the RF level also in the LEVEL menu).
- SAVE** Opens the storing of the current instrument setting. Memory selection is effected by entering a number (1 to 50) and is finished by means of the [ENTER] key.
- RCL** Opens the calling of an instrument setting stored. Memory selection is effected by entering a number (1 to 50) and is finished by means of the [ENTER] key.

see as well
Chapter 2
Section
"Use of [FREQ] and [LEVEL] Keys"
Section
"RF Frequency"
Section
"RF Level"
Section
"Storing and Calling of Instrument Settings"

Numeric input field



Numeric values, decimal point and minus sign can be entered by means of the digital keys.,

- 0...9 Enters the digit.
- Enters the decimal point
 - /← Enters the minus sign.
Deletes the last input (digit, sign or decimal point) - key [BACKSPACE].

see as well
Chapter 2
Section
"Basic Operating Steps"

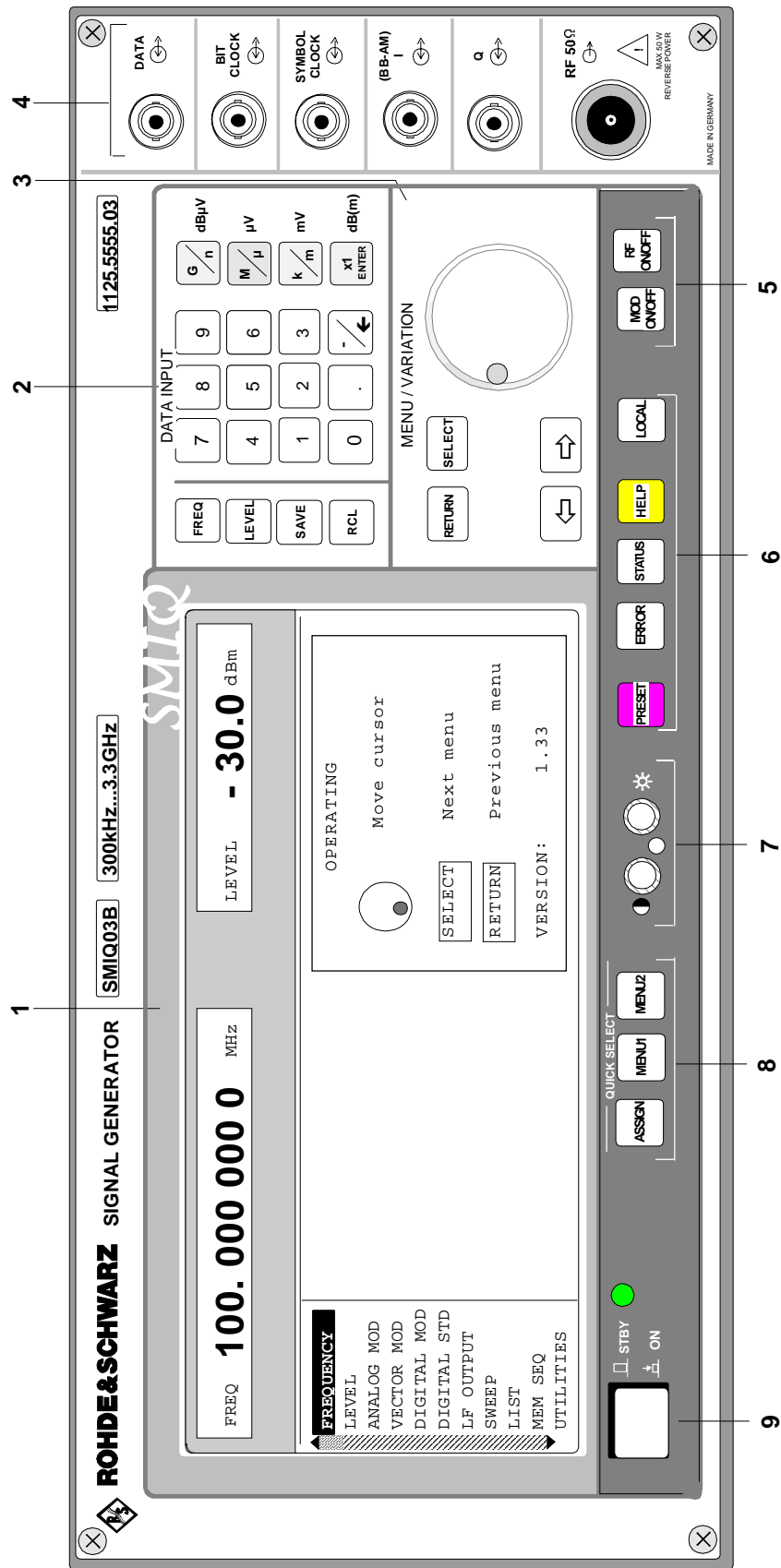
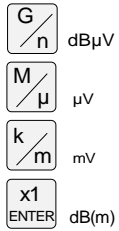

Fig. 2-1 Front panel view

2 DATA INPUT

Unit keys with enter function



The unit keys terminate the input of values and specify the multiplication factor for the respective basic unit. The basic units are displayed next to the input field while numbers are entered. In the case of level settings, the unit keys specify the unit.

G/n	dBμV	Selects giga/nano, with RF level dBμV, with LF level dBu.
M/μ	μV	Selects mega/micro, with level μV.
k/m	MV	Selects kilo/milli, with level mV.
1x		
Enter	dB(m)	Terminates entries in the basic unit and value inputs without unit. Selects with level dBm Selects with level offset and level step width dB.

In order to change to another level unit, simply press the unit key desired. Parameter LEVEL must be activated, e.g. by pressing the [LEVEL] key.

see as well
Chapter 2
Section
"Basic Operating Steps"

Section
"Change Unit of Level"

3 MENU/VARIATION

Menu keys

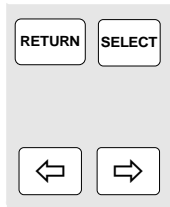

The menu keys access the menus and settings within the menus.

RETURN	Returns the menu cursor to the next higher menu level.
SELECT	Acknowledges the choice marked by the menu cursor
←	Moves the digit cursor to the left by one position in the marked value indication. Moves the menu cursor to the left by one position in a 1-out-of-n selection.
⇒	Moves the digit cursor to the right by one position in the marked value indication. Moves the menu cursor to the right by one position in a 1-out-of-n selection.

see as well
Chapter 2
Section
"Basic Operating Steps"

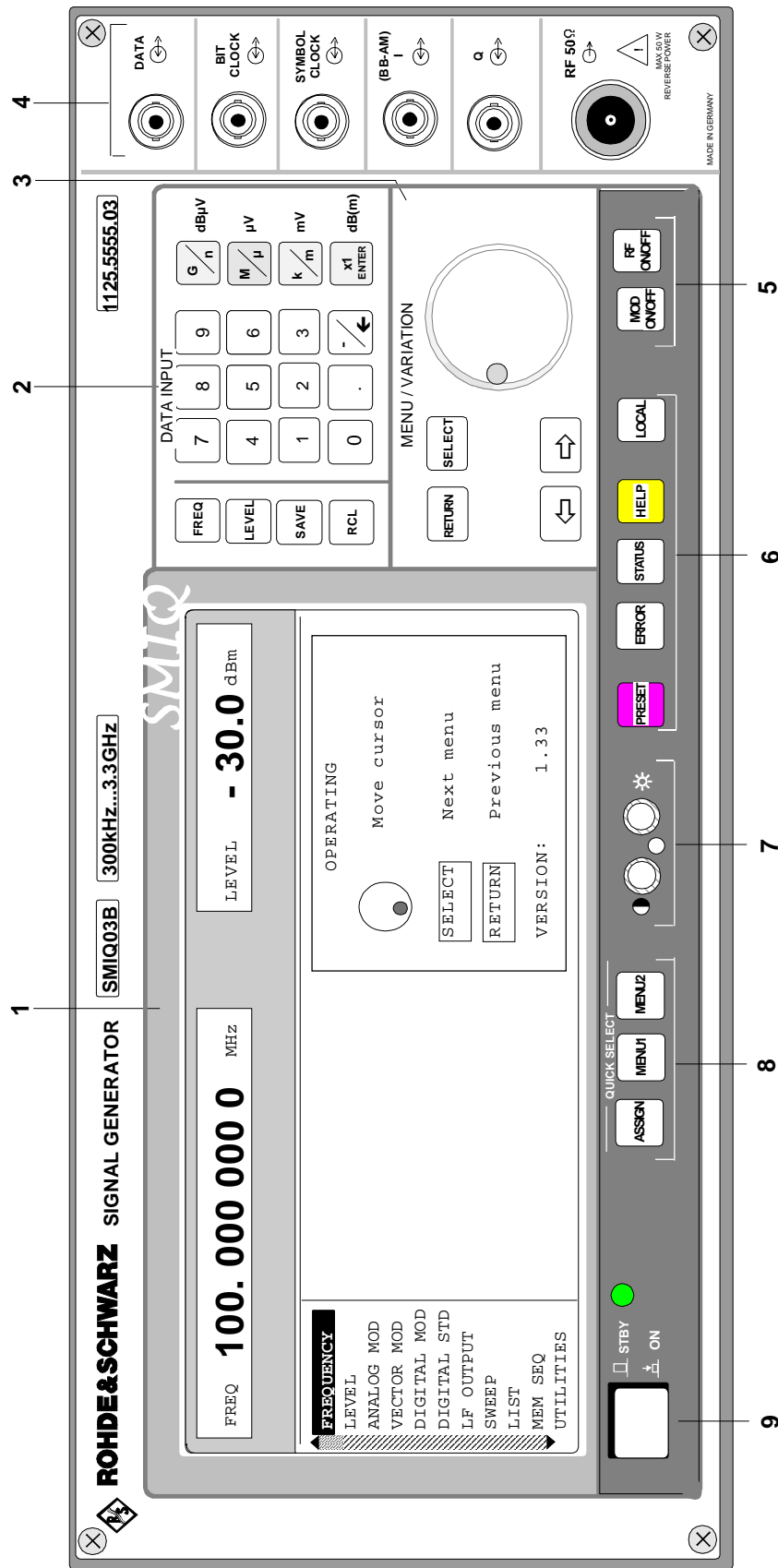
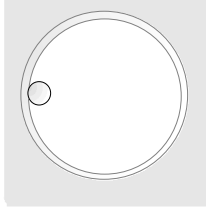

Fig. 2-1 Front panel view

3 MENU/VARIATION

Rotary knob



The rotary knob moves the menu cursor over the positions of a menu level to choose from or varies the value of a parameter. The variation is either effected in steps of one or in a step width that can be specified at will.

See as well
Chapter 2
Section "Basic
Operating Steps"
Section
"Sample Setting for
First Users"

4

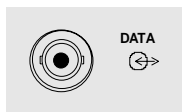

DATA

Input external data signal for digital modulation. Input resistance 1 k Ω or 50 Ω , Trigger threshold can be set from -2.5 to + 2.5V, max. \pm 15 V, max. 40 mA. Output* data signal with operating mode internal. Level: TTL

See as well
Chapter 2,
Section
"Digital Modulation"

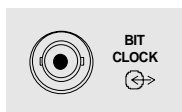

BIT CLOCK

Input* external clock-pulse signal for synchronization of external data signal. Input resistance 1 k Ω or 50 Ω , Trigger threshold can be set from -2.5 to + 2.5 V, max. \pm 15 V, max. 40 mA. Output* clock-pulse signal with operating mode internal. Level: TTL

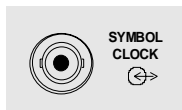

SYMBOL CLOCK

Input* external clock signal for synchronization of the external data signal with polyvalent modulation types with several bits per symbol. Input resistance 1 k Ω or 50 Ω , Trigger threshold can be set from -2.5 to + 2.5V, max. \pm 15 V, max. 40 mA. Output* symbol clock signal with operating mode internal. Level TTL

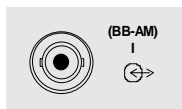

(BB-AM) I

Input external modulation signal for I/Q modulation and broadband-AM. Output* I-signal with operating mode internal. Input/output resistance 50 Ω . Nominal voltage (I/Q): $U_S = 0.5$ V
Nominal voltage (BB-AM): $U_S=0.25$ V
max. permissible overvoltage: \pm 5V

Section
"Vector Modulation"
and
Section
"Broadband AM"

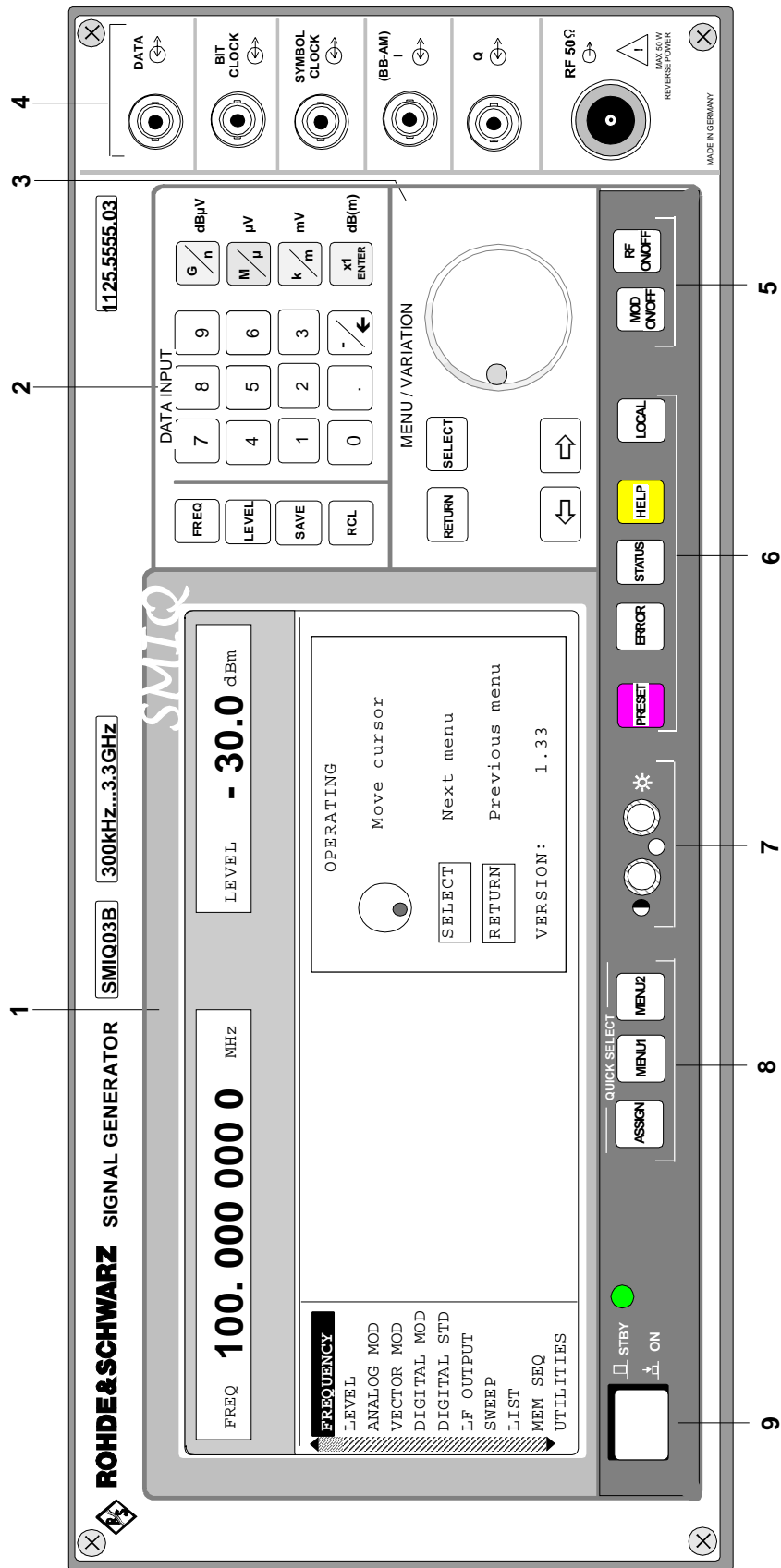
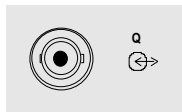

Fig. 2-1 Front panel view

4



Q

Input external modulation signal for I/Q modulation.
Output* Q-signal with operating mode internal.
Input/output resistance 50 Ω.
Nominal voltage: $U_S = 0.5 \text{ V}$
max. permissible overvoltage: $\pm 5 \text{ V}$

Section "Vector Modulation"

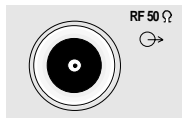

RF

Output RF signal.
Source resistance 50 Ω
max. permissible HF-power: 50 W
max. permissible overvoltage: 35 V

Section "Use of [ON/OFF] and [MOD ON/OFF] Key"

* When fitted with option Modulation coder, SMIQB20

5

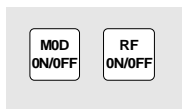

MOD ON/OFF

Switches on/off the modulation selected in the UTILITIES MOD KEY menu.

See as well Chapter 2 Section "Use of [RF ON/OFF] and [MOD ON/OFF] Keys"

RF ON/OFF

Switches on/off the RF signal.

6

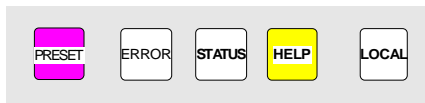

PRESET

Establishes a defined instrument status.

See as well Chapter 1 Section "Preset Setting"

ERROR*

Indicates error and caution messages.

Chapter 2 Section "Help System"

STATUS*

Indicates the instrument status.

Section "Status"

HELP*

Indicates context-sensitive auxiliary text.

Section "Error Messages"

LOCAL

Switches the instrument from the REMOTE mode (remote control) to the LOCAL mode (manual control).

Chapter 3, "Remote Control"

* Exit the menus using the [RETURN] key.

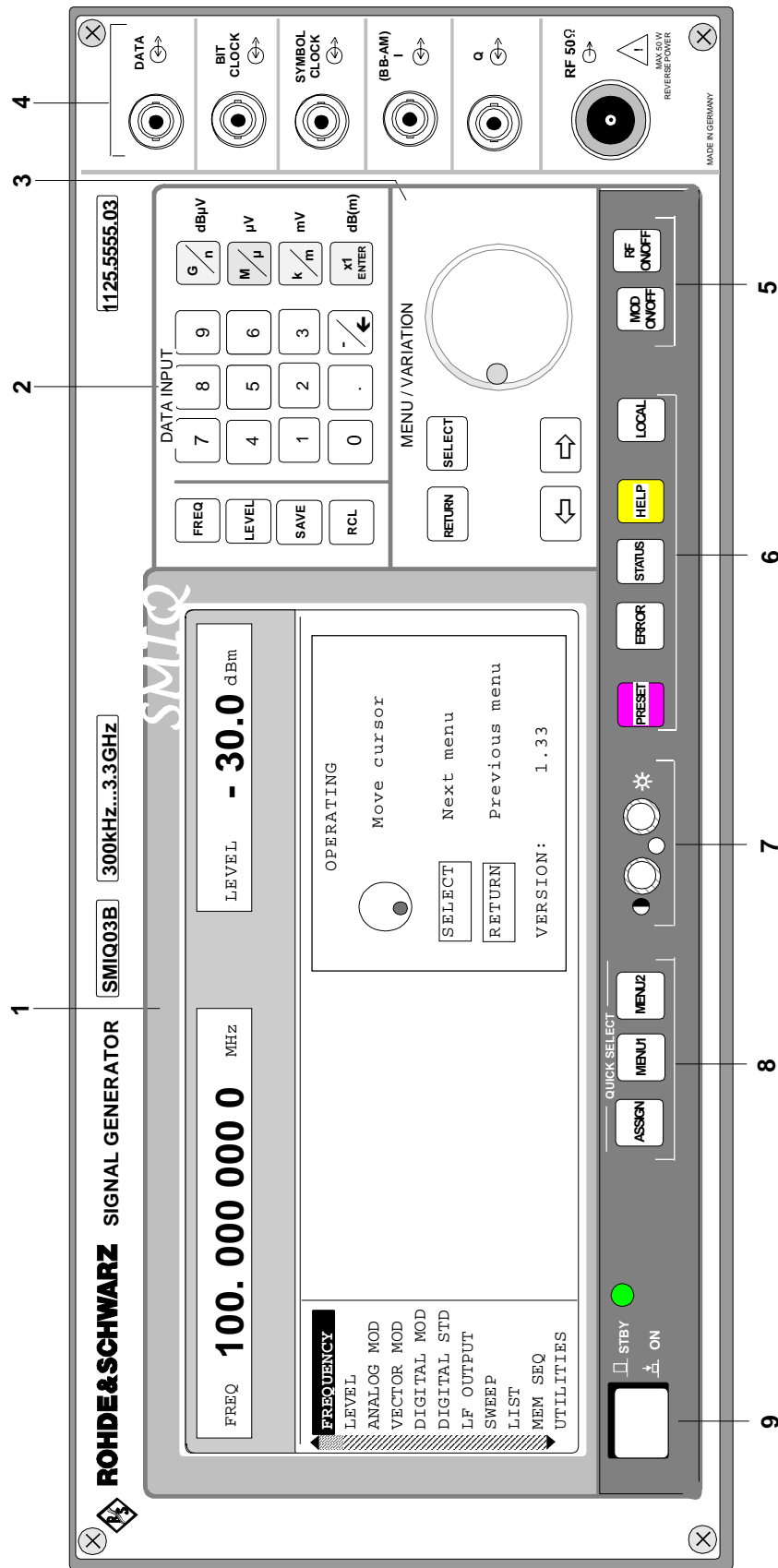
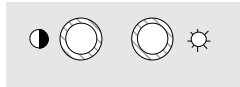

Fig. 2-1 Front panel view

7



Brightness and contrast of the display can be set using the rotary knobs.

- Contrast
- ☀ Brightness

See as well Chapter 1 Section "Setting of Contrast and Brightness of the Display"

8 QUICK SELECT

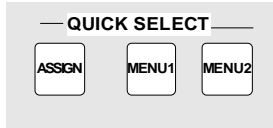

The menu-quick-selection keys permit fast access to two menus selected.

- ASSIGN Stores the current menu as menu1 when the MENU1 key is pressed afterwards or as menu2 when the MENU2 key is pressed afterwards.
- MENU1 Activates menu1 stored.
- MENU2 Activates menu2 stored.

See as well Chapter 2 Section "Basic Operating Steps"

9 Switching On/Off

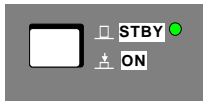

The On/Off switch switches the instrument from the standby mode to the ready-for-operation status. Prerequisite: The power switch at the rear of the instrument must be switched on.

- STBY LED is illuminated in the standby mode.

see as well Chapter 1 Section "Switching On/Off the Instrument" Chapter 2 Section "Elements of the Rear Panel, Power Switch"

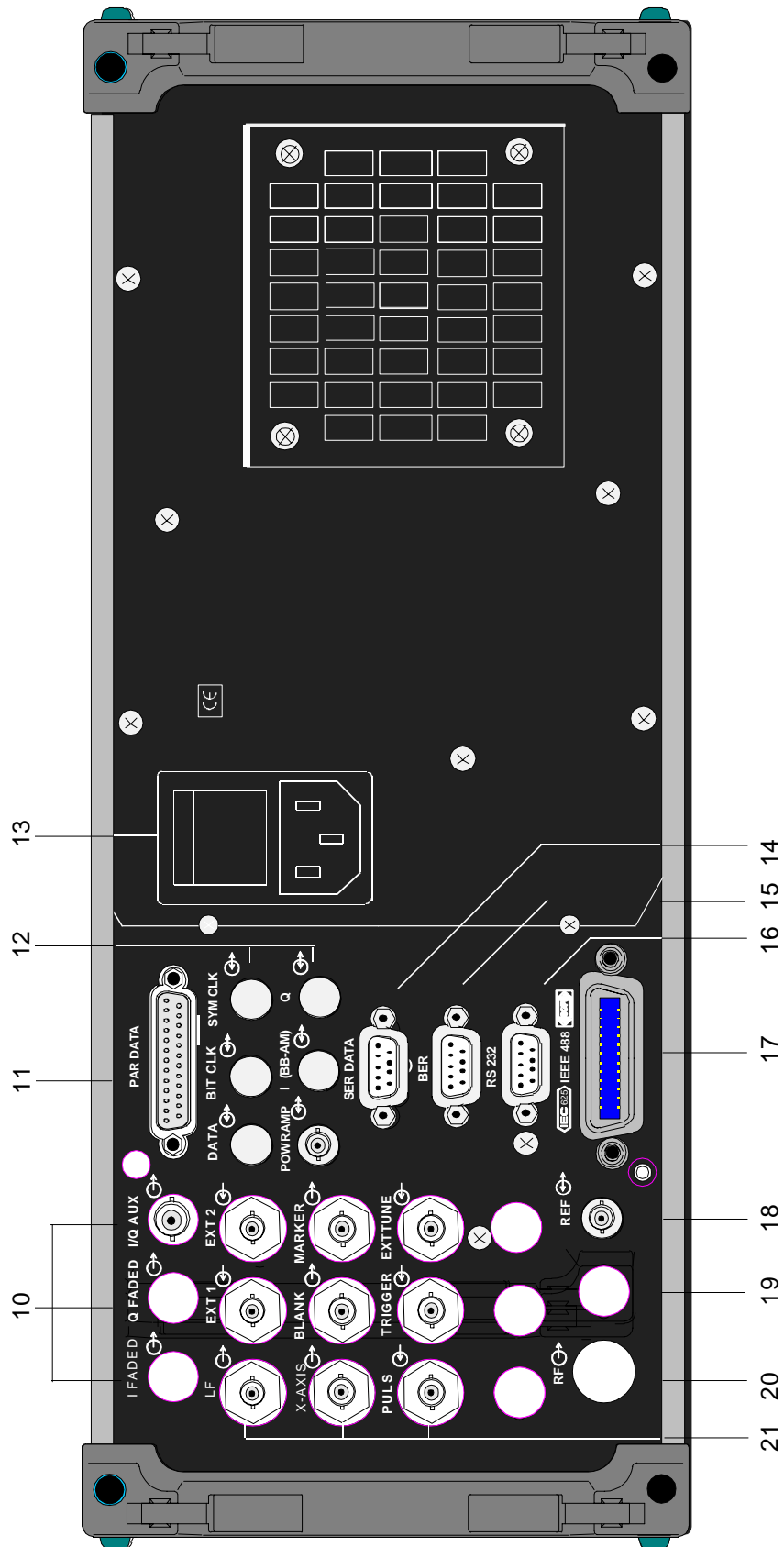
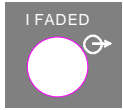

Fig. 2-2 Rear panel view

2.1.3 Elements of the Rear Panel

(Cf. Fig. 2-2, Rear panel view)

10



I FADED Faded I signal.



Q FADED Faded Q signal.



I/Q AUX Output I/Q modulated subcarrier. Frequency 300 MHz, level -5 dBm, source resistance 50Ω

see as well Chapter 2, "Fading Simulation"

11

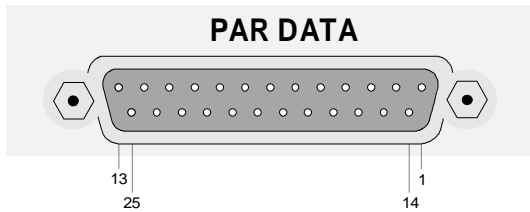

An adapter between the PAR DATA connector and coaxial BNC connectors is available as an accessory (SMIQ-Z5, order no. 1104.8555.02).

PAR DATA

Pin	Description
1 - ⊥	Ground
2 - ⊥	Ground
3 - DATA-D6	Parallel data input/output D0 to D6 for digital modulation. Output: TTL signal. Input: Input resistance 1kΩ or 50Ω. Trigger threshold can be set from -2.5 to 2.5V, max. ± 15V, max. 40 mA
4 - DATA-D4	
5 - DATA-D2	
6 - DATA-D0	
7 - SYMBCLK	Symbol clock input/output for synchronization of the data signal with modulation types with several bits per symbol. Output: TTL signal. Input: Input resistance 1kΩ or 50Ω. Trigger threshold can be set from -2.5 to 2.5V, max. ± 15V, max. 40 mA

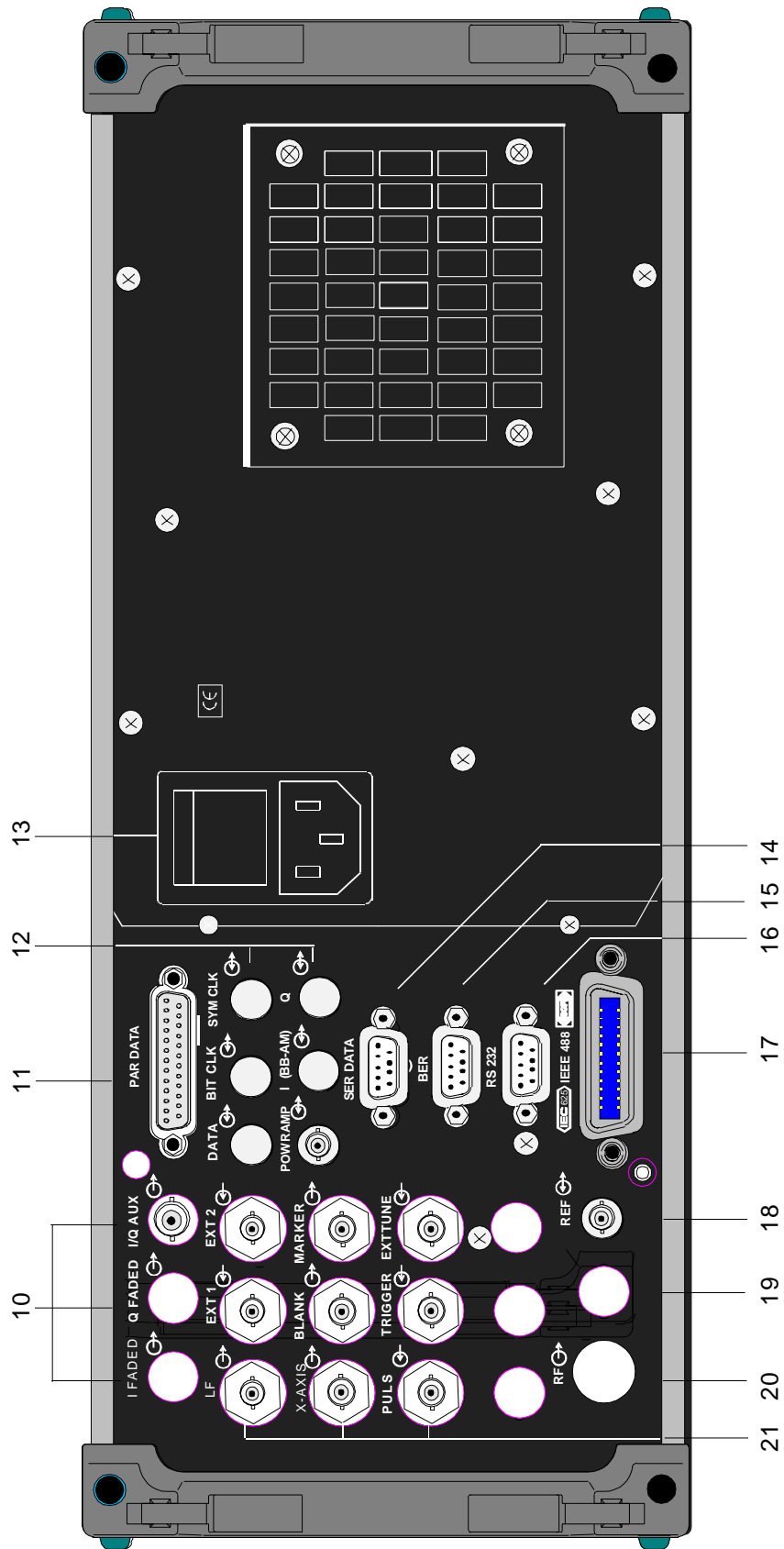

Fig. 2-2 Rear panel view

PAR DATA

Pin	Description
8 - \perp	Ground
9 - LEV-ATT	Signal input/output for controlling of level reduction. Output: TTL signal. Input: Input resistance 1k Ω or 50 Ω . Trigger threshold can be set from -2.5 to 2.5V, max. \pm 15V, max. 40 mA
10 - \perp	Ground
11 - TRIGOUT 1	Output for triggering of external instruments. Output: TTL signal.
12 - \perp	Ground
13 - \perp	Ground
14 - TRIGIN	Input for triggering of frames, PRBS and data sequences. Input: Input resistance 1k Ω or 50 Ω . Trigger threshold can be set from -2.5 to 2.5V, max. \pm 15V, max. 40 mA
15 - DATA-D7 16 - DATA-D5 17 - DATA-D3 18 - DATA-D1	Parallel data input/output D1to D7 see pin 3 - 6
19 - \perp	Ground
20 - BITCLK	Output bit clock with operating mode internal. TTL signal
21 - CW	Signal input/output for controlling of modulation. Switches carrier to CW with FSK modulation. Output: TTL signal. Input: input resistance 1k Ω or 50 Ω . Trigger threshold can be set from -2.5 to 2.5V, max. \pm 15V, max. 40 mA
22 - BURST-GATE	Signal input/output for controlling of the burst profile. Output: TTL signal. Input: input resistance 1k Ω or 50 Ω . Trigger threshold can be set from -2.5 to 2.5V, max. \pm 15V, max. 40 mA
23 - TRIGOUT 2	Output for triggering and controlling of external instruments. Output: TTL signal.
24 - TRIGOUT 3	Output for triggering and controlling of external instruments. Output: TTL signal.
25 - HOP	HOP output provides control signal when internal frequency hopping is programmed. Output: TTL signal

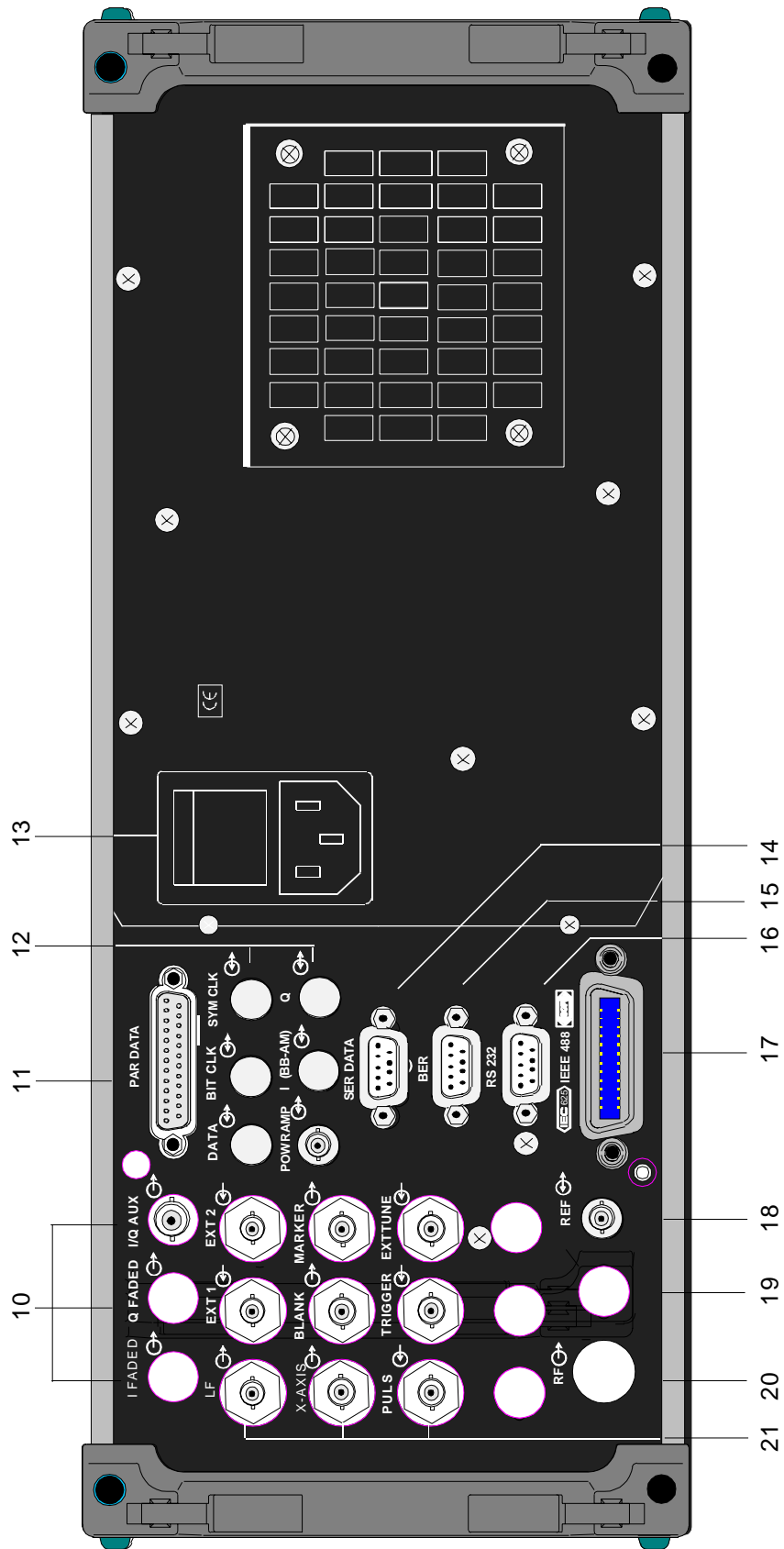

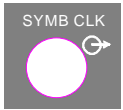
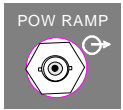
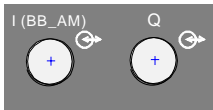
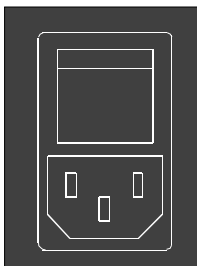

Fig. 2-2 Rear panel view

12

	DATA	Cut-out, provided to relocate the DATA input/output at the front to the rear of the instrument.
	BIT CLK	Cut-out, provided to relocate the BIT CLK input/output at the front to the rear of the instrument.
	SYMB CLK	Cut-out, provided to relocate the SYMB CLK input/output at the front to the rear of the instrument.
	POW RAMP	Signal input/output for power ramping. Input: accepts analog voltages from 0 to 1 V for envelope modulation. Input resistance 10k Ω Max. permissible overvoltage ± 15 V Output provides modulation voltage of burst envelope with internal modulation. output resistance 10 Ω Max. permissible overvoltage ± 15 V
	I (BB-AM) Q	Cut-out, provided to relocate the I- input at the front to the rear of the instrument. Cut-out, provided to relocate the Q- input at the front to the rear of the instrument.

13

	Power switch	ON when pressed at the top ("I")	see as well Chapter 1, Section "Supply Voltage" Section "Switching On/Off the Instrument"
	Power supply connection		

14

	SER DATA	Asynchronous data input for digital modulation. Interface: RS232 up to 115 kbps	see as well Annex A "interfaces"
---	----------	--	--

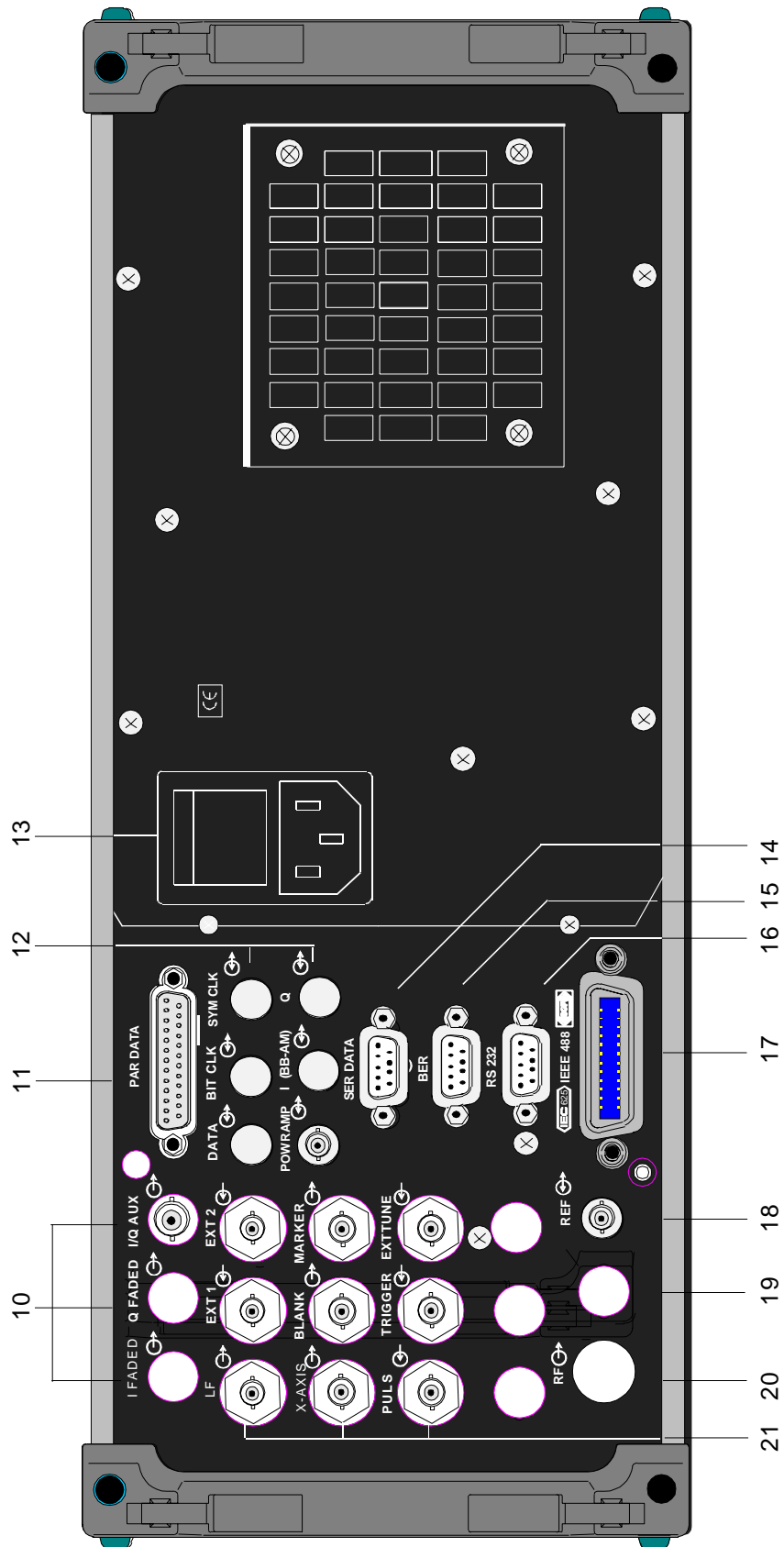
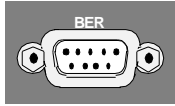

Fig. 2-2 Rear panel view

15



Interface for BER Test

See as well chapter 2, section "External Modulation Source AMIQ" and "Bit Error Rate Test"

16

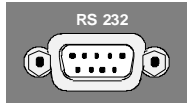

RS-232

RS-232 interface, used for software update, the loading of calibration data, and remote control. The pin assignment corresponds to the pin assignment of a PC.

see as well Chapter 3 Remote Control and Annex A "Interfaces"

17

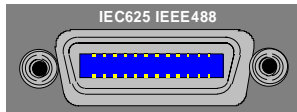

IEC 625
IEEE 488

IEC-Bus (IEEE 488)
Remote-control interface

See as well Chapter 3, "Remote Control"

18

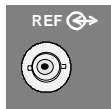

REF

Output of the internal 10-MHz reference signal with reference internal. Source resistance 50 Ω. Input for external reference frequency with reference external. Adjustable to external reference frequencies from 1 to 16 MHz in 1-MHz steps. Input resistance 200 Ω.

See as well Chapter 2, Section "Reference Frequency int/ext"

19



4 optional cut-outs, provided for further connections

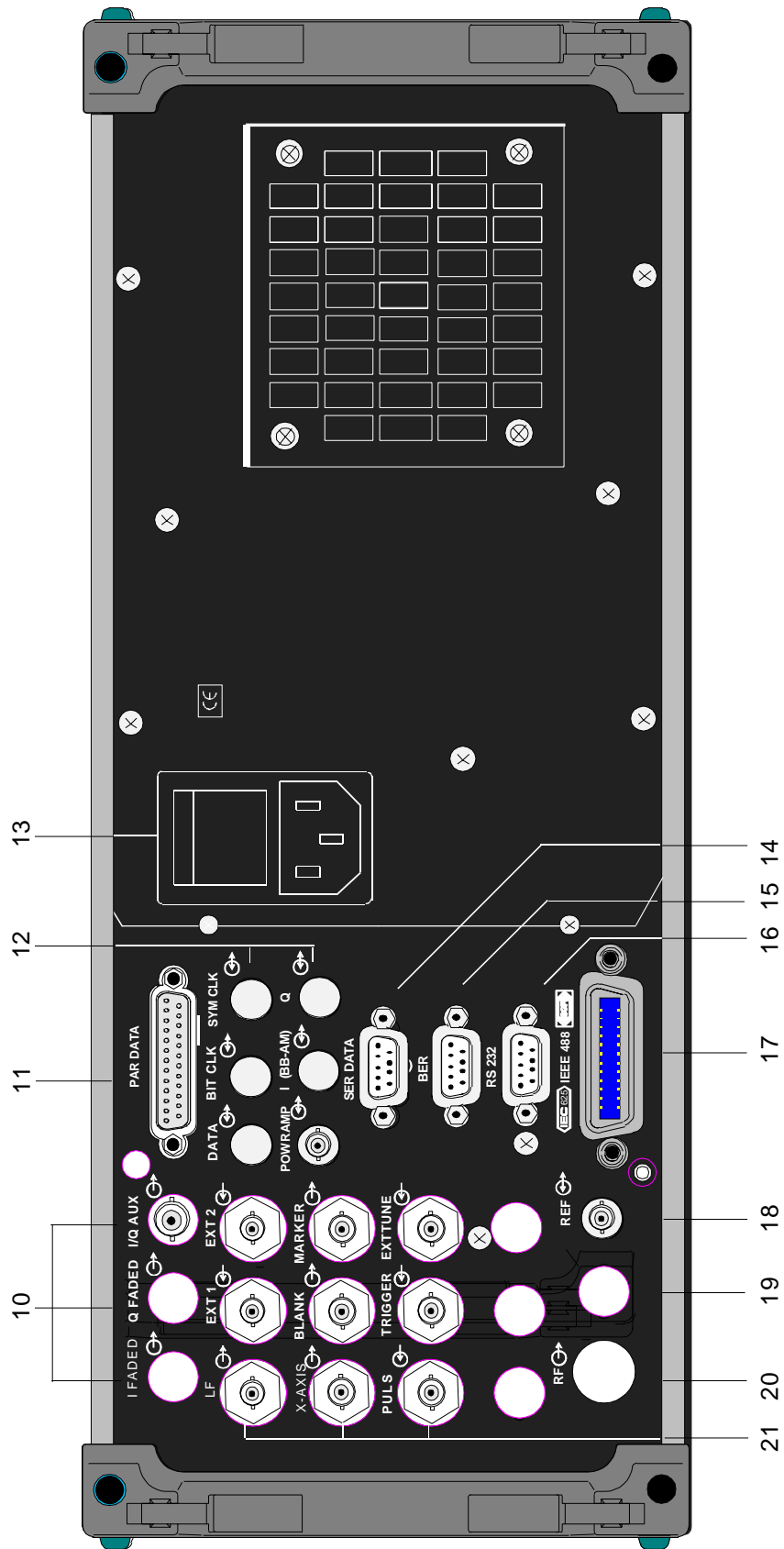
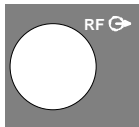

Fig. 2-2 Rear panel view

20



RF Cut-out, provided to relocate the RF output at the front to the rear of the instrument

21

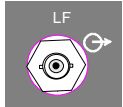

LF Output LF signal of the internal LF generator.
Source resistance <math>< 10 \Omega</math>.



EXT1 Input external modulation signal, alternatively for AM or FM (PM).
Input resistance >100 k Ω .
Nominal voltage: $U_S = 1 \text{ V}$
Max. permissible overvoltage: $\pm 15 \text{ V}$

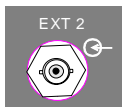

EXT2 Input external modulation signal for FM (PM).
Input resistance >100 k Ω .
Nominal voltage: $U_S = 1 \text{ V}$
Max. permissible overvoltage: $\pm 15 \text{ V}$



X-AXIS Output supplies a voltage ramp of 0 to 10 V, when a sweep is switched on.



BLANK Output supplies a signal to blank the return sweep or the settling process in LIST mode
Level: TTL



MARKER Output is active when the sweep reaches the marker or at the first step of the LIST mode. Level: TTL

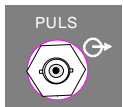

PULS Input for pulse modulation. Level: TTL
Input resistance 10 Ω



TRIGGER Input to trigger sweep, LIST mode and Memory Sequence. Level: TTL



EXTTUNE Tuning input for the internal reference frequency. Voltage range $\pm 10 \text{ V}$, pulling range $\pm 1 \cdot 10^{-6}$

2.2 Basic Operating Steps

The operating principle is explained in this section. For better understanding, please read section "Sample Setting for First Users" (Section 2.2.10) in addition.

To operate the instrument, menus are called in the display. All setting possibilities and the current setting status are evident from the menus. All settings can be made by accessing the menus.

RF frequency and RF level can also be set without menu operation using keys [FREQ] and [LEVEL]. RF signal and modulation can also be switched on/off without menu operation using keys [RF ON/OFF] and/or [MOD ON/OFF].

2.2.1 Design of the Display

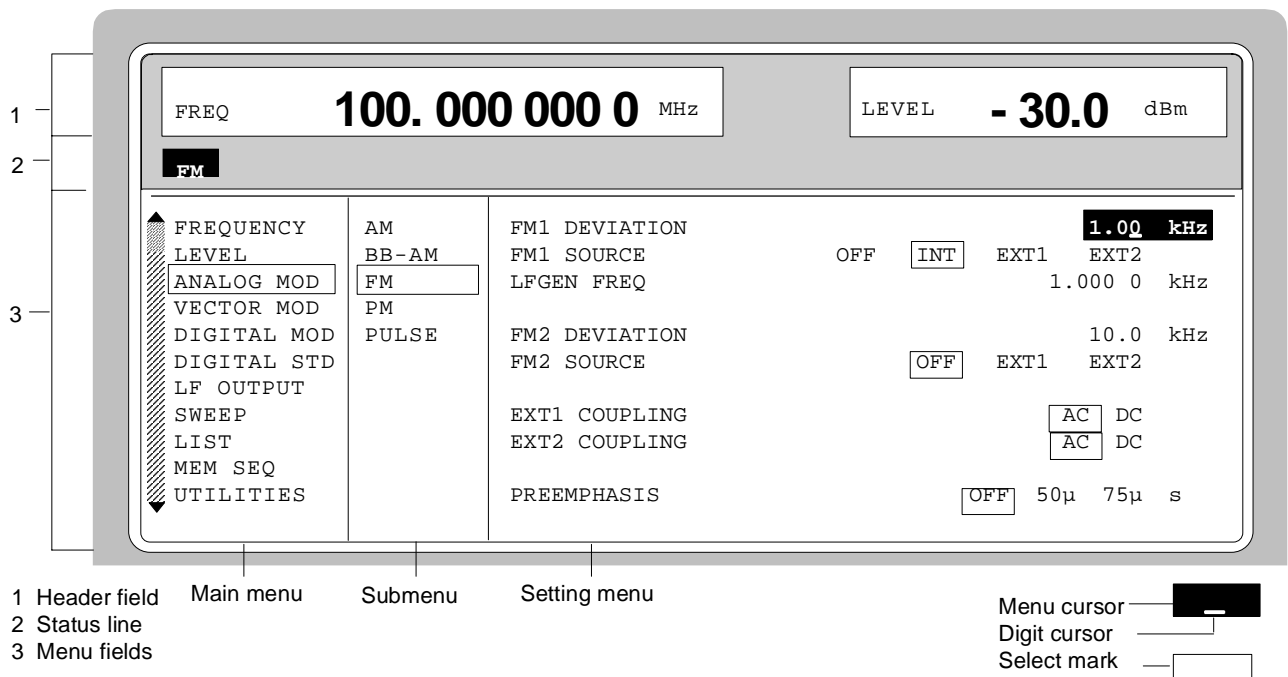

Fig. 2-3 Design of the display

Header field (1) The header field of the display indicates frequency and level of the RF output signal which considers the offset value. In the RF-sweep operating mode, the start and stop frequencies are displayed in two lines one above the other. The start and stop levels are indicated in the LEVEL-sweep operating mode correspondingly. A two-line level display appears for digital modulation or digital standard. The upper line indicates the average power (LEVEL), the lower line the peak envelope power (PEP) of the modulated RF output signal.

Status line (2) The status line below describes operating mode and operating state of the instrument. Error messages and notes for caution are also displayed in the status line.

Menu fields (3)The indication fields below the header field are reserved for the menu representations. The image contents of these fields change as a function of the menu selected. The field at the left-hand display margin is occupied with the main menu, the topmost level of the menu structure. The main menu is always faded in.

Each further field adjacent at the right contains submenus.

The field ending with the right-hand display margin shows the setting menu. In this menu all setting values and setting states connected with the menu selected are indicated. When accessing submenus, the higher-order menus remain in the display. The current menu path is evident through the select marks.

Menu cursor The menu cursor shows the user at which position in the menu he is. The position of the menu cursor is evident from the inverse notation of the term (white characters on a black background)

Digit cursor As an underscore, the digit cursor marks the position which can be varied by means of the rotary knob in a value indication.

Select mark The frame around a term marks current menus or valid settings in the setting menu.

2.2.2 Calling the Menus

Accessing the menus is effected using rotary knob [VARIATION], [SELECT] key and [RETURN] key.

Rotary knob Rotary knob [VARIATION] moves the menu cursor over the positions of a menu level to be selected. If a scrollbar is visible at the left-hand margin of a menu, the menu is larger than the screen window. If the menu cursor is moved to the margin of the screen window, the covered lines become visible.

[SELECT] key The [SELECT] acknowledges the selection marked by means of the menu cursor.

[RETURN] key The [RETURN] key

- returns the menu cursor to the next higher menu level. The menu cursor is shifted to the left into the preceding column of the menu structure.
- resets the menu cursor from frequency or level value indication in the header field into the menu field to the menu called last.
- closes the display pages called using keys [STATUS], [HELP] and [ERROR] again.

Settings are accessed in the setting menus ending with the right-hand display margin.

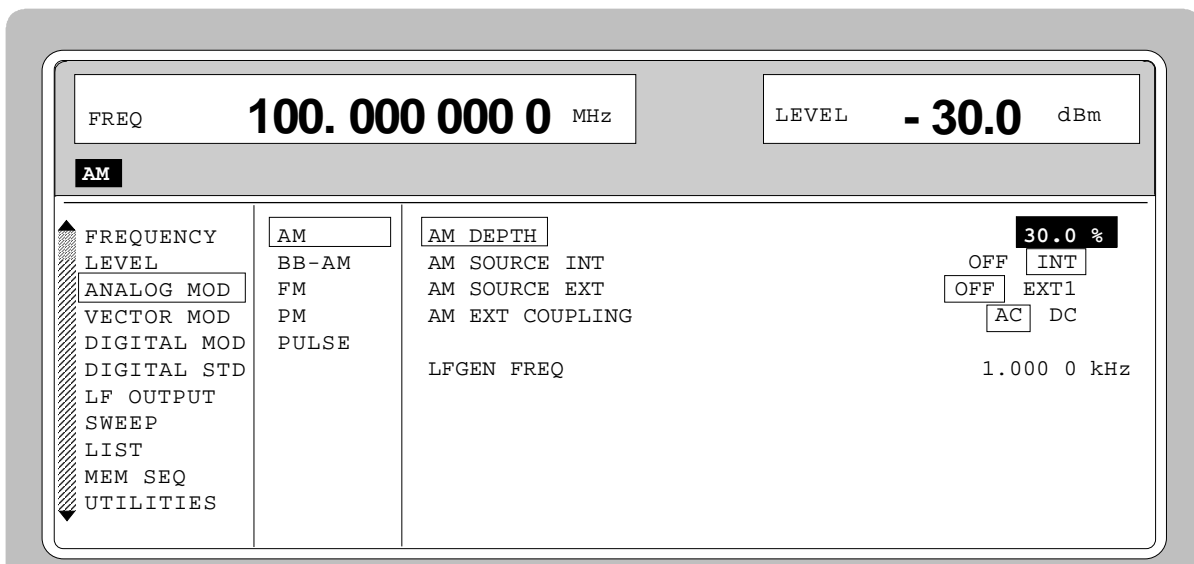

Fig. 2-4 MODULATION-AM menu

2.2.3 Selection and Change of Parameters

- Select parameter** ➤ Set the menu cursor to the name of the parameter desired using the rotary knob, e.g. to AM DEPTH in the AM menu, Fig. 2.4.
- Change setting value**
- via value inputs
- Via value input or using rotary knob.
 - Press the first digit of the new value or minus sign. The old value is deleted, the entry is indicated in the marked field.
 - Enter further digits.
 - Terminate the input using a unit key or, in the case of inputs in the base unit or in the case of inputs without unit, using the [1x/Enter] key. The menu cursor wraps back to the appropriate parameter.
- using rotary knob
- Press the [SELECT] key.
 - The menu cursor changes from the parameter selected in the left-hand column of the setting menu to the setting value on the right, e.g. from AM DEPTH to 30%, Fig. 2-4.
 - Set the underscore to the position of the setting value to be varied using keys [⇒] [⇐].
 - Turn the rotary knob.
The position underscored is varied in steps of 1.
- Note:** *RF frequency and RF level can also be varied in a step width which can be defined arbitrarily using the rotary knob. In the respective setting menu (FREQUENCY or LEVEL) the step width is entered as KNOB STEP USER and the KNOB STEP set from DECIMAL to USER. To point to the fact that the step width has been converted to the value programmed, the underscore as a symbol of the digit cursor disappears in the respective value indication.*
- 1-out-of-n selection**
- Select parameters.
 - Press the [SELECT] key.
The menu cursor changes from the parameter selected in the left-hand column of the setting menu to the current selection on the right, e.g. from AM SOURCE EXT to OFF, Fig. 2-4.
 - Set the menu cursor to the position desired within the 1-out-of-n selection using the rotary knob or cursor keys [⇐] [⇒].
 - Press the [SELECT] key.
The setting is made.
The selection mark which has marked the setting valid up to now wraps to the new position.
 - Press the [RETURN] key.
The menu cursor wraps back to the respective parameter.

Quick selection of a parameter

The quick selection of a parameter reduces the number of operating steps if several parameters are set successively. The menu cursor can directly be set further from line to line in the column of the setting values by pressing the [SELECT] key.

The menu cursor wraps from the setting value of a parameter to the setting value of the parameter in the next line.

The column of the setting values can be exited at each position by pressing the [RETURN] key.

2.2.4 Triggering Action

Lines in the setting menu which are marked with the "▶" symbol at the end of the line qualify an action which can be carried out. Instruction SEARCH ONCE ▶ in the LEVEL-ALC menu, e.g., switches on level control for level calibration for a short period of time.

Trigger action

- Set the menu cursor to the respective instruction.
- Press the [SELECT] key.
The action is triggered.
While the action is carried out, the instruction remains framed by the selection mark.

2.2.5 Quick Selection of Menu (QUICK SELECT)

The keys of the QUICK SELECT control field are used to call selected menus quickly by one keystroke.

Store menus

- Establish the desired operating status of the current menu.
- Press the [ASSIGN] key.
- Press key [MENU1] or [MENU2].
The current menu is stored as menu1 or menu2. That is to say, 2 menus can be stored in total.

Call menus

- Press key [MENU1] or [MENU2].
Menu1 or menu2 stored is displayed. Exactly the operating status which was current at the point of time of storing is reconstructed.

2.2.6 Use of [FREQ] and [LEVEL] Keys

RF frequency and RF level can be set without menu operation as well using direct keys [FREQ] and [LEVEL]. The input value considers the offset, see Sections 2.4 and 2.5.

- Key [FREQ]/ [LEVEL]**
- Press the [FREQ] or [LEVEL] key.
 - The frequency and/or the level indication in the header field of the display is marked.
 - The current menu at the display is maintained.
 - Alter the value via a value input or the rotary knob.
 - Press the [RETURN] key.
 - The menu cursor wraps to the position marked last in the menu.

2.2.7 Use of [RF ON/OFF] and [MOD ON/OFF] Keys

RF signal and modulation can be switched on/off without menu operation as well using direct keys [RF ON/OFF] and/or [MOD ON/OFF] (see Sections [RF ON/OFF] key and [MOD ON/OFF] key as well).

- Key [RF ON/OFF]**
- Press the [RF ON/OFF] key.
 - The RF output signal is switched on/off.
 - IEC-bus-short command: :OUTP OFF

- Key [MOD ON/OFF]**
- Press the [MOD ON/OFF] key.
 - The modulation is switched on/off.
 - An IEC-bus command is not available. The modulations have to be switched on and off in the respective modulation sub menus

2.2.8 [ENTER] Key – Special Toggle Function

This additional function of the [ENTER] key facilitates parameter changes.

Some selection parameters can now be selected using the [ENTER] key, and no longer have to be activated beforehand with [SELECT].

2.2.9 Changing Unit of Level

For the level, the unit of the value set can be changed without a new value input.

- Change level unit**
- Activate LEVEL parameter.
 - Press the [LEVEL] key or
 - set the menu cursor in the LEVEL menu to the setting value of the AMPLITUDE parameter.
 - Press the unit key with the desired level unit.
 - The level is indicated in the desired unit.

2.2.10 Correction of Input

Digital entries can be corrected by one of the following keys before terminating the input:

Key [-/←] The backspace key deletes the value entered digit by digit. When the last digit is deleted, the previous value is displayed.

Key [RETURN] Pressing the [RETURN] key deletes the entire entry and results in the previous value being indicated again.

For a subsequent new input in the setting menu, the first digit of the new value is to be entered.

For a subsequent new input via the [FREQ] or [LEVEL] keys, the respective key has to be pressed again.











Key [FREQ]/ [LEVEL] In the case of a frequency or level input by means of the [FREQ] or [LEVEL] keys, pressing the [FREQ] and/or [LEVEL] key again deletes the entire input.

2.2.11 Sample Setting for First Users

First users most quickly become familiar with the operation of the instrument if they execute the pattern setting of this section.









First frequency and level of the RF output signal are set via keys [FREQ] and [LEVEL] in the DATA INPUT field:

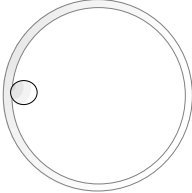

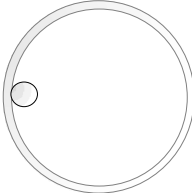

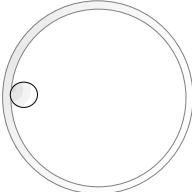
- Frequency 250 MHz
- Level 10 dBm

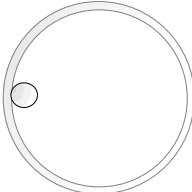
Operating steps	Explanations
	Reset the instrument to the defined state.
<p style="text-align: center;">DATA INPUT</p>     	Set the frequency to 250 MHz. The menu cursor marks the permanent frequency indication.
<p style="text-align: center;">DATA INPUT</p>    	Set the level to 10 dBm. The menu cursor marks the permanent level indication.
	Reset the menu cursor to the menu field.

The output signal is to be amplitude-modulated next.

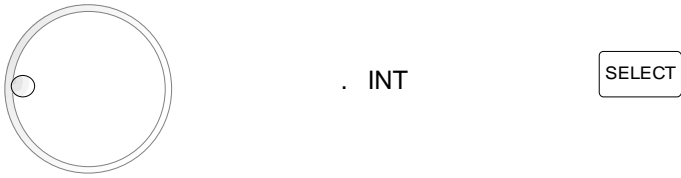
- AM modulation depth 15.5 %
- Modulation frequency 3 kHz

Operating steps		Explanations
<p>MENU / VARIATION</p>  <p style="text-align: center;">. ANALOG MOD .</p> <p>MENU / VARIATION</p> 	<p>Select ANALOG MOD menu.</p> <p>➤ Set menu cursor to ANALOG MOD using the rotary knob and subsequently press [SELECT] key.</p> <p>The submenu is displayed.</p>	
<p>MENU / VARIATION</p>  <p style="text-align: center;">. AM .</p> <p>MENU / VARIATION</p> 	<p>Select AM submenu</p> <p>The AM setting menu is displayed.</p>	
<p>MENU / VARIATION</p>  <p style="text-align: center;">. AM DEPTH .</p>	<p>Select AM DEPTH parameter.</p> <p>The menu cursor marks the setting value.</p>	
<p>DATA INPUT</p> 	<p>Enter modulation depth 15.5 % and press [x1 ENTER].</p> <p>The menu cursor is reset to AM DEPTH.</p>	
<p>MENU / VARIATION</p>  <p style="text-align: center;">. AM SOURCE INT .</p> <p>MENU / VARIATION</p> 	<p>Select AM SOURCE INT.</p> <p>The menu cursor marks the current 1-out-of-n selection.</p>	

Operating steps	Explanations
<p>MENU / VARIATION</p> 	<p>Select INT 1 as internal modulation source.</p> <p>The selection mark marks INT. AM is faded in the status line as a hint that AM is switched on.</p>
<p>RETURN</p> 	<p>Reset menu cursor to AM SOURCE INT.</p>
<p>MENU / VARIATION</p> 	<p>Select parameter LFGEN FREQ.</p>
<p>DATA INPUT</p> 	<p>Enter frequency 3 kHz and press unit key.</p> <p>The indications on the display are represented in Fig. 2-5.</p> <p>The AM modulation setting is completed.</p>

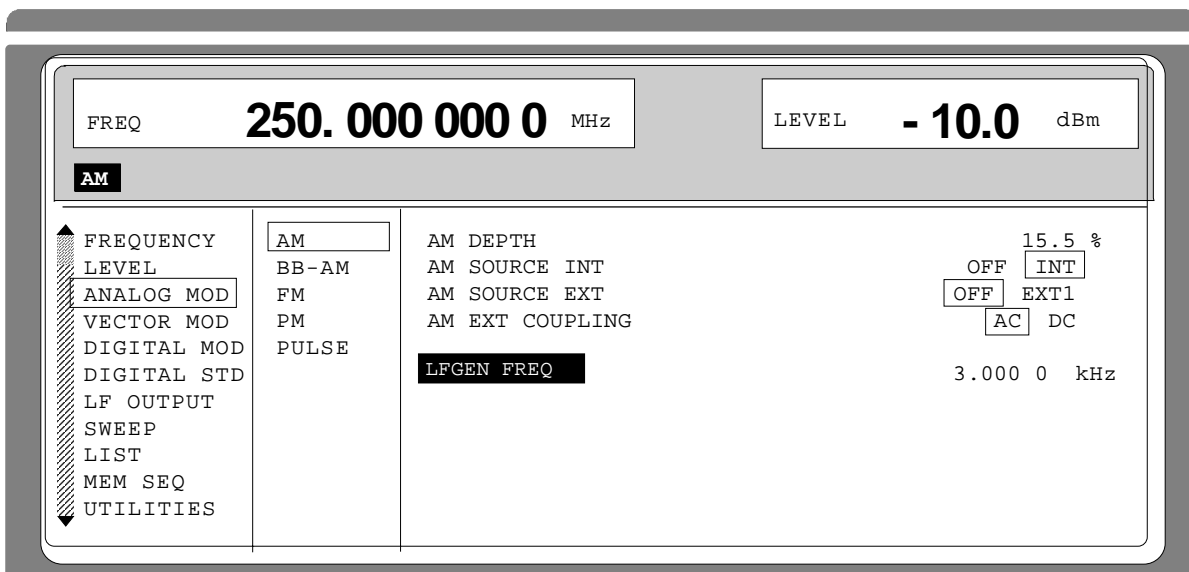

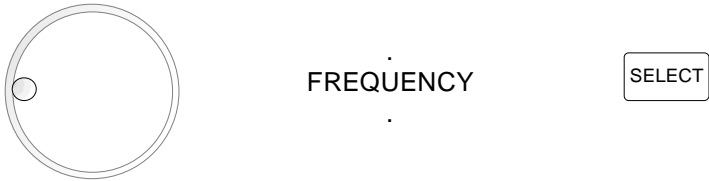

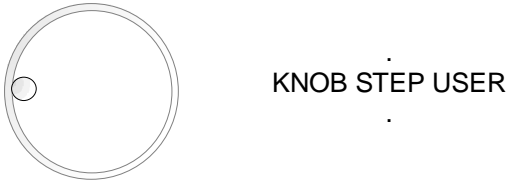

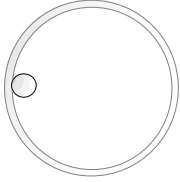
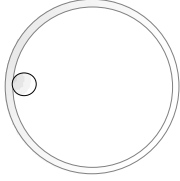

Fig. 2-5 Display after AM setting

Subsequently to the above setting, 420 MHz as new RF frequency and 12.5 kHz as the step width for the RF frequency variation are set in the following. Parameter quick select is used, which reduces the number of operating steps.

Operating steps	Explanations
	Reset the menu cursor to the main menu in 2 steps.
<p>MENU / VARIATION</p> 	Select FREQUENCY menu. The frequency setting menu is displayed.
<p>MENU / VARIATION</p> 	Select FREQUENCY parameter. The menu cursor marks the setting value.
<p>DATA INPUT</p> 	Enter frequency 420 MHz and press unit key.
<p>MENU / VARIATION</p> 	Set menu cursor to parameter KNOB STEP USER.
<p>DATA INPUT</p> 	Enter step width 12.5 kHz. Press unit key.

Operating steps	Explanations
<p>MENU / VARIATION</p>  <p style="text-align: center;">KNOB STEP</p>	<p>Set menu cursor to parameter KNOB STEP.</p>
<p><input type="button" value="SELECT"/></p>	<p>Set menu cursor to the current KNOB STEP selection.</p>
<p>MENU / VARIATION</p>  <p style="text-align: center;">USER</p> <p style="text-align: right;">MENU / VARIATION</p> <p style="text-align: right;"><input type="button" value="SELECT"/></p>	<p>Select USER (user-defined step width). The selection mark marks USER.</p> <p>This results in step width 12.5 kHz being used in the case of variation using the rotary knob.</p>
<p><input type="button" value="RETURN"/> <input type="button" value="RETURN"/></p>	<p>Reset the menu cursor to the main menu in 2 steps.</p>

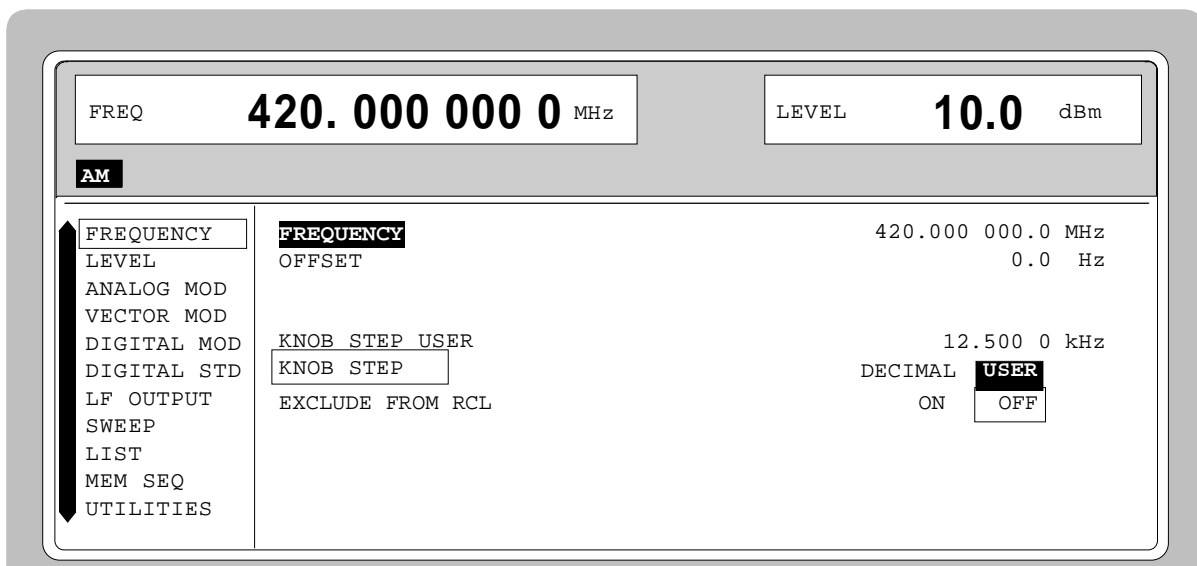

Fig. 2-6 Display after pattern setting

2.2.12 List Editor

The SMIQ offers the possibility to generate lists. Lists are used for setting sequences LIST mode or (memory sequence), as data source for digital modulations or for level correction which can be defined by the user (UCOR). They consist of elements which are defined by an index and at least one parameter per index. Each list is marked by a separate name and can be selected via this name. The lists are accessed in the menus assigned in each case, e.g. to the settings sequences of instrument settings in the MEM SEQ menu. However, the lists are always generated and processed in the same way and the procedures are hence explained in detail by the example of the memory sequence mode (menu MEM SEQ) in this section. A pattern setting at the end of this section allows the user to become familiar with the operation of the list editor.

Setting menus providing list processing are structured in two pages:

The first page, called OPERATION page in the following contains the general configuration parameters for processing a list. Further, the general list functions such as selecting and deleting the list as well as calling an editing mode are provided. The second page, the EDIT page, is automatically displayed when calling an edit function and serves to enter and modify the parameters of the list.

The OPERATION page has a similar arrangement with all list editors. As an example, the OPERATION page of the MEM SEQ menu is shown:

Menu selection: MEM SEQ

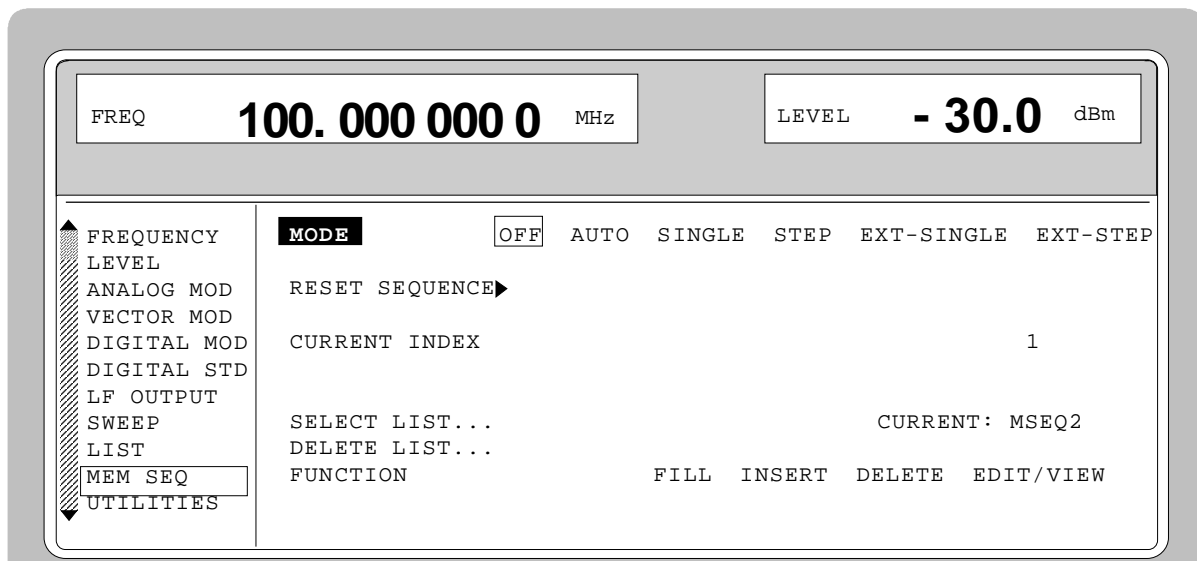

Fig. 2-7 OPERATION page of the MEM SEQ menu

The settings for MODE, CURRENT INDEX, etc. are irrelevant for the general description of the list editors and are described in greater detail in Section 2.10, MEMORY SEQUENCE mode.

The last three menu lines of the OPERATION page always exist and are reserved for selecting and deleting lists as well as for calling the edit functions (and hence the EDIT page).

SELECT LIST Opens a selection window in which a list can be selected from the existing lists or a new, empty list can be generated. In this line the active list is always displayed.

DELETE LIST	Opens a selection window in which the list to be deleted can be selected.
FUNCTION	Selection of the edit function for processing the lists. The EDIT page is automatically called through the selection (cf. Section 2.2.11.3).
FILL	Filling a list with elements.
INSERT	Insertion of elements into a list.
DELETE	Deletion of elements of a list.
EDIT/VIEW	Editing the single elements.

2.2.12.1 Select and Generate - SELECT LIST

SELECT LIST opens a selection window in which either an existing list can be selected or a new, empty list can be generated (cf. Fig. 2-8). By pressing the [RETURN] key, the selection window is closed without changing the setting.

- Select list
- Mark the list desired using the rotary knob.
 - Press [SELECT] key.

The selected list is included in the instrument setting. The selection window is closed. The selected list is displayed under CURRENT.
- Generate list
- Mark CREATE NEW LIST ► using rotary knob.
 - Press [SELECT] key.

A new empty list is automatically generated which can be filled using functions FILL or EDIT. The selection window is closed. The new list is displayed under CURRENT.
- No modification of the setting
- Press [RETURN] key.

Selection: SELECT LIST

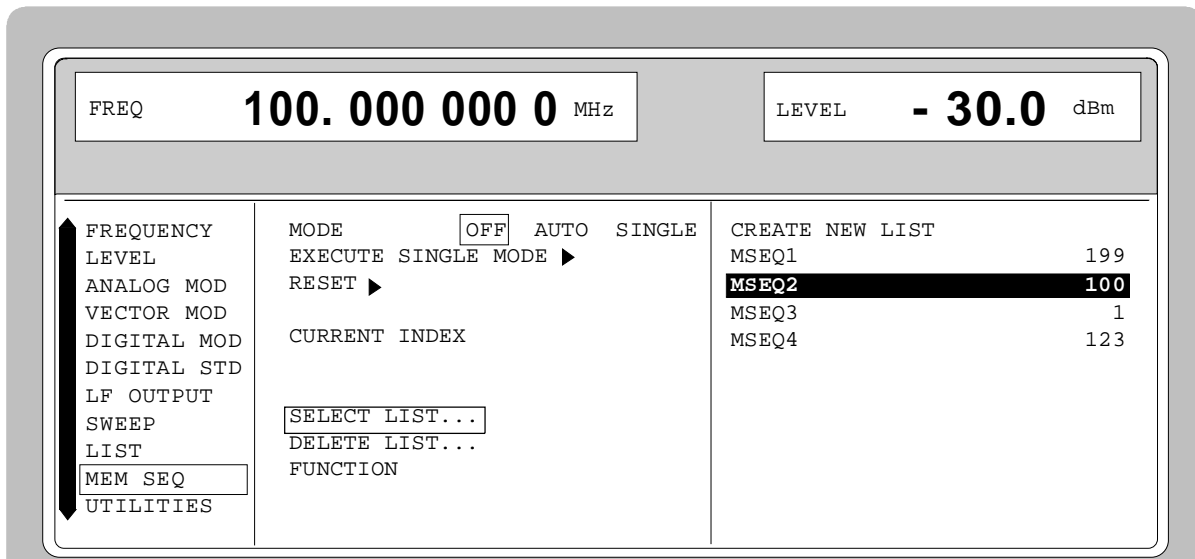

Fig. 2-8 SELECT-LIST-selection window

CREATE NEW LIST ► Generating a new list. The name of the list cannot be selected freely in the case of manual control. A definite list name is automatically generated in the following form:

MSEQ<n>, with <n> ∈ {0..9}, e.g. MSEQ1 (with Memory Sequence)

This applies correspondingly to the other operating modes. In the case of level correction mode, UCOR1 would be generated for example. If a list is created via IEC bus, an arbitrary list name can be given (cf. Section 3). Unrestricted access is also possible by means of the selection window.

MSEQ2 100 The list currently set is marked in the selection window by means of the selection mark, here MSEQ2. In addition to the list name, the length of the list is given, here 100 elements.

2.2.12.2 Deletion of Lists - DELETE LIST

DELETE LIST opens a selection window in which the list to be deleted can be selected. The lists are represented together with their name and their length (cf. Fig. 2-9). By pressing the [RETURN] key the selection window is exited without deleting a list.

- Delete list
- Mark desired list using the rotary knob.
 - Press [SELECT] key.
The prompt "enter [SELECT] to delete list/sequence?" is displayed
 - Press [SELECT] key.
The list is deleted. If the prompt is acknowledged with the [RETURN] key, however, the list is not deleted. The selection window is automatically closed due to the acknowledgment of the prompt.

Selection: DELETE LIST

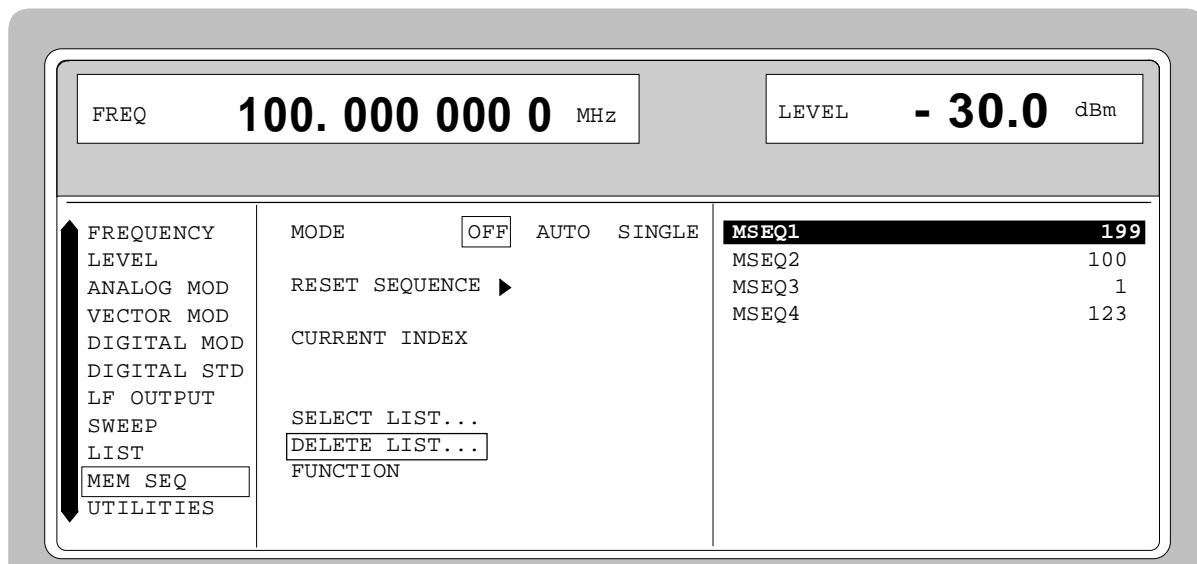

Fig. 2-9 DELETE-LIST selection window

2.2.11.3 Edition of Lists

Due to the selection of an edit mode on the OPERATION page the EDIT page is automatically activated. When the EDIT/VIEW function is selected, the largest possible section of the list is displayed (cf. Fig. 2-10). In the case of block functions FILL, INSERT and DELETE, an input window is additionally displayed (cf. Fig. 2-11 to 2-13).

Functions SELECT LIST and FUNCTION are available on the EDIT page as on the OPERATION page. Return to the OPERATION page is effected by pressing the [SELECT] key twice.

Single-value function EDIT/VIEW

By selecting the EDIT/VIEW function, the entire list can be viewed or modifications of single values be carried out.

If the cursor marks a value in the INDEX column of the list, the EDIT mode is exited by pressing the [RETURN] key. The menu cursor then marks FUNCTION again.

There is no separate function for storing the list. This means that every modification of the list is transferred to the internal data set and has an effect on exiting the EDIT/VIEW function.

Menu selection: FUNCTION EDIT/VIEW

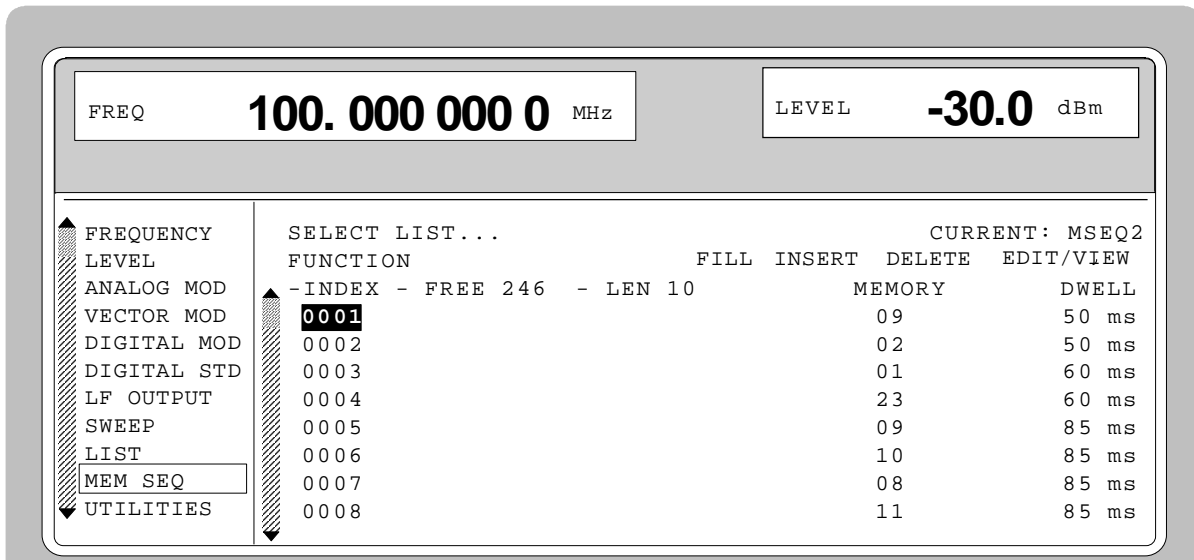

Fig. 2-10 Edit function EDIT/VIEW

- INDEX** Position in the list
- FREE** Space available. FREE 256 means that space for 256 parameter elements is available in the list memory in total.
- LEN** Occupied space. LEN 0 means that the current list occupies 0 elements in the list memory.
- MEMORY DWELL** Identification of the column below. The number and name of parameter columns is different for the various list editors.

- Select parameters
- Mark the index associated to the parameter using the rotary knob or directly enter the value of the index via the numeric keys.
 - Press [SELECT] key.
Parameter MEMORY is marked. If the second parameter DWELL is to be marked, press the [SELECT] key again.
- Modify parameters
- Vary the value of the parameter selected using the rotary knob or enter the value directly using numeric keys.

Note: The binary data of the digital modulations which cannot be varied are an exception. Further, all numeric keys except for "0" and "1" are ineffective in these cases.
 - Press the [ENTER] key or unit keys.
The value is included in the data set. The menu cursor marks the value of the next column. In the last column, the menu cursor then marks the next line of column MEMORY.
 - Press the [RETURN] key.
The menu cursor wraps back to the INDEX column. The EDIT mode is exited by repeatedly pressing the [RETURN] key (cf. Section 2.2.11.4).

Block function FILL

Using function FILL, a parameter, e.g. MEMORY, is overwritten with constant or linearly increasing/decreasing values within a defined range. The input window is exited by pressing the [RETURN] key without a modification being carried out.

If the filler range exceeds the end of the list, the list is automatically extended.

The list entry, in the example for MEMORY, with index [AT +n] is calculated as follows from the information AT, RANGE, starting value (MEMORY) and WITH INCREMENT:

$$\text{MEMORY[AT+n]} = \text{starting value (MEMORY)} + n \cdot \text{increment} \quad | \quad (0 \leq n \leq \text{RANGE1})$$

Selection: FUNCTION-FILL

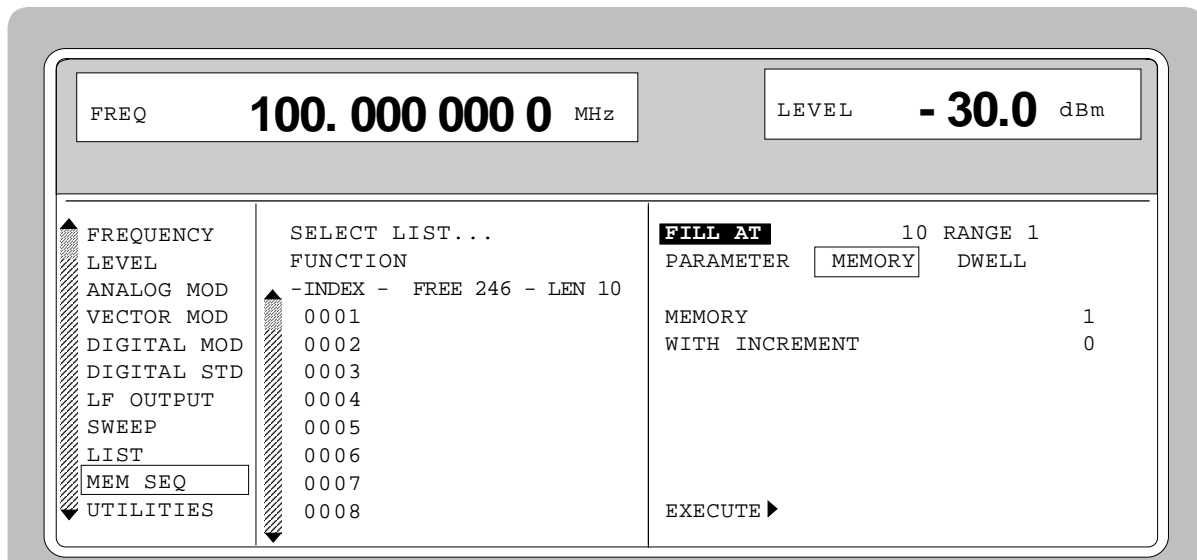

Fig. 2-11 Block function FILL: Input window

FILL AT	Setting the filling range. AT Lower limit (index) RANGE Number of the elements to be inserted
PARAMETER	Selection on which of the parameters the filling function is to have an effect. This menu option is eliminated if the list only includes elements with one parameter.
MEMORY or DWELL	Input of the starting value for the parameter selected. This option is only displayed if a selection has been made under PARAMETER MEMORY or DWELL.
WITH INCREMENT	Input of the increment between two successive values. If 0 is entered as increment, a filling procedure with constant values is achieved. This option is only displayed if a selection has been made under PARAMETER MEMORY or DWELL. <i>Note: In the case of some types of lists, e.g. digital modulation data, indicating an increment is eliminated since there are binary data. In these cases line WITH INCREMENT is eliminated.</i>
EXECUTE ►	Starts the filling sequence. After the function has been executed, the input window is automatically exited. The current index points to the first element after the processed range.
Filling a list	After selection of function FILL, the menu cursor marks FILL AT. <ul style="list-style-type: none"> ➤ Press the [SELECT] key. The menu cursor marks the value at AT. ➤ Vary index value using the rotary knob or enter using the numeric keys and the [ENTER] key. ➤ Press the [SELECT] key. The menu cursor marks the value at RANGE. ➤ Vary value using the rotary knob or enter using the numeric keys and the [ENTER] key. ➤ Press the [SELECT] key. The menu cursor marks MEMORY or DWELL in input line PARAMETER. ➤ Select MEMORY using the rotary knob (if not yet marked) and press the [SELECT] key. The menu cursor marks the value in input line MEMORY. ➤ Vary starting value for column MEMORY using the rotary knob or enter using the numeric keys and the [ENTER] key. ➤ Press the [SELECT] key The menu cursor marks the value in input line WITH INCREMENT. ➤ Vary the value of the increment desired using the rotary knob or enter using the numeric keys and the [ENTER] key. ➤ Press the [RETURN] key. ➤ Mark the action EXECUTE ► ➤ Press the [SELECT] key. The filling sequence is initiated. After the function has been carried out, the input window is automatically exited. The menu cursor marks FUNCTION. The EDIT page shows the end of the range that has been filled right now.

Block function INSERT

Function INSERT inserts the desired number of elements with constant or linearly increasing/decreasing values before the element with the given starting index. All elements which had been stored from the starting index are shifted to the end of the range to be inserted.

Input is effected analogously to filling a list.

By pressing the [RETURN] key the input window is exited without a modification being effected. The menu cursor then marks FUNCTION.

The list entry, in the example for MEMORY, with index [AT +n] is calculated as follows from the information AT, RANGE, starting value (MEMORY) and WITH INCREMENT:

$$\text{MEMORY[AT+n]} = \text{starting value (MEMORY)} + n \cdot \text{Increment} \quad | \quad (0 \leq n \leq \text{RANGE}-1)$$

Selection: FUNCTION INSERT

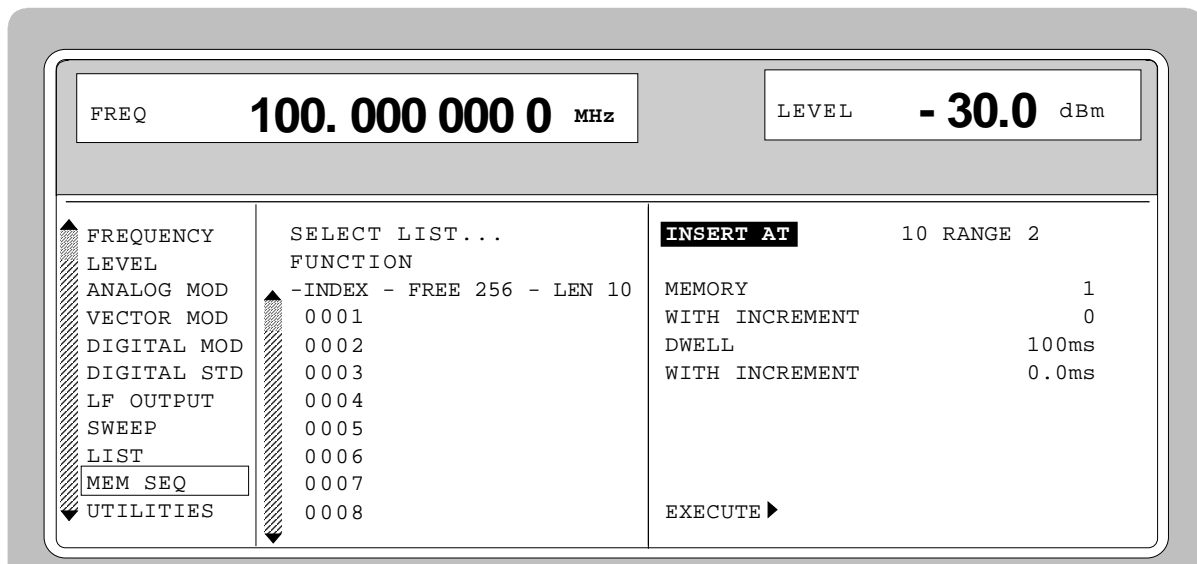

Fig. 2-12 Edit function INSERT: Input window

INSERT AT Input of the starting index and the number of the elements to be inserted.
 AT Starting index before which the insert operation is to be effective.
 RANGE Number of the elements to be inserted

MEMORY Input of the starting value for MEMORY.

DWELL Input of the starting value for DWELL.

WITH INCREMENT Input of the increment between two successive values for MEMORY or DWELL. If 0 is indicated as increment, constant values are achieved to be inserted RANGE times.

Note: In the case of some types of lists, e.g. digital modulation data, indicating an increment is eliminated since there are binary data. In these cases all lines WITH INCREMENT are eliminated.

EXECUTE ► Starts the inserting sequence. After the function has been executed, the input window is automatically exited. The menu cursor marks FUNCTION. The EDIT page shows the beginning of the range that has moved forward.

Block function DELETE

Function DELETE deletes the elements of the range indicated. This does not leave a gap in the list but the remaining elements move forward. If the given range exceeds the end of the list, deletion until the end of the list is effected.

Input is analog to filling a list.

By pressing the [RETURN] key, the input window is exited without a modification being carried out. The menu cursor then marks FUNCTION.

Selection: Function DELETE

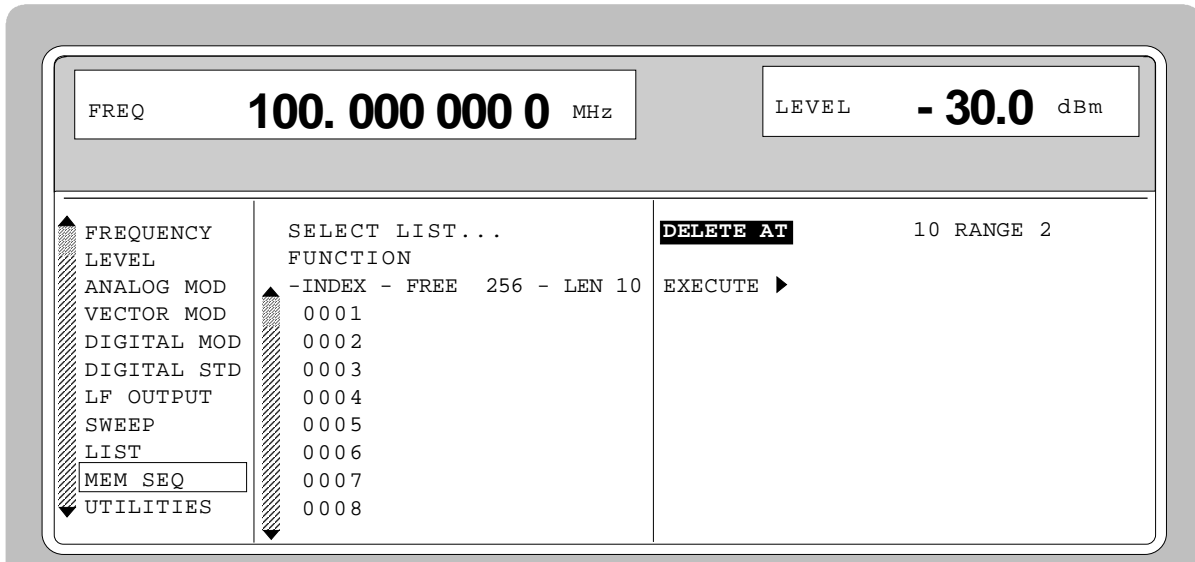

Fig. 2-13 Edit function DELETE: Input window

DELETE AT Input of the block of the list to be deleted
 AT Lower limit (INDEX)
 RANGE Number of elements to be deleted.

EXECUTE ► Starts the deletion. After the function has been executed, the input window is automatically exited. The menu cursor marks FUNCTION. The EDIT page shows the beginning of the range that has moved forward.

2.2.11.4 Pattern Setting to Operate the List Editor

The user can become familiar with the operation of the list editor by means of the following pattern setting in the MEM SEQ menu. A list has to be generated and filled with values by using the single-value function EDIT/VIEW:

- Memory location number of the first element 20
- Dwell time of the first element 15 s
- Memory location number of the second element 7.

When the setting has been terminated, return to the OPERATION page of the MEM SEQ menu.

At the beginning of the operation sequence, menu MEM SEQ is called. First a list MSEQ0 has to be generated and then activated. The menu cursor marks a parameter of the setting menu on the OPERATION page (c.f. Fig. 2-14).

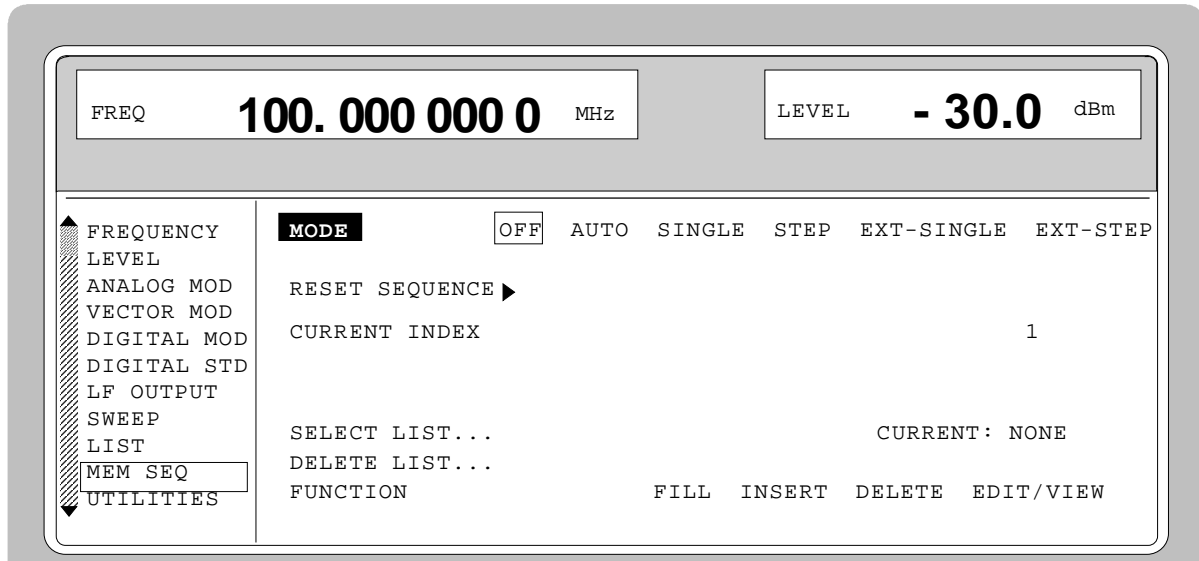
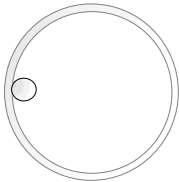









Fig. 2-14 Starting point of the pattern setting

Operating steps		Explanations
MENU / VARIATION	MENU / VARIATION	Select the SELECT LIST menu item.
	<p>SELECT LIST...</p> <p>SELECT</p>	
MENU / VARIATION	MENU / VARIATION	A new list MSEQ0 is generated. The menu cursor is reset to SELECT LIST...
	<p>CREATE NEW LIST ▶</p> <p>SELECT</p>	
MENU / VARIATION	MENU / VARIATION	Select the FUNCTION menu item.
	<p>FUNCTION...</p> <p>SELECT</p>	

Operating steps	Explanations
<p>MENU / VARIATION</p>  <p>.EDIT VIEW.</p> <p>MENU / VARIATION</p> 	<p>Select single-value function EDIT/VIEW.</p> <p>The EDIT page of the MEM SEQ menu is called. The menu cursor marks the index of the first element of list MSEQ0.</p>
	<p>Set the menu cursor to the memory location number value of the first element (c.f. Fig. 2-15,A).</p>
<p>DATA INPUT</p> 	<p>Enter MEMORY 20.</p> <p>The menu cursor automatically wraps to the DWELL value of the first element (Fig. 2-15,B). The default value is 100 ms.</p>
<p>DATA INPUT</p> 	<p>Enter DWELL 15 s.</p> <p>The menu cursor automatically wraps to the MEMORY value of the second element.</p>
<p>DATA INPUT</p> 	<p>Enter MEMORY 7.</p> <p>The menu cursor automatically wraps to the DWELL value of the second element (default value is 100 ms).</p>
	<p>Reset the menu cursor to the index.</p>
	<p>Reset the menu cursor to the FUNCTION menu item of the EDIT page of menu MEM SEQ (c.f. Fig. 2-15,C).</p>
	<p>Reset the menu cursor to the FUNCTION menu item of the OPERATION page of menu MEM SEQ.</p>

Note: With the return to the OPERATION page the operation of the list editor is finished. In the list mode (menu LIST), function LEARN ► must be activated subsequently to ensure that the settings are transferred to the hardware

A

FREQ **100.000 000 0** MHz LEVEL **- 30.0** dBm

FREQUENCY	FUNCTION	FILL	INSERT	DELETE	EDIT/VIEW
LEVEL	-INDEX - FREE 0246 - LEN 0010				
ANALOG MOD	0001				
VECTOR MOD					
DIGITAL MOD					
DIGITAL STD					
LF OUTPUT					
SWEEP					
LIST					
MEM SEQ					
UTILITIES					

CURRENT: MSEQ0

B

FREQ **100.000 000 0** MHz LEVEL **- 30.0** dBm

FREQUENCY	FUNCTION	FILL	INSERT	DELETE	EDIT/VIEW
LEVEL	-INDEX - FREE 0246 - LEN 0010				
ANALOG MOD	0001				
VECTOR MOD		20			100 ms
DIGITAL MOD	0002				
DIGITAL STD					
LF OUTPUT					
SWEEP					
LIST					
MEM SEQ					
UTILITIES					

CURRENT: MSEQ0

C

FREQ **100.000 000 0** MHz LEVEL **- 30.0** dBm



FREQUENCY	FUNCTION	FILL	INSERT	DELETE	EDIT/VIEW
LEVEL	-INDEX - FREE 0246 - LEN 0010				
ANALOG MOD	0001				
VECTOR MOD		20			15.00 s
DIGITAL MOD	0002				
DIGITAL STD		07			100 ms
LF OUTPUT	0003				
SWEEP					
LIST					
MEM SEQ					
UTILITIES					

CURRENT: MSEQ0

Fig. 2-15, a to c Pattern setting - Edition of a list

2.2.12 Save/Recall - Storing/Calling of Instrument Settings

50 complete instrument settings can be stored in memory locations 1 to 50.

Operating steps	Explanations
<p style="text-align: center;">DATA INPUT</p>  <p>The diagram shows a sequence of four buttons: a rectangular button labeled 'SAVE', followed by two square buttons labeled '1' and '2', and finally a rectangular button labeled 'x1 ENTER'.</p>	<p>Store current instrument setting in memory location 12.</p>
<p style="text-align: center;">DATA INPUT</p>  <p>The diagram shows a sequence of four buttons: a rectangular button labeled 'RCL', followed by two square buttons labeled '1' and '2', and finally a rectangular button labeled 'x1 ENTER'.</p>	<p>Call instrument setting of memory location 12.</p>

The digital display during a save or recall entry is faded in a window.

Memory location 0 has a special function. Here the instrument setting which was current prior to the last memory recall and prior to a preset setting is automatically stored. This permits the resetting of instrument settings which have inadvertently been deleted using Recall 0.

If an instrument setting is stored in which a sweep was switched on, the sweep is started using the recall.

The parameter EXCLUDE FROM RCL in the FREQUENCY and LEVEL-LEVEL menus determines whether the saved RF frequency and RF level are loaded when an instrument setting is loaded, or whether the current settings are maintained.

Store IEC-bus command: `**SAV 12"`

Recall IEC-bus command: `**RCL 12"`

Notes: - The contents of lists, as they are used for the Memory Sequence (MSEQ) or for user correction (UCOR), is not saved in the SAVE memory. It is stored under the respective list name and can be called. If instrument settings are called which go back to list data such as level setting using UCOR, the current list contents is used. If this has been altered, it is not identical to the list contents at the point of storing any more.

- The frame configurations (digital standards PHS, NADC, PDC, GSM, DECT) and the channel configurations (digital standards CDMA, W-CDMA, 3GPP W-CDMA) are not stored in the SAVE memory either. These settings can be stored and loaded via menu items SAVE/RCL FRAME and SAVE/RCL MAPPING in the corresponding DIGITAL STD menus.
- The instruments comprise the "Fast Restore" mode for very fast loading of stored device settings. This mode can be called up only during remote control (see section 3, "Fast Restore Mode").

2.3 Menu Summary

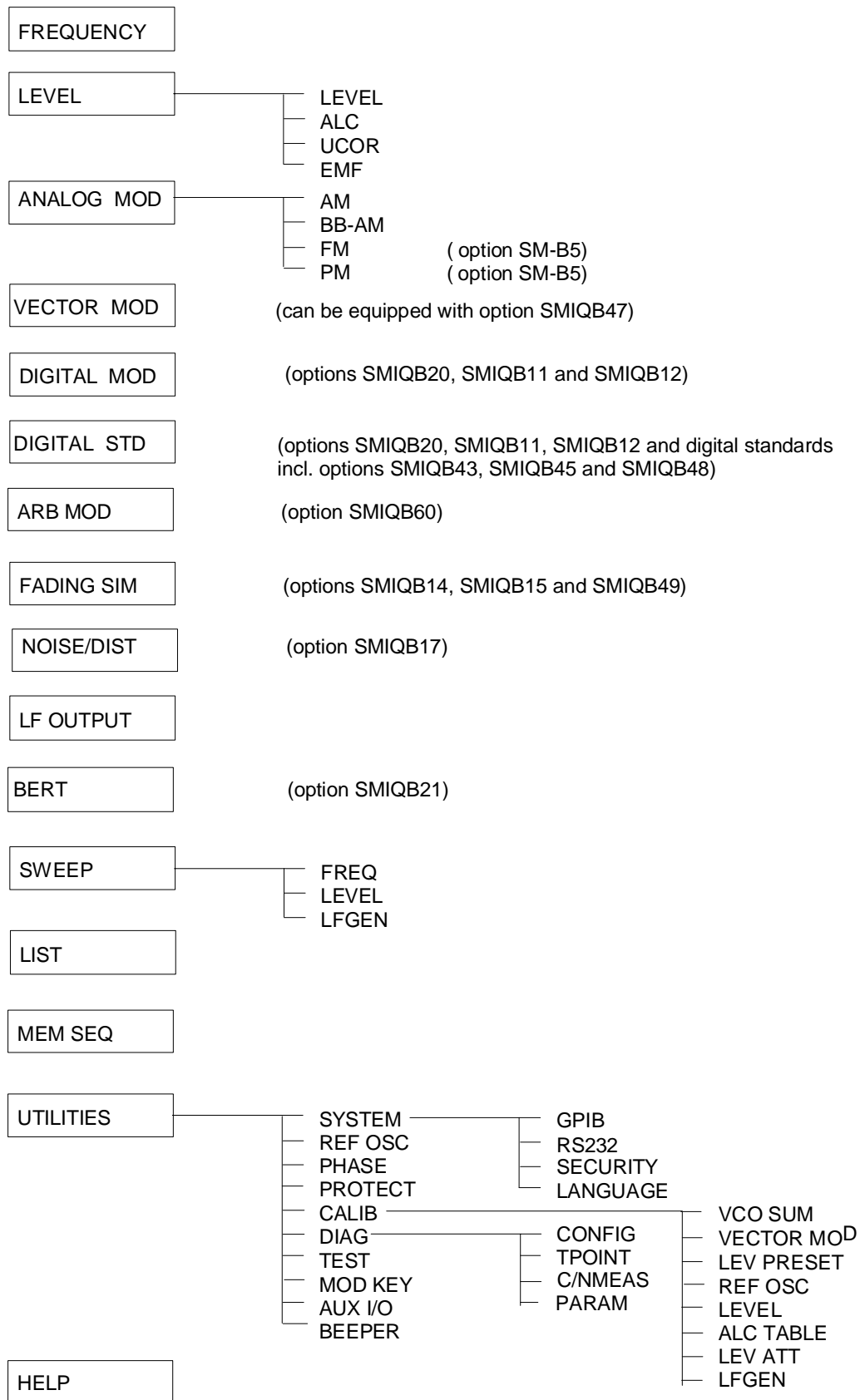

2.4 RF Frequency

The RF frequency can be set directly using the [FREQ] key (cf. Section 2.2.6) or by accessing menu FREQUENCY.

The frequency of the RF output signal is entered/indicated under FREQUENCY in the FREQUENCY menu.

The input value of frequency settings opened by means of the [FREQ] key and indicated in the header line considers the offset in calculation (cf. next Section). This offers the possibility of entering the desired output frequency of possibly series-connected instruments such as mixers in the menu.

<i>Note:</i>	<i>Further settings:</i>	<i>Frequency sweep</i>	<i>Menu SWEEP</i>
		<i>LF frequency</i>	<i>Menu ANALOG MOD</i>
			<i>Menu LF-OUTPUT</i>
		<i>Int./ext. reference frequency</i>	<i>Menu UTILITIES-REF OSC</i>
		<i>Phase of the output signal</i>	<i>Menu UTILITIES-PHASE</i>

Menu selection: FREQUENCY

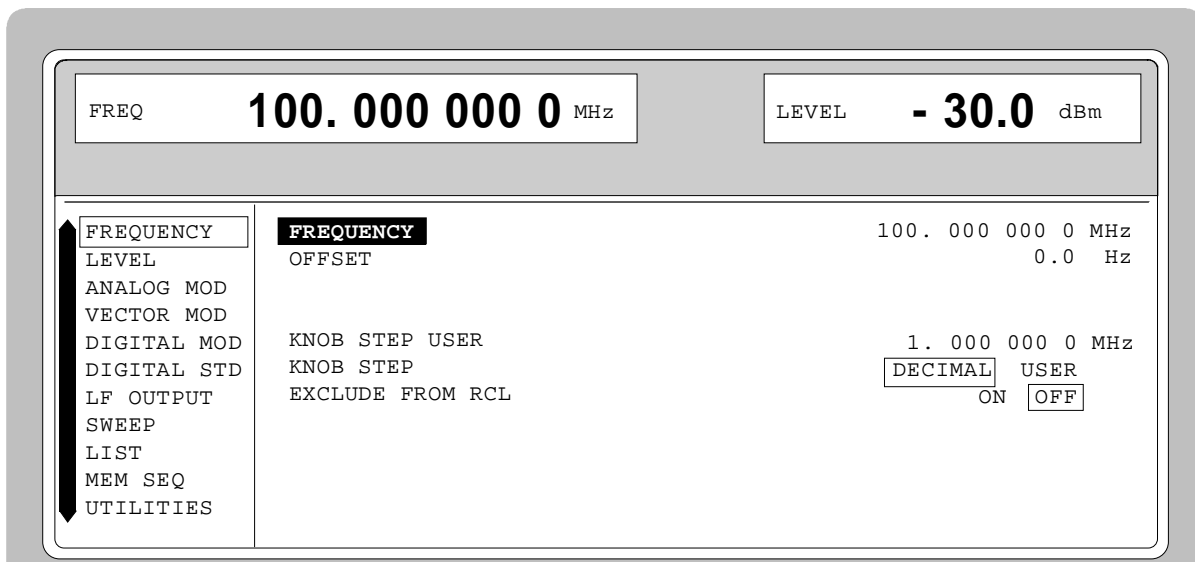

Fig. 2-16 Menu FREQUENCY (preset setting)

FREQUENCY	Input value of the RF frequency at the RF output connector. IEC/IEEE-bus command <code>SOUR:FREQ 100E6</code>
OFFSET	Input value of the frequency offset, e.g., of a series-connected mixer (cf. Section "Frequency Offset"). The status line indicates FREQ-OFFST. IEC/IEEE-bus command <code>SOUR:FREQ:OFFS 0</code>
KNOB STEP USER	Input value of the step width for frequency variation using the rotary knob. The RF frequency is varied in the step width entered if KNOB STEP is set to USER. IEC/IEEE-bus command <code>SOUR:FREQ:STEP 1MHz</code>
KNOB STEP	DECIMAL: Variation step width corresponding to the position of the digit cursor. USER: "User Defined", variation step width as entered under KNOB STEP USER .

EXCLUDE FROM RCL	OFF	The saved frequency is also loaded when instrument settings are loaded with the [RCL] key or with a memory sequence. IEC/IEEE-bus command <code>SOUR:FREQ:RCL INCL</code>
	ON	The RF frequency is not loaded when instrument settings are loaded, the current frequency is maintained. IEC/IEEE-bus command <code>SOUR:FREQ:RCL EXCL</code>

2.4.1 Frequency Offset

The SMIQ offers the possibility of entering an offset (OFFSET) of possibly series-connected instruments in the FREQUENCY menu. The indication/input value of FREQ in the header field considers this input and represents the frequency value of the RF signal at the output of these instruments (cf. Fig. 2-17).

The entry values FREQUENCY and OFFSET in the menu FREQUENCY or FREQ in the header line are related to the RF output frequency as follows :

$$\text{FREQ} - \text{OFFSET} = \text{output frequency} (= \text{FREQUENCY}).$$

An offset entry causes no modification of the RF output frequency but only a modification of the display value in the FREQ field in the header line, ie FREQ in the header line indicates the offset-associated frequency and FREQUENCY in the menu FREQUENCY the RF output frequency. The status line indicates FREQ-OFFST.

The offset setting also remains effective with the frequency sweep.

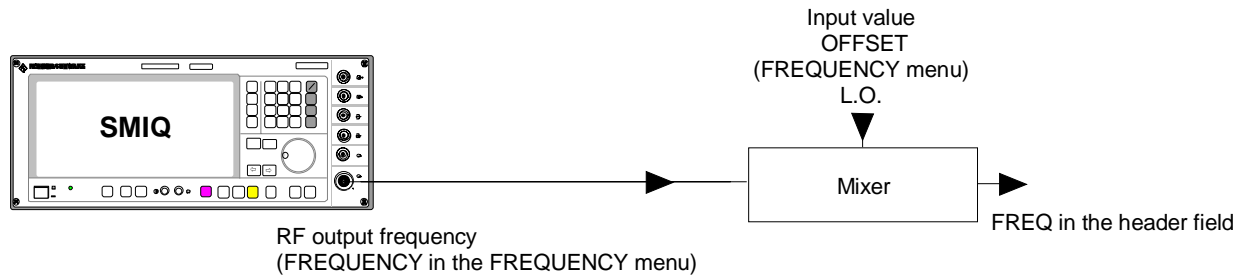

Fig. 2-17 Example of a circuit with frequency offset

2.5 RF Level

The RF level can be set directly using the [LEVEL] key (cf. Section 2.2.6) or by accessing the LEVEL menu.

In the LEVEL-LEVEL menu, the set RF output level is indicated under AMPLITUDE. A two-line level display appears for digital modulation or digital standard. The upper line indicates the average power (LEVEL), the lower line the peak envelope power (PEP) of the modulated RF output signal.

The input value of level settings effected in the LEVEL-LEVEL menu directly corresponds to the RF output level.

The input value of the level settings opened using the [LEVEL] key mathematically considers the offset of an attenuation/amplification element which is possibly series-connected (cf. Section 2.5.1). This offers the possibility of entering the desired level at the output of series-connected instruments, the SMIQ then alters the RF output level correspondingly. The offset can also be entered in the LEVEL-LEVEL menu.

dBm, dB μ V, mV and μ V can be used as level units. The 4 unit keys are directly labeled with these units. In order to change to another level unit, simply press the desired unit key.

- Notes:**
- The message *ERROR* is displayed in the status line if the level set in the overrange is not reached.
 - For digital modulation or digital standard, a *WARNING* message appears in the status line if the set *LEVEL* or the displayed *PEP* are overranged. If the set level cannot be generated as an overrange value, *ERROR* will be displayed.
 - Further settings: Level sweep menu *SWEEP*

Menu selection: LEVEL - LEVEL

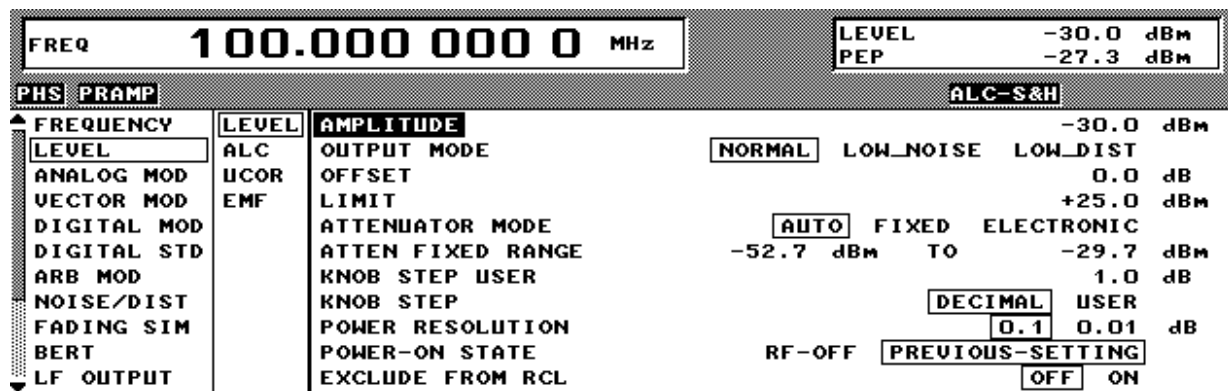

Fig. 2-18 Menu LEVEL (preset setting) POWER RESOLUTION is set to 0.01 dB

AMPLITUDE Input value of the RF level at the RF output connector.
IEC/IEEE-bus command SOUR:POW -30

OFFSET	<p>Input value of the level offset of the RF output level compared to the input value of the RF level indicated in the LEVEL header field. Input in dB (cf. Section 2.5.1, Level Offset). The status line indicates LEV-OFFST.</p> <p>IEC/IEEE-bus command SOUR:POW:OFFS 0</p>
LIMIT	<p>Input value of level limitation. This value indicates the upper limit of the level at the RF output connector. If a level above this limit is attempted to be set, a warning is displayed in the status line.</p> <p>IEC/IEEE-bus command SOUR:POW:LIM 16 dBm</p>
ATTENUATOR MODE	<p>AUTO Normal operation. The attenuator switching mechanically switches in steps of 5 dB, the switching points being fixed.</p> <p>IEC/IEEE-bus command :OUTP:AMOD AUTO</p> <p>FIXED Level settings are made in a range of somewhat over 20 dB without switching the attenuator (see section 2.5.2, "Non-interrupting Level Setting"). The range of variation is fixed automatically upon selection of this operating mode. The range is indicated in the ATTEN FIXED RANGE menu. With level settings out of the indicated range, a warning is displayed.</p> <p>IEC/IEEE-bus command :OUTP:AMOD FIX</p> <p>ELECTRONIC</p> <p>Level settings are made in a range of somewhat over 90 dB without switching the attenuator (see section 2.5.2, "Non-interrupting Level Setting"). The range of variation is fixed automatically upon selection of this operating mode. The range is indicated in the ATTEN FIXED RANGE menu. With level settings out of the indicated range, a warning is displayed.</p> <p>This function is only available if the IQMOD module of version VAR 4 or higher is installed (indication in UTILITIES - DIAG - CONFIG menu, IQMOD Var 4 required).</p> <p>IEC/IEEE-bus command :OUTP:AMOD ELEC</p>
ATTEN FIXED RANGE	<p>Indication of the level range in which the level is set without interruption in the "ATTENUATOR MODE FIXED" operating mode.</p>
KNOB STEP USER	<p>Input value of the step width for level variation using the rotary knob. The RF level is varied in the step width entered if KNOB STEP is set to USER.</p> <p>IEC/IEEE-bus command SOUR:POW:STEP 1</p>
KNOB STEP	<p>DECIMAL Variation step width according to the position of the digit cursor.</p> <p>USER User Defined, variation step width as entered under KNOB STEP USER.</p>
POWER RESOLUTION	<p>Selection of resolution of LEVEL display. For level range -99.9 dBm to +16 dBm the resolution for the level display can be set to 0.1 dB or 0.01 dB.</p>
POWER-ON STATE	<p>Selection of the state the RF output is to assume after power-on of the unit</p> <p>RF OFF Output is switched off</p> <p>PREVIOUS SETTING Same state as before switch-off</p> <p>IEC/IEEE-bus command :OUTP:PON ON</p>

EXCLUDE FROM RCL	OFF	The saved RF level is also loaded when instrument settings are loaded with the [RCL] key or with a memory sequence. IEC/IEEE-bus command <code>SOUR:POW:RCL INCL</code>
	ON	The RF level is not loaded when instrument settings are loaded, the current level is maintained. IEC/IEEE-bus command <code>SOUR:POW:RCL EXCL</code>

2.5.1 Level Offset

The SMIQ offers the possibility of entering the offset (OFFSET) of a possibly series-connected attenuator/amplification element in the LEVEL-LEVEL menu. The indication/input value in the LEVEL header field considers this input (see below) and represents the level value of the signal at the output of the series-connected instrument (cf. Fig. 2-19).

The entry values AMPLITUDE and OFFSET in the menu LEVEL or LEVEL in the header line are related to the RF output level as follows:

$$\text{LEVEL} - \text{OFFSET} = \text{output level} (= \text{AMPLITUDE})$$

An offset entry causes no modification of the RF output frequency but only a modification of the display value in the LEVEL field in the header line, ie LEVEL in the header line indicates the offset-associated level and AMPLITUDE in the menu LEVEL the RF output level. The status line indicates LEV-OFFST. The offset is to be entered in dB.

The offset setting also remains effective in the ATTENUATOR MODE FIXED operating mode and with level sweep.

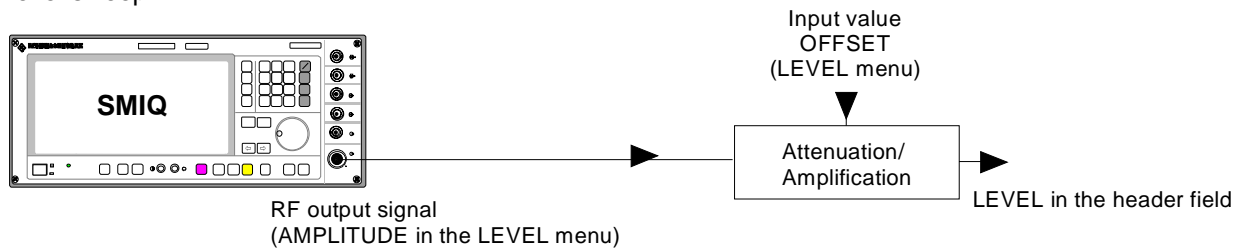

Fig. 2-19 Example of a circuit with level offset

2.5.2 Interrupt-free Level Setting

In the ATTENUATOR MODE FIXED and ATTENUATOR MODE ELECTRONIC operating modes, level settings are carried out without interruption. The attenuator is switched electronically rather than mechanically.

The MODE FIXED variation range is somewhat over 20 dB, the variation range of MODE ELECTRONIC over 90 dB. In case of over- or underranging of the normal variation range, level errors strongly increase and an under/overrange warning is displayed. At high attenuation values the spectral purity of the output signal is degraded.

The ATTENUATOR MODE ELECTRONIC mode is only possible with level control switched off. The ALC OFF mode is automatically set to TABLE.

Note: *To ensure highest level accuracy in ATTENUATOR MODE ELECTRONIC mode, the self calibration routines ALC TABLE and LEV ATT should be called up in the UTILITIES - CALIB menu after temperature variations of more than 5 degrees.*

The MODE ELECTRONIC cannot be used either simultaneously with the SLOT ATTENUATION function of the digital standards. This applies to all TDMA standards. The MODE ELECTRONIC cannot be used either simultaneously with the DIGITAL MOD - POWER RAMP CONTROL - ATTENUATION function.

2.5.3 Switching On/Off Internal Level Control

The LEVEL - ALC menu allows the level control to be switched on and off for special applications. In the normal operating mode for CW, AM and FM(PM), level control is switched on so that an optimum level accuracy is obtained. For vector modulation or digital modulation, level control must normally be off. In this case the SAMPLE&HOLD or the TABLE mode can be selected instead.

In the SAMPLE&HOLD mode the level is recalibrated after each level or frequency setting. To do this, CW is selected for a short period of time, level control is switched on and the level control held at the value attained. If this calibration procedure is not desired, the TABLE mode (level control voltage taken from a table) can be selected. In this mode the correction values required after a frequency or level change are obtained from a table. With the LEARN TABLE ► function called up, a new table can be prepared without any additional measuring instruments being required.

The preset level control is AUTO. Level control in this mode is automatically adapted to the operating conditions. For special applications, level control can be held in the OFF or ON state. Level control OFF is useful for improving the intermodulation suppression in multi-signal measurements in the CW mode. The ON setting is recommended if vector modulation or digital modulation with a constant envelope curve is required.

Menu selection: LEVEL - ALC

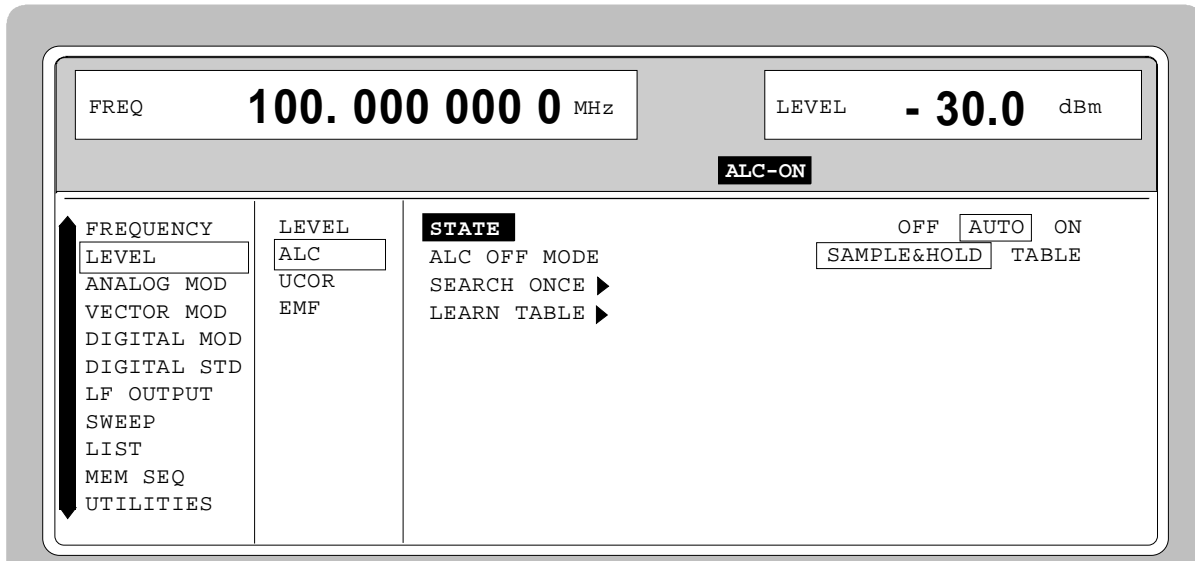

Fig. 2-20 Menu LEVEL - ALC (preset setting)

STATE	OFF	Internal level control is deactivated. In this state no AM is possible . IEC/IEEE-bus command SOUR:POW:ALC OFF
	AUTO	Normal state. The internal level control is automatically adjusted to the operating conditions. IEC/IEEE-bus command SOUR:POW:ALC AUTO
	ON	Internal level control is permanently switched on. IEC/IEEE-bus command SOUR:POW:ALC ON
ALC OFF MODE	SAMPLE&HOLD	Level recalibration in the ALC OFF mode after the level or frequency has been set. IEC/IEEE-bus command SOUR:POW:ALC:SEAR ON
	TABLE	In the ALC OFF mode correction values are taken from a table. IEC/IEEE-bus command SOUR:POW:ALC:SEAR OFF
SEARCH ONCE ►		Manual short-time switching on of the level control for level calibration in the ALC OFF and SAMPLE&HOLD operating mode. IEC/IEEE-bus command SOUR:POW:ALC:SEAR ONCE
LEARN TABLE ►		Correction values for the ALC OFF MODE-TABLE function are regenerated (level control voltage obtained from a table). IEC/IEEE-bus command SOUR:POW:ALC:TABL?

2.5.4 User Correction (UCOR)

Function "User Correction" can be used to create and activate lists in which arbitrary RF frequencies are assigned level correction values.

Up to 10 lists with a total of 160 correction values can be compiled. For frequencies which are not included in the list the level correction is determined by means of interpolation of the nearest correction values.

When user correction is switched on, the LEVEL indication is completed by the indication UCOR (User Correction) in the header field of the display. The RF output level is the sum of both values.

$$\text{LEVEL} + \text{UCOR} = \text{output level}$$

If the offset setting is used at the same time, the LEVEL indication value is the difference of the input values AMPLITUDE and OFFSET of the menu LEVEL.

$$\text{AMPLITUDE} - \text{OFFSET} = \text{LEVEL}$$

The user correction is effective in all operating modes if switched on.

Menu selection: LEVEL - UCOR

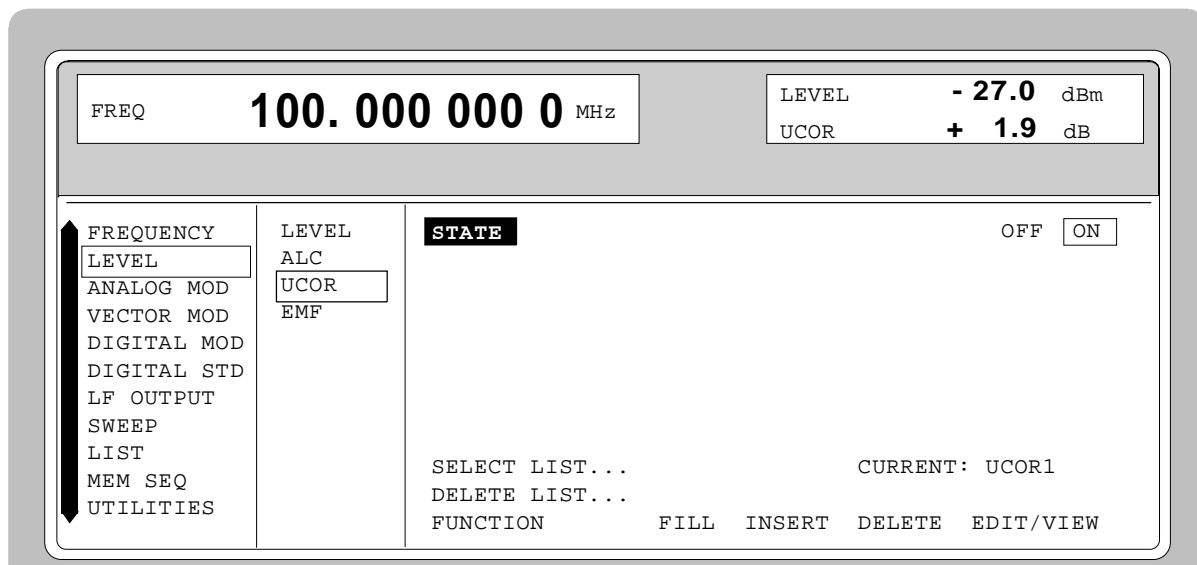

Fig. 2-21 Menu LEVEL - UCOR - OPERATION side

STATE	Switching on/off user correction. IEC/IEEE-bus command SOUR:CORR ON
SELECT LIST...	Selection of a list or generation of a new list (cf. Section 2.2.11, List Editor). IEC/IEEE-bus command SOUR:CORR:CSET "UCOR1"
DELETE LIST...	Deletion of a list (cf. Section 2.2.11, List Editor). IEC/IEEE-bus command SOUR:CORR:CSET:DEL "UCOR2"
FUNCTION	Selection of the editing mode to process the selected list (cf. Section 2.2.11, List Editor). IEC-bus commands SOUR:CORR:CSET:DATA:FREQ 100 MHz, 102 MHz, ... SOUR:CORR:CSET:DATA:POW 1dB, 0.8dB, ...

Menu selection: LEVEL - UCOR

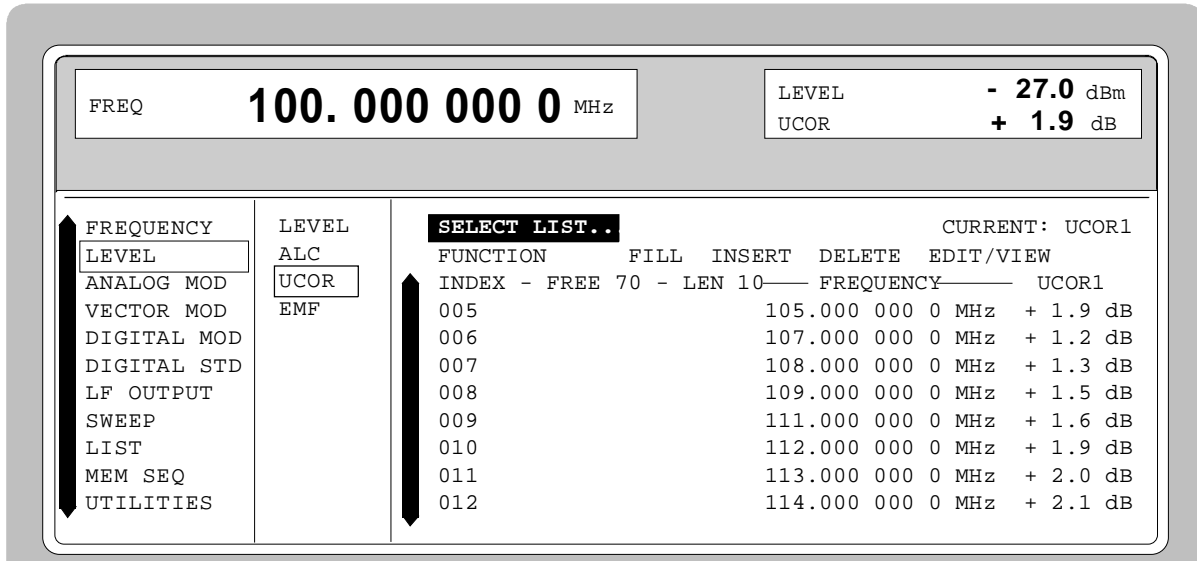

Fig. 2-22 Menu UCOR - LEVEL-EDIT side

2.5.5 EMF

The signal level can also be set and indicated as the voltage of EMF (open-circuit voltage).

EMF is displayed in the header field of the display after the unit of the level indication.

Menu selection: LEVEL - EMF

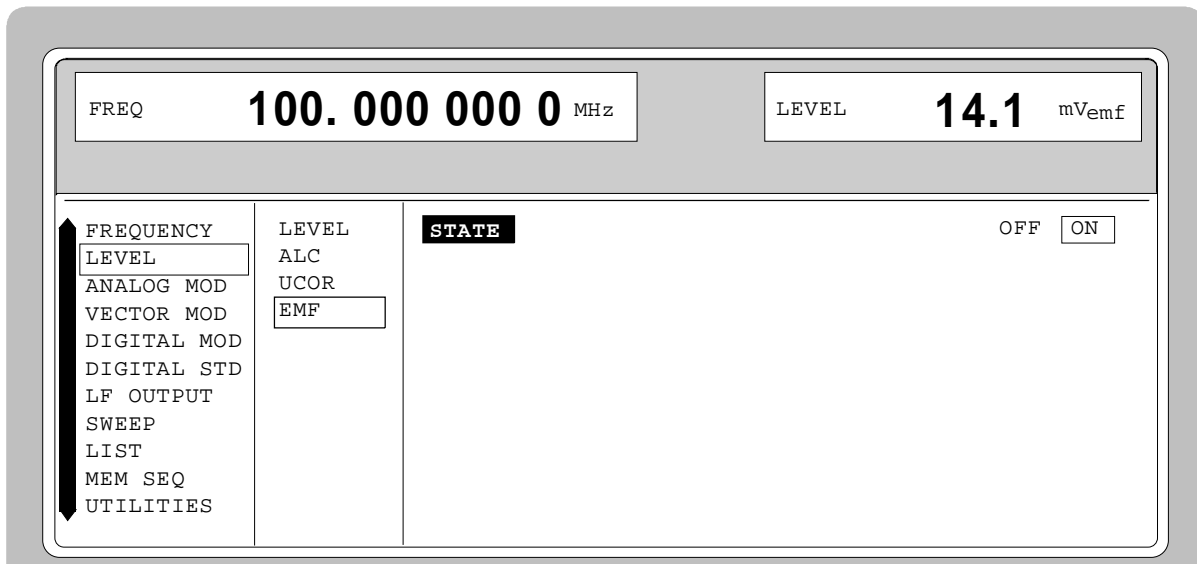

Fig. 2-23 Menu LEVEL-EMF

STATE ON Voltage value of the level is the voltage of EMF.
 OFF Voltage value of the level is voltage at 50 Ω (preset setting).

2.5.6 [RF ON / OFF]-Key

The RF output signal is switched on and off again using the [RF ON / OFF] key. This does not influence the current menu. When the output signal is switched off, the message "RF OFF" is displayed in the LEVEL indication of the header field. If RF OFF is displayed, the 50-Ω source resistance is maintained.

IEC/IEEE-bus command :OUTP OFF

2.5.7 Reset Overload Protection

The SMIQ is protected against overload by an external signal which is fed into the RF output. If an external signal is too high, the overload protection responds. This state is indicated by means of the message "RF OFF" in the LEVEL indication in the header field and the message "OVERLOAD" in the status line.

➤ Reset the overload protection by pressing the [RF ON / OFF] key.

IEC/IEEE-bus command :OUTP:PROT:CLE

2.6 Modulation - General

The SMIQ offers the following modulations and digital standards:

- Analog modulations
 - Amplitude modulation (AM)
 - Broadband AM (BB-AM)
 - Frequency modulation (FM; with option SM-B5 only)
 - Phase modulation (PM; with option SM-B5 only)
 - Pulse modulation (PULSE)
- Vector modulation (VECTOR MOD)
- Digital modulation (DIGITAL MOD; option SMIQB20)
- Digital standards (DIGITAL STD;-PHS; IS95/CDMA - option SMIQB42; NADC; PDC; GSM; DECT; W-CDMA - option SMIQB43; 3GPP W-CDMA - option SMIQB45; Enhanced Channels – option SMIQB48; options SMIQB20 and SMIQB11)

For AM, FM, PM and digital modulation internal or external modulation sources can be used.
For BB-AM, pulse and vector modulation only external modulation sources can be used.

2.6.1 Modulation Sources

Internal Modulation Sources

The internal modulation generator LF GEN is available for AM, FM and PM. The generator supplies sinusoidal signals in the frequency range from 0.1 Hz to 1 MHz. For a more detailed description, cf. Section "LF Generator".

The internal modulation coder (option SMIQB20) supplies PRBS signals, clock signals or modulation data for the digital modulations. The data generator (option SMIQB11) supplies modulation data and control signals. For a more detailed description, cf. Section "Digital Modulations".

External Modulation Sources

The appropriate input sockets to the different modulations in the case of external supply can be taken from Table 2-1.

Table 2-1 Input sockets for the different types of modulation

Modulation	Input									
	EXT1	EXT2	PULS	I	Q	DATA	PAR DATA	BIT CLOCK	SYMBOL CLOCK	POW RAMP
AM	X									
BB-AM				X						
FM1	X	X								
FM2	X	X								
PM1	X	X								
PM2	X	X								
PULSE			X							
VECTOR MOD				X	X					X
DIGITAL MOD						X	X	X	X	X

EXT1/EXT2-Inputs

The external modulation signal for AM, FM and PM at inputs EXT1 and EXT2 must show a voltage of $V_s = 1\text{ V}$ ($V_{\text{eff}} = 0.707\text{ V}$) in order to maintain the modulation depth or deviation indicated. A monitoring circuit checks the input voltage in the frequency range 10 Hz to 100 kHz. Deviations of more than $\pm 3\%$ are signaled in the status line by means of the following messages (cf. Table 2-2). The inputs EXT1 and EXT2 can be AC- or DC-coupled. Monitoring is only active if the inputs are AC-coupled.

Table 2-2 Status messages in the case of a deviation from the rated value at the external modulation inputs EXT1 and EXT2

Message	Deviation
EXT1-HIGH	Voltage at EXT1 too high
EXT1-LOW	Voltage at EXT1 too low
EXT2-HIGH	Voltage at EXT2 too high
EXT2-LOW	Voltage at EXT2 too low
EXT-HI/HI	Voltage at EXT1 and EXT2 too high
EXT-LO/LO	Voltage at EXT1 and EXT2 too low
EXT-HI/LO	Voltage at EXT1 too high and EXT2 too low
EXT-LO/HI	Voltage at EXT1 too low and EXT2 too high

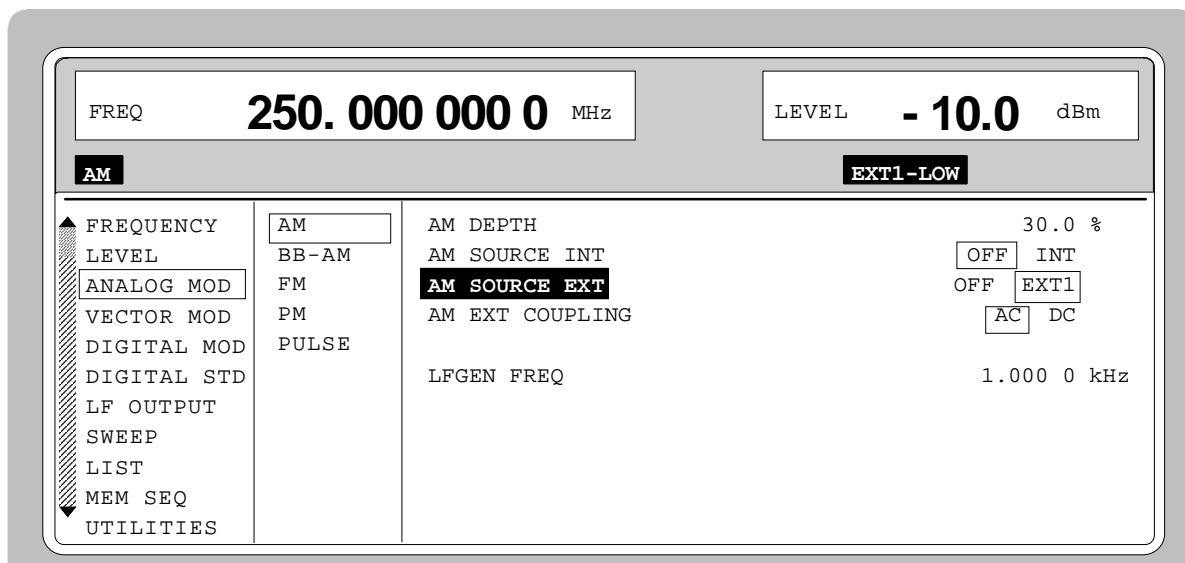

Fig. 2-24 Example: Status message "EXT1-LOW" in case of voltage at EXT1 too low

I/Q Inputs

The nominal voltage at the I/Q-inputs for external vector modulation is $U_s = 0.5\text{ V}$. Input resistance is 50 Ω . For a more detailed description, cf. Section "Vector Modulation".

For external broadband AM the I-input is used. Input sensitivity is 0,25 V for 100% AM.

2.6.2 LF Generator

The SMIQ is equipped with a LF-generator as internal modulation source as a standard. The generator supplies sinusoidal signals in the frequency range from 0.1 Hz to kHz.

The frequency settings of the internal modulation signals can be made in one of the modulation menus (AM, FM, PM) as well as in the LF-output menu. Figure 2-25 shows the setting parameters using the AM menu as an example.

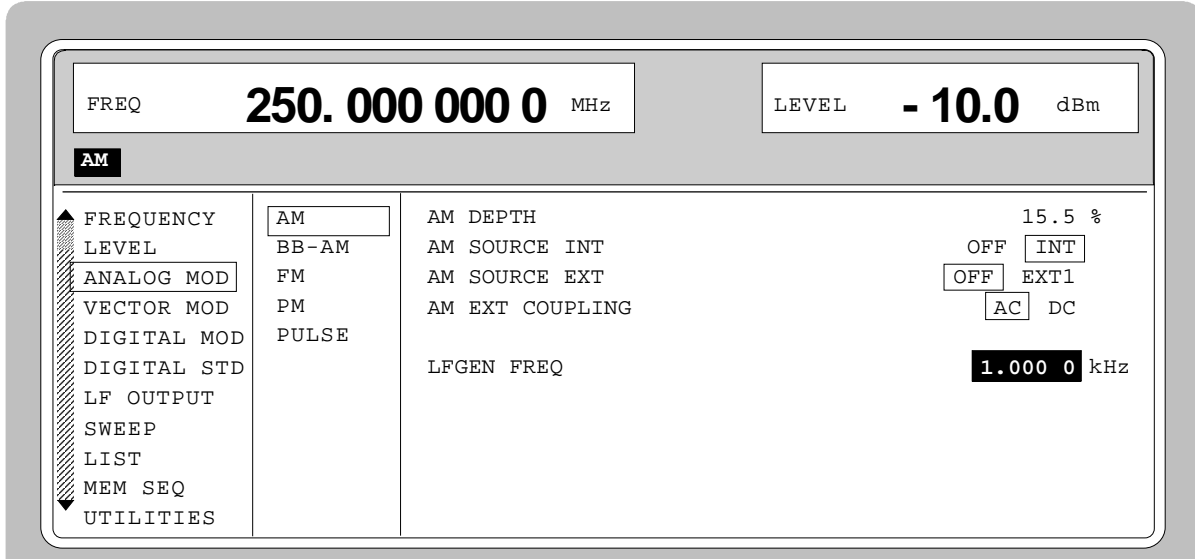

Fig. 2-25 Example: Settings of the LF generator in the AM menu

2.6.3 Simultaneous Modulation

Combination of AM and FM as well as AM and vector modulation is possible. Instead of FM, phase modulation (PM) can be switched on as well.

Two-tone AM is possible by simultaneously switching on the external and internal source.

Two-tone FM or two-tone PM is possible by simultaneously switching on FM1 and FM2 or PM1 and PM2. For FM1 and FM2 (PM1 and PM2) separate deviations can be set and separate sources switched on.

Note: *With two-tone modulation please observe that the set deviation or modulation depth is valid for one signal and the sum deviation or sum modulation depth is determined by adding both signals. This results in overmodulation if the maximal value for deviation or modulation depth is exceeded.*

2.6.4 [MOD ON/OFF] Key

The modulations can directly be switched on/off using the key or by accessing the modulation menus. When switching on using the [MOD ON/OFF] key, the modulation sources which are set in the modulation menus are used.

The [MOD ON/OFF] key can either be effective for all modulations or for a selected modulation. The selection for which modulation the [MOD ON/OFF] key is effective is made in the UTILITIES-MOD KEY menu (cf. Section "Assigning Modulation to [MOD ON/OFF] Key").

When selecting a certain type of modulation, each pressing the [MOD ON/OFF] key switches on or off the modulation selected.

In the case of selection "all modulations", the [MOD ON/OFF] key has the following effect:

- At least one modulation is active:
Pressing the [MOD ON/OFF] key switches off all active modulations. Which modulations were active is stored.
- No modulation is active:
Pressing the [MOD ON/OFF] key switches on the modulations which were last switched off using the [MOD ON/OFF] key.

2.7 Analog Modulations

2.7.1 Amplitude Modulation

Menu ANALOG MOD-AM offers access to settings for amplitude modulation.

- Notes:**
- The specifications for AM are only valid for the specified Level (PEP) range.
 - For AM, setting LEVEL-ALC-STATE ON or AUTO is recommended.

Menu selection: ANALOG MOD - AM

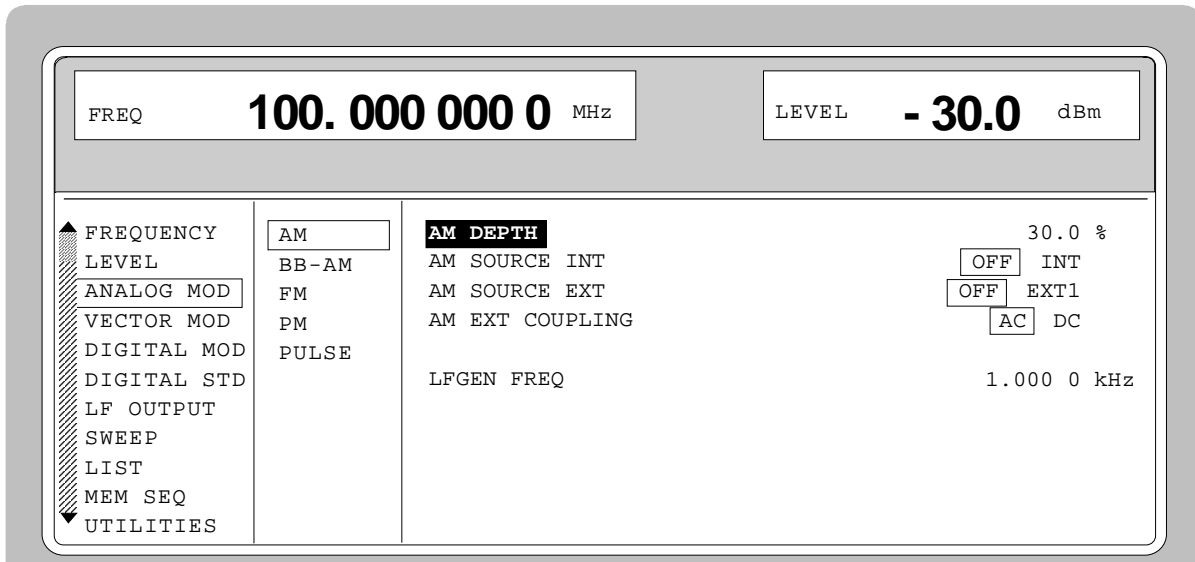

Fig. 2-26 Menu ANALOG MOD-AM (preset setting)

AM DEPTH	Input value of the modulation depth. IEC/IEEE-bus command SOUR:AM 30PCT
AM SOURCE INT	Selection of the internal source. IEC/IEEE-bus command SOUR:AM:SOUR INT1; STAT ON
AM SOURCE EXT	Selection of the external source. IEC/IEEE-bus command SOUR:AM:SOUR EXT; STAT ON
AM EXT COUPLING	Selection of the kind of coupling AC or DC with external supply (input EXT1). IEC/IEEE-bus command SOUR:AM:EXT:COUP AC
LFGEN FREQ	Input value of the frequency of the LF generator. IEC/IEEE-bus command SOUR:AM:INT:FREQ 1kHz

2.7.2 Broadband AM (BB-AM)

In the BB-AM mode the I/Q modulator is used for amplitude modulation. Level control should be set to AUTO or ON (see section, Switching On/Off Internal Level Control).

The modulation input (BB-AM) is identical with the I input of the I/Q modulator. The input impedance is 50 Ω. A signal of -0.25 V to +0.25 V corresponds to an amplitude modulation of -100% to +100%. Setting the modulation depth with BB-AM is not possible.

- Notes:**
- For Broadband AM the value for the upper level limit is the same as for vector modulation. Depending on the modulation depth, PEP can exceed the displayed value by up to 6 dB.
 - Broadband AM cannot be selected together with normal AM or vector modulation. These modulation deactivate one another

Menu selection: ANALOG MOD - BB-AM

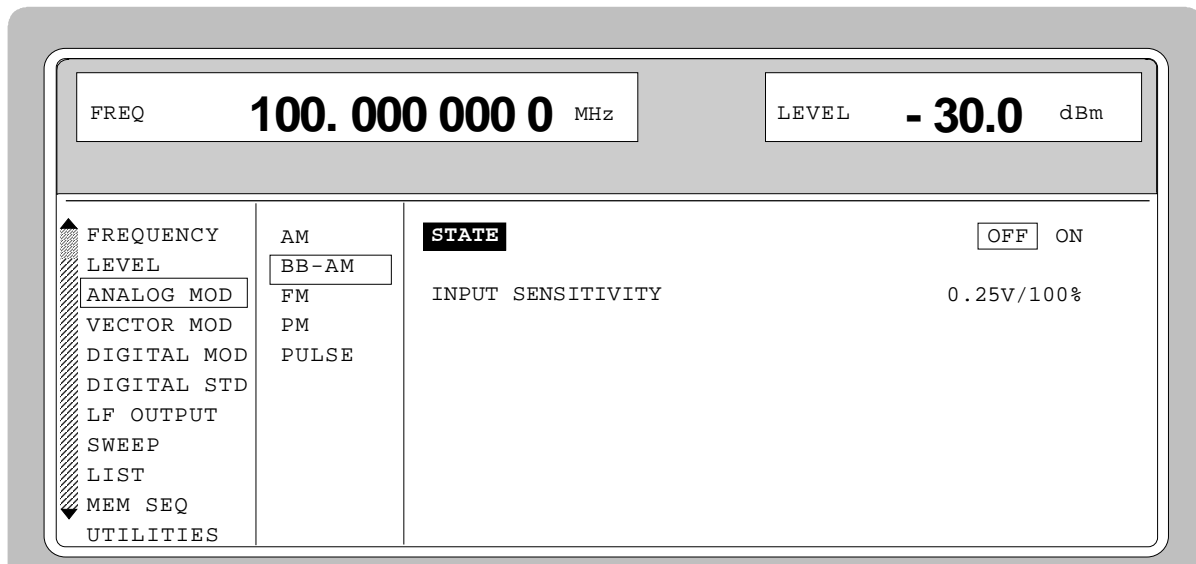

Fig. 2-27 Menu ANALOG MOD - BB-AM (preset setting)

STATE Switches BB-AM on and off.
IEC/IEEE-bus command SOUR:AM:BBAN ON

INPUT SENSITIVITY Display of the input sensitivity. The value cannot be changed.

2.7.3 Frequency Modulation

Menu ANALOG MOD-FM offers access to settings for frequency modulation.

Note: The FM and PM modulations cannot be set simultaneously and deactivate one another:

Menu selection: ANALOG MOD-FM

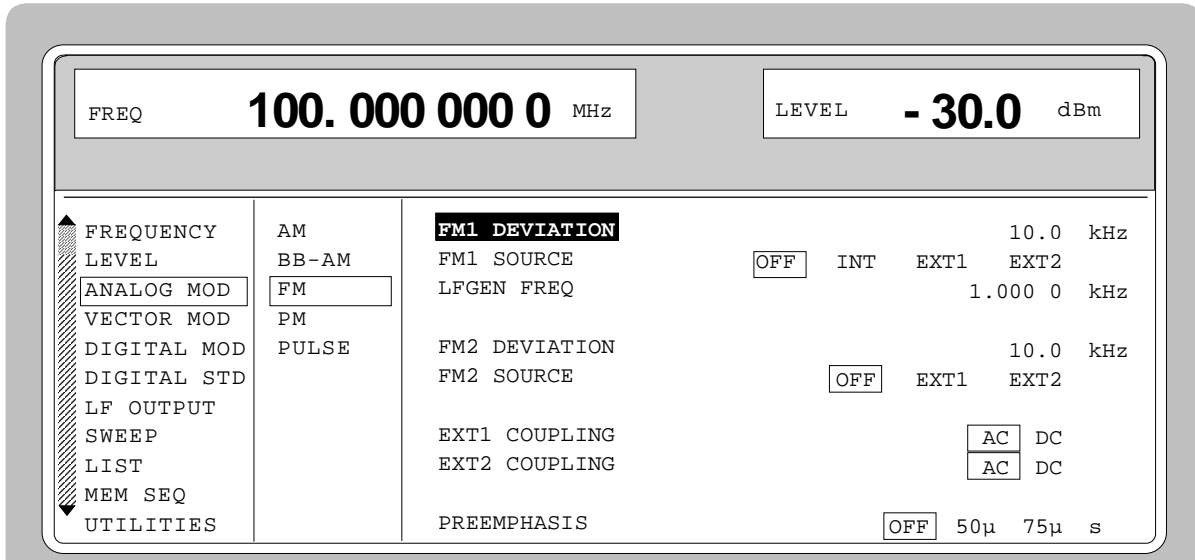

Fig. 2-28 Menu ANALOG MOD-FM (preset setting), fitted with option SM-B5, FM/PM-modulator

FM1 DEVIATION	Input value of the deviation for FM1. IEC/IEEE-bus command SOUR:FM1 10kHz
FM1 SOURCE	Switching on and off FM1 and selection of the modulation source. IEC/IEEE-bus command SOUR:FM1:SOUR INT; STAT ON
LFGEN FREQ	Input value of the frequency of the LF generator. EC-bus short command SOUR:FM1:INT:FREQ 1kHz
FM2 DEVIATION	Input value of the deviation for FM2. EC-bus short command SOUR:FM2 10kHz
FM2 SOURCE	Switching on and off FM2 and selection of the modulation source. EC-bus short command SOUR:FM2:STAT OFF
EXT1 COUPLING	Selection of the type of coupling AC or DC for the external input EXT1. IEC/IEEE-bus command SOUR:FM1:EXT1:COUP AC
EXT2 COUPLING	Selection of the type of coupling AC or DC for the external input EXT2. IEC/IEEE-bus command SOUR:FM1:EXT2:COUP AC
PREEMPHASIS	Selection of the preemphasis IEC-bus short command SOUR:FM1:PRE 50us

2.7.3.1 FM Deviation Limits

The maximal deviation depends on the RF frequency set (cf. Fig. 2-29). It is possible to enter a deviation that is too high for a certain RF frequency or to vary the RF frequency to a range in which the deviation can no longer be set. In this case the maximally possible deviation is set and an error message is displayed.

In the RF range 450 MHz to 750 MHz and 1200 MHz to 1500 MHz a different synthesis range is selected depending on the deviation set. If the deviation is smaller than 500 kHz or 1000 kHz, the synthesizer is in the normal mode with optimal spectral purity. If the deviation set is larger the I/Q mode is automatically selected.

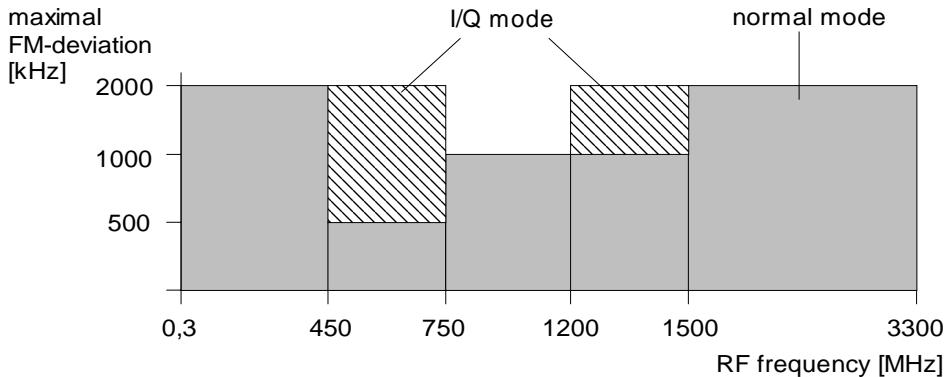

Fig. 2-29 Dependency of the FM maximal deviation on the RF frequency set

2.7.3.2 Preemphasis

Preemphasis results in a preemphasis of the modulation signal with time constants 50 μ s or 75 μ s. The higher frequencies of the modulation signal are preemphasized.

When preemphasis is switched on, only 1/4 of the maximal deviation is permissible. The highest permissible modulation frequency is 15 kHz. Exceeding the permissible modulation frequency can lead to overmodulation."

2.7.4 Phase Modulation

Menu ANALOG MOD-PM offers access to settings for phase modulation.

Note: The PM and FM modulations cannot be set simultaneously and deactivate one another.

Menu selection: ANALOG MOD - PM

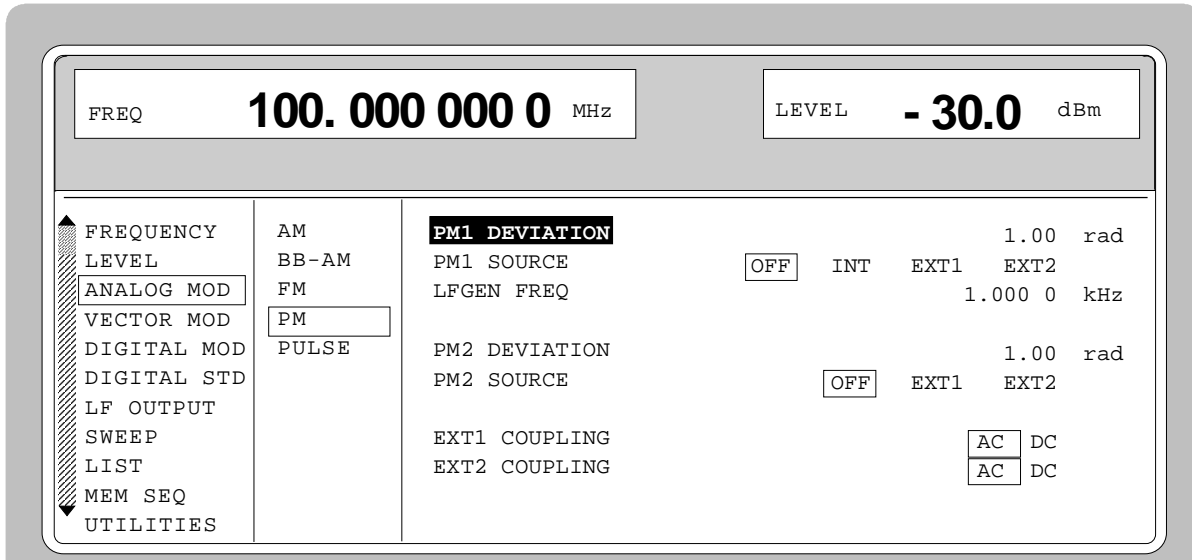

Fig. 2-30 Menu ANALOG MOD - PM (preset setting), fitted with option SM-B5, FM/PM-modulator

PM1 DEVIATION	Input value of the deviation for PM1. IEC/IEEE-bus command SOUR:PM1 1RAD
PM1 SOURCE	Switching on and off PM1 and selection of the modulation source. IEC/IEEE-bus command SOUR:PM1:SOUR:INT; STAT ON
LFGEN1 FREQ	Input value of the frequency of the LF generator. IEC/IEEE-bus command SOUR:PM1:INT:FREQ 1kHz
PM2 DEVIATION	Input value of the deviation for PM2. IEC/IEEE-bus command SOUR:PM2 1RAD
PM2 SOURCE	Switching on and off PM2 and selection of the modulation source. IEC/IEEE-bus command SOUR:PM2:SOUR INT; STAT ON
EXT1 COUPLING	Selection of the type of coupling AC or DC with external supply for PM1 (input EXT1). IEC/IEEE-bus command SOUR:PM:EXT1:COUP AC
EXT2 COUPLING	Selection of the type of coupling AC or DC with external supply for PM2 (input EXT2). IEC/IEEE-bus command SOUR:PM:EXT2:COUP AC

2.7.4.1 PM Deviation Limits

The maximal deviation depends on the RF frequency set (cf. Fig. 2-31). It is possible to enter a deviation that is too high for a certain RF frequency or to vary the RF frequency to a range in which the deviation can no longer be set. In this case the maximally possible deviation is set and an error message displayed.

In the RF range 450 to 750 MHz and 1200 MHz to 1500 MHz a different synthesis range is selected depending on the deviation set. If the deviation is smaller than 5 rad or 10 rad, the synthesizer is in the normal mode with optimal spectral purity. If the deviation set is larger, the I/Q mode is automatically selected.

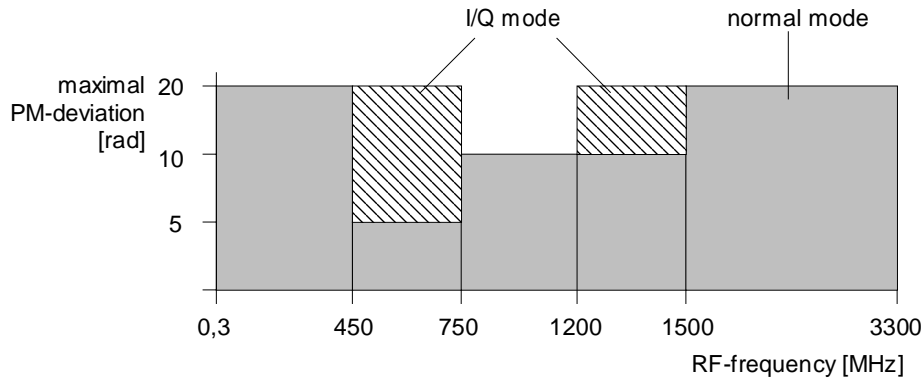

Fig. 2-31 Dependency of the PM maximal deviation on the RF frequency set

2.7.5 Pulse Modulation

The pulse modulator can be controlled by an external source at the PULSE input.

The polarity of the pulse modulation is selectable. With POLARITY = NORM, the RF level is on with HIGH level at modulation input PULSE.

Menu MODULATION-PULSE offers access to settings for pulse modulation

Menu selection: MODULATION - PULSE

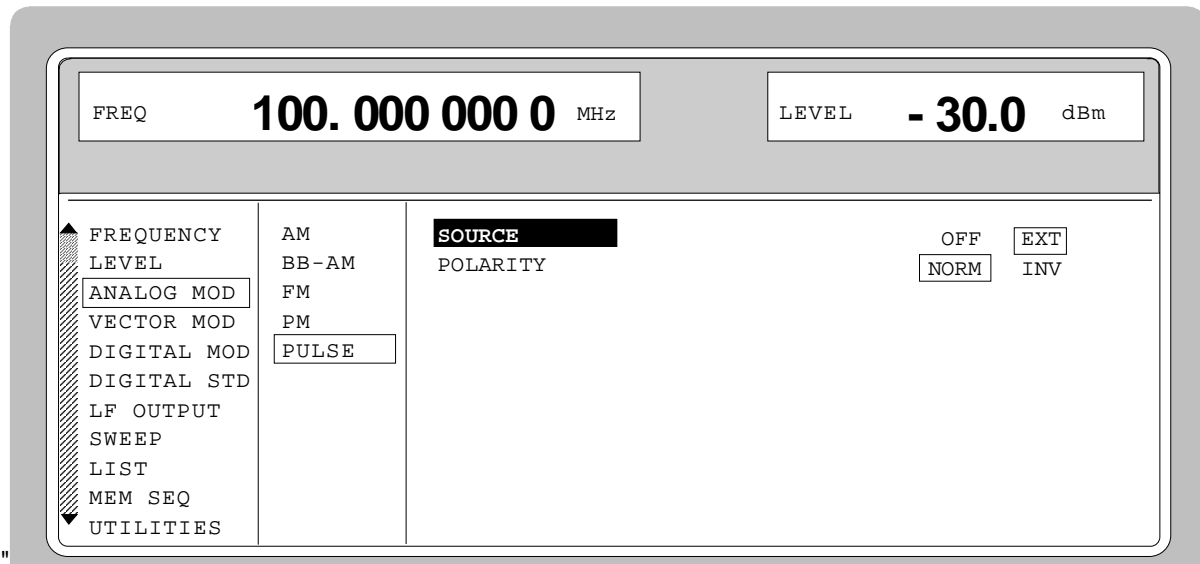

Fig. 2-32 Menu MODULATION-PULSE (preset setting), fitted with option SM-B3, pulse modulator, and option SM-B4, pulse generator

SOURCE Switching on or off the external pulse modulation.
IEC/IEEE-bus command : SOUR:PULM:SOUR EXT; STAT ON

POLARITY Selection of the polarity of the modulation
NORM The RF signal is on during high level.
INV The RF signal is suppressed during high level.
IEC/IEEE-bus command : SOUR:PULM:POL NORM

2.8 Vector Modulation

In the vector modulation mode (I/Q modulation) external modulation signals can be applied to modulation inputs I and Q for a complex modulation of the RF carrier.

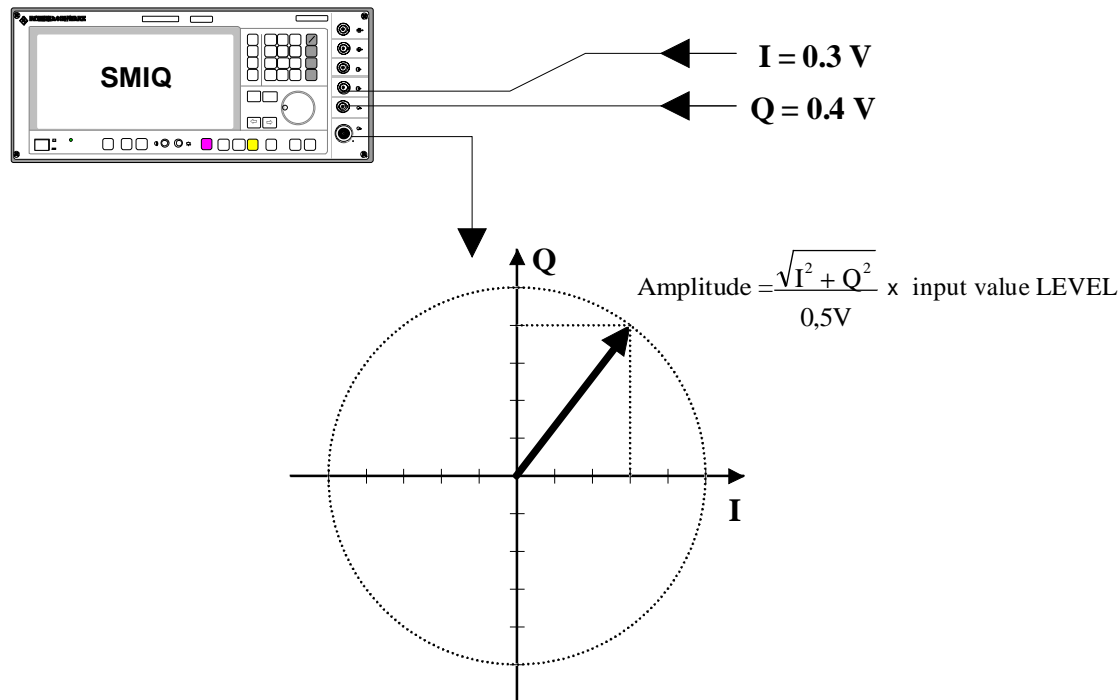

Fig. 2-33 Example: vector modulation

If the I/Q modulator is driven by a constant sum vector modulation of $\sqrt{I^2 + Q^2} = 0.5V$ the actual RF level corresponds to the displayed RF level. To avoid the I/Q modulator being overdriven, care should be taken that the sum vector never exceeds 0.5 V when digital modulation modes with amplitude modulation components such as QPSK are used. For full-scale input, the peak envelope power of the modulated RF signal is thus equal to the indicated LEVEL. The average power is smaller. The difference can be entered as an offset in the LEVEL menu.

Vector modulation settings are accessible in the VECTOR MOD menu, see following page.

- Note:**
- Types of modulation VECTOR MOD and BB-AM cannot be set at the same time; they switch each other off.
 - A selectable internal calibration of the I/Q modulator allows accurate and reproducible measurements to be made. The calibration routine should be called up with the CALIBRATE ► in the menu VECTOR MOD or UTILITIES-CALIB-VECTOR MOD after temperature changes of more than 5° C.

Menu selection: VECTOR MOD



Fig. 2-34 VECTOR MOD menu (preset settings), equipped with option SMIQB47 and IQMOD var. 8 or higher

STATE	Switches the vector modulation on and off. IEC/IEEE-bus command SOUR:DM:IQ:STAT ON
POWER RAMP CONTROL	Switches the POW RAMP input for analog level control on and off. Thus an external control signal can be used for carrier envelope modulation in parallel to vector modulation. IEC/IEEE-bus command SOUR:DM:IQ:PRAM AEXT
IMPAIRMENT STATE	Switches I/Q impairment on and off. IEC/IEEE-bus command SOUR:DM:IQ:IMP:STAT ON
LEAKAGE	Value entered for residual carrier . IEC/IEEE-bus command SOUR:DM:LEAK 10PCT
IMBALANCE	Value entered for imbalanced modulation of I and Q vectors. IEC/IEEE-bus command SOUR:DM:IQR -5PCT
QUADRATURE OFFSET	Value entered for quadrature offset . IEC/IEEE-bus command SOUR:DM:QUAD:ANGL 4DEG
IQ SWAP	Selection between normal and inverted I/Q modulation. Interchanging the I and Q signals inverts the modulation sidebands. OFF Normal I/Q modulation. ON I and Q signals interchanged. IEC/IEEE-bus command SOUR:DM:IQSW:STAT ON
CW > IQ TRANSITION	Selection between normal and fast setting time during the transition to CW after vector modulation (including DIGITAL MOD, DIGITAL STD and ARB MOD). In the FAST mode, the CW-IQ mode is activated for CW and the poorer spectral characteristics of vector modulation apply. For this reason, the FAST mode should be activated only if very fast switchover between CW and VECTOR MOD is required. IEC/IEEE-bus command : SOUR:DM:IQ:TRAN:NORM FAST

IQ FILTER

Only available with option SMIQB47.

Selection between no filter and a 850 kHz, a 2.5 MHz or a 5 MHz lowpass in the baseband. A filter of these types suppresses noise in the baseband above 900 kHz, 3 MHz or 6 MHz, which improves ACP (Adjacent Channel Power) for IS95 and W-CDMA. The frequency response of the filter is automatically compensated for DIGITAL MOD and DIGITAL STD in MCODE, which means that the EVM (Error Vector Magnitude) gets hardly worse. For VECTOR MOD and AMIQ with WinIQSIM as source, the frequency response is also compensated in WinIQSIM. For applications requiring a minimum EVM, the IQ filter should be set to OFF.

OFF	no filter
850 kHz	850 kHz lowpass
2.5 MHz	2.5 MHz lowpass
5 MHz	5 MHz lowpass

```
IEC/IEEE-bus commands      : SOUR:DM:IQ:FILT:STAT ON|OFF
                           : SOUR:DM:IQ:FILT:FREQ 2.5MHZ
```

2.8.1 I/Q Impairment

For simulating an impairment of the vector modulation, a residual carrier (LEAKAGE), imbalanced I and Q modulation (IMBALANCE) and a quadrature offset can be entered. The input values for LEAKAGE and IMBALANCE are with reference to the voltage.

Table 2-3 Parameter setting ranges

Parameter	Setting range	Resolution
LEAKAGE	0 ... 50 %	0.5 %
IMBALANCE	-12 ... +12 %	0.1 %
QUADRATURE OFFSET	-10 ... +10°	0.1°

The following figure shows the effect of I/Q impairment.

LEAKAGE:

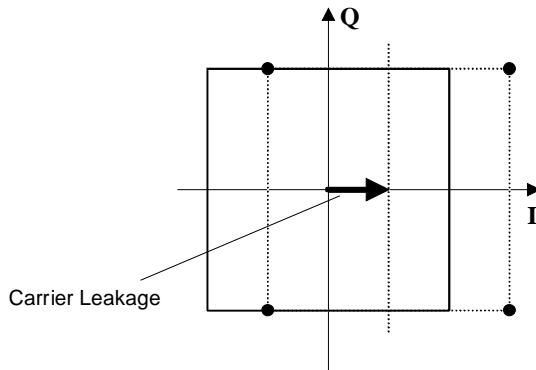

IMBALANCE:

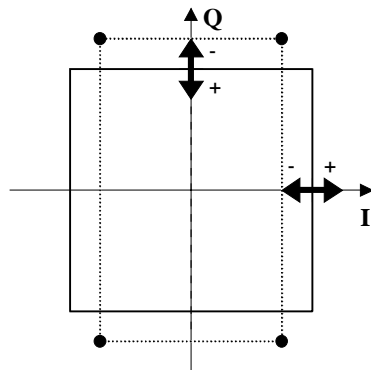

QUADRATURE OFFSET:

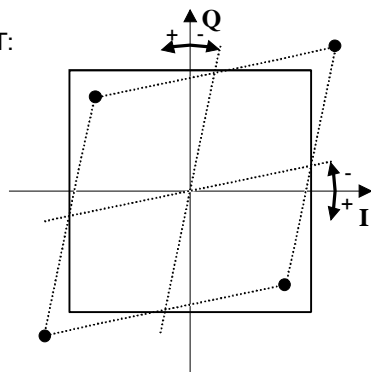

Fig. 2-35 Effect of I/Q impairment

2.9 Fading Simulation

By means of the option Fading Simulator SMIQB14, multipath fading signals with 6 independent transmission paths can be generated.

Important: The Fading Simulator can only be operated with the complex baseband signals I and Q. Therefore, it is necessary to switch on either Vector Modulation or Digital Modulation.

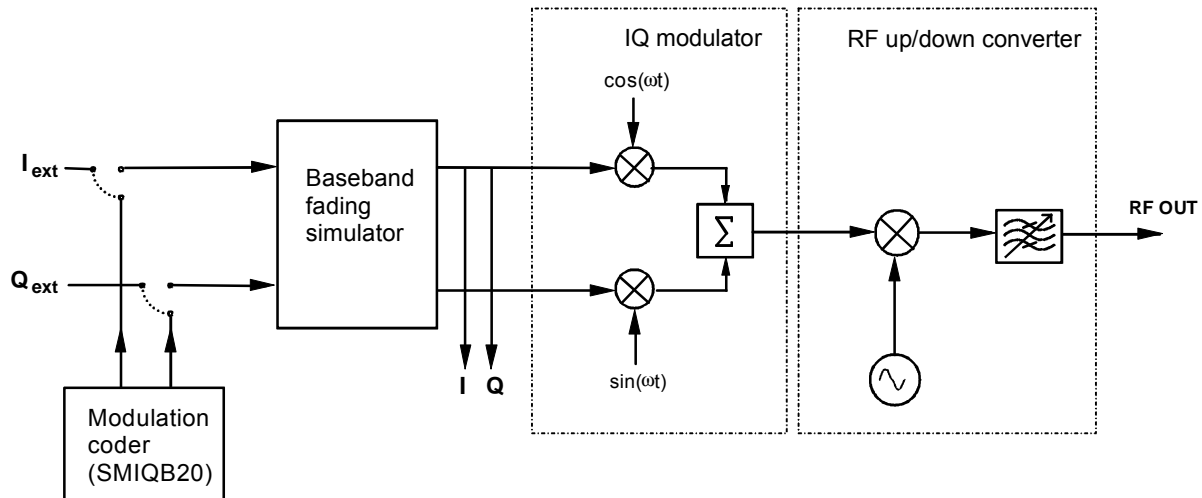

Fig. 2-36 Fading simulator in the SMIQ

The input signals for the fading simulator can either be applied to the modulation inputs I and Q or will be generated in the SMIQ by the optional Modulation Coder (SMIQB20). The output signals of the fading simulator will be passed to the IQ Modulator and then be mixed to the RF.

SMIQ can also be equipped with two Fading Simulators (SMIQB14 and SMIQB15). The second fading option provides another 6 transmission paths.

If only one fading simulator is built in, output signals I and Q are available at the I FADED and Q FADED connectors.

If two fading simulators are built in, the sum signal of the two fading options with 12 fading paths are available at the I FADED and Q FADED connectors.

Note: If option SMIQB17 (NDSIM) is fitted, the faded, noisy and distorted I/Q signals are present at the I FADED and Q FADED connectors. If neither noise nor distortion is desired, set *DISTORTION* in the *NOISE/DIST* menu to ON and select the predefined *TEST* list under *SELECT LIST* to make sure that an output signal is present at the I FADED and Q FADED connectors.

A selectable internal calibration of the fading simulator allows internal compensation of DC offset voltages. The calibration routine should be called up after temperature changes of more than 5 degree in menu *UTILITIES-CALIB-VECTOR MOD*.

2.9.1 Output Power with Fading

With a PATH LOSS setting of 0 dB, a single path of the fading simulator introduces an insertion loss between 12 dB and 18 dB for the IQ signals applied (with Insertion Loss Setting Mode = NORMAL). This insertion loss provides a headroom if several paths are superimposed on one another and also for the statistical influences to which a path is exposed. In the LOW ACP mode, the insertion loss is reduced to approx. 6 dB to 12 dB. This may lead to the rare case of clipping level being attained in the instrument. The IQ signals are in such case limited to the maximum level (clipping). The corresponding insertion loss is automatically corrected in the SMIQ. The output power is kept constant.

Displays:

LEVEL: The rms value of the output signal is displayed.
 PEP: The (theoretically possible) peak value is displayed. This value is attained if clipping level is reached both for the I and the Q path. For signals with a high crest factor it is not likely that the PEP value is attained.

Due to the insertion loss introduced by the fading simulator, the maximum output power of the SMIQ is reduced by max. 18 dB.

2.9.2 Two-Channel Fading

For two-channel fading, an SMIQ with two fading options (SMIQB14 and SMIQB15) and a second SMIQ without fading options is required. Moreover, the SMIQ has to be recabled internally, see description in Chapter 1, Section "Option SMIQB15 – Second Fading Simulator". After reconnecting the internal cables, the I/Q baseband signals of the second channel (SMIQB15) are available at connectors I FADED and Q FADED on the rear panel of the unit. On the second unit, vector modulation has to be switched on.

Notes: - Because of the insertion loss introduced by the fading simulator in the first SMIQ, the second SMIQ is not driven correctly. For the second SMIQ to be driven correctly, the current insertion loss of the first SMIQ must be determined and entered into the second SMIQ. This correction can be made by entering a CREST FACTOR in the vector modulation menu of the second SMIQ. The numerical value to be entered can be taken from the first SMIQ from the line SET SECOND SMIQ CREST FACTOR TO in the fading menu. After this value has been entered, the second SMIQ supplies the output level indicated in the menu.
 - For calibration of the two output levels (with Fading Simulator) it is necessary to leave the Fading Simulator in the signal path and to switch off fading. At this purpose, select setting "CALIBRATE" with Standard in the Fading Simulator menu.

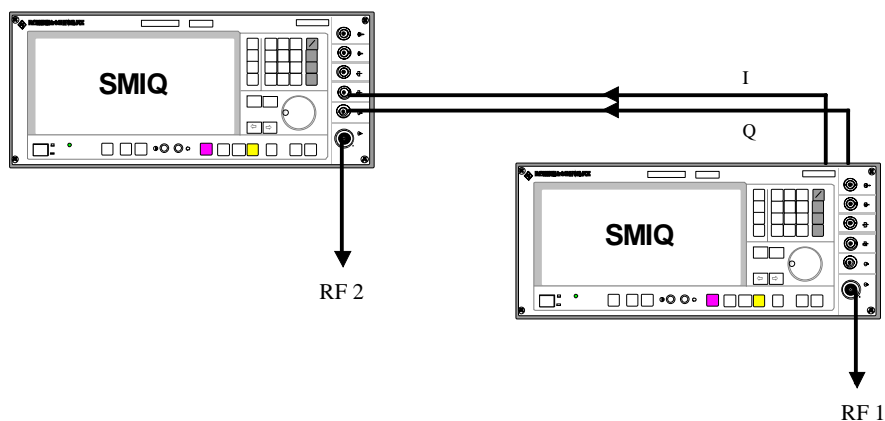

Fig. 2-37 Two-channel fading

2.9.3 Correlation between Paths

Fading processes of different paths normally do not depend on statistical processes. However, it is possible to set a correlation of paths 1 to 6 with paths 7 to 12 in pairs. To set the correlation, a synchronous signal processing is required for the two fading options which involves the following restrictions:

- The correlation is always reciprocal, ie if path 1 is correlated with path 7, path 7 is also correlated with path 1 (CORR PATH).
- The following parameters of the two paths have to correspond:
 - Fading profile PROFILE
 - Doppler parameter SPEED or DOPPLER FREQ
 - Magnitude of correlation coefficient COEFF
- The following equation applies to the phase of the correlation coefficient and thus to the phase shift between the correlated paths:

$$\varphi_{12} = 360^\circ - \varphi_{21}$$

- The parameters for Log Normal fading have to correspond for correlated paths.

All parameter adaptations due to the limitations mentioned before are automatically performed by SMIQ.

Note: After setting all parameters, the two fading options have to be synchronized by RESET and then by RUN.

2.9.4 Menu FADING SIM

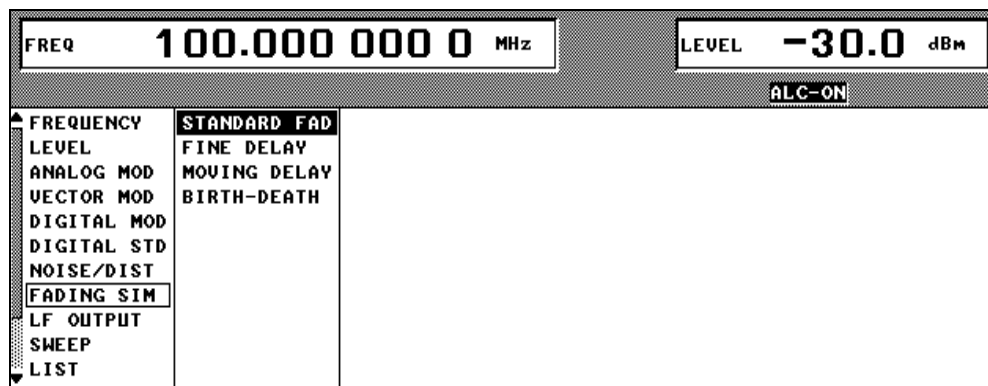

Fig. 2-38 Menu FADING SIM with submenus

FADING SIM	Selection of fading simulator mode.
STANDARD FAD	"Normal" mode with 6 paths (with option SMIQB14) or 12 paths (with SMIQB14 and SMIQB15), time resolution 50 ns.
FINE DELAY	Mode with fine time resolution. Two paths are possible for each option (SMIQB14 / SMIQB15). The system bandwidth of the paths is limited to 4.6 MHz; this is sufficient for 3GPP with 3.84 Msymb/s. Time resolution is 1 ns.
MOVING DELAY	Mode with 2 paths, one with a fixed delay, the other with a delay varying sinusoidally. This corresponds to test case 3GPP, 25.104-320, Annex B3.
BIRTH-DEATH	Mode with 2 paths with a delay randomly varying within a time range.

Note: The modes FINE DELAY, MOVING DELAY, BIRTH-DEATH are possible only if software option SMIQB49 is built in.

2.9.4.1 Menu STANDARD FADING

The settings for fading simulation can be accessed via the FADING SIM menu.

Menu selection: FADING SIM

FREQ 100.000 000 0 MHz		LEVEL -30.0 dBm																																																																																					
		PEP -13.1 dBm																																																																																					
QPSK FSIM		ALC-S&H																																																																																					
FREQUENCY LEVEL ANALOG MOD VECTOR MOD DIGITAL MOD DIGITAL STD NOISE/DIST FADING SIM LF OUTPUT SWEEP LIST		CONFIGURATION MODE RESET ► IGNORE RF CHANGES < 5% STANDARD... SPEED UNIT INSERTION LOSS SETTING MODE COUPLED PARAMETERS... SET DEFAULT ► PATH STATE PROFILE DISCRETE COMP FREQ RATIO SPEED DOPPLER FREQ PATH LOSS DELAY LOGNORM STATE LOCAL CONST STD DEV																																																																																					
		OFF 1CH_6P RUN STOP OFF ON M/S km/h mph NORMAL LOW_ACP																																																																																					
		<table border="1"> <thead> <tr> <th></th> <th>1</th> <th>2</th> <th>3</th> <th>4</th> <th>5</th> <th>6</th> </tr> </thead> <tbody> <tr> <td>STATE</td> <td>ON</td> <td>ON</td> <td>OFF</td> <td>OFF</td> <td>OFF</td> <td>OFF</td> </tr> <tr> <td>PROFILE</td> <td>PDOPP</td> <td>PDOPP</td> <td>RAYL</td> <td>RAYL</td> <td>RAYL</td> <td>RAYL</td> </tr> <tr> <td>DISCRETE COMP</td> <td>ON</td> <td>ON</td> <td>OFF</td> <td>OFF</td> <td>OFF</td> <td>OFF</td> </tr> <tr> <td>FREQ RATIO</td> <td>+1.00</td> <td>+1.00</td> <td></td> <td></td> <td></td> <td></td> </tr> <tr> <td>SPEED</td> <td>20.000</td> <td>20.000</td> <td>20.000</td> <td>20.000</td> <td>20.000</td> <td>20.000 m/s</td> </tr> <tr> <td>DOPPLER FREQ</td> <td>6.7</td> <td>6.7</td> <td>6.7</td> <td>6.7</td> <td>6.7</td> <td>6.7 Hz</td> </tr> <tr> <td>PATH LOSS</td> <td>0.0</td> <td>0.0</td> <td>0.0</td> <td>0.0</td> <td>0.0</td> <td>0.0 dB</td> </tr> <tr> <td>DELAY</td> <td>0.00</td> <td>0.00</td> <td>0.00</td> <td>0.00</td> <td>0.00</td> <td>0.00 μs</td> </tr> <tr> <td>LOGNORM STATE</td> <td>OFF</td> <td>OFF</td> <td>OFF</td> <td>OFF</td> <td>OFF</td> <td>OFF</td> </tr> <tr> <td>LOCAL CONST</td> <td>200.0</td> <td>200.0</td> <td>200.0</td> <td>200.0</td> <td>200.0</td> <td>200.0 m</td> </tr> <tr> <td>STD DEV</td> <td>0</td> <td>0</td> <td>0</td> <td>0</td> <td>0</td> <td>0 dB</td> </tr> </tbody> </table>			1	2	3	4	5	6	STATE	ON	ON	OFF	OFF	OFF	OFF	PROFILE	PDOPP	PDOPP	RAYL	RAYL	RAYL	RAYL	DISCRETE COMP	ON	ON	OFF	OFF	OFF	OFF	FREQ RATIO	+1.00	+1.00					SPEED	20.000	20.000	20.000	20.000	20.000	20.000 m/s	DOPPLER FREQ	6.7	6.7	6.7	6.7	6.7	6.7 Hz	PATH LOSS	0.0	0.0	0.0	0.0	0.0	0.0 dB	DELAY	0.00	0.00	0.00	0.00	0.00	0.00 μs	LOGNORM STATE	OFF	OFF	OFF	OFF	OFF	OFF	LOCAL CONST	200.0	200.0	200.0	200.0	200.0	200.0 m	STD DEV	0	0	0	0	0	0 dB
	1	2	3	4	5	6																																																																																	
STATE	ON	ON	OFF	OFF	OFF	OFF																																																																																	
PROFILE	PDOPP	PDOPP	RAYL	RAYL	RAYL	RAYL																																																																																	
DISCRETE COMP	ON	ON	OFF	OFF	OFF	OFF																																																																																	
FREQ RATIO	+1.00	+1.00																																																																																					
SPEED	20.000	20.000	20.000	20.000	20.000	20.000 m/s																																																																																	
DOPPLER FREQ	6.7	6.7	6.7	6.7	6.7	6.7 Hz																																																																																	
PATH LOSS	0.0	0.0	0.0	0.0	0.0	0.0 dB																																																																																	
DELAY	0.00	0.00	0.00	0.00	0.00	0.00 μs																																																																																	
LOGNORM STATE	OFF	OFF	OFF	OFF	OFF	OFF																																																																																	
LOCAL CONST	200.0	200.0	200.0	200.0	200.0	200.0 m																																																																																	
STD DEV	0	0	0	0	0	0 dB																																																																																	

Fig. 2-39 Menu STANDARD FADING (two Fading Simulators installed)

- CONFIGURATION** Switching on fading simulation by selection of the number of active paths and channels.
- 1CH_6P One channel with 6 paths (with option SMIQB14)
 - 1CH_12P One channel with 12 paths (with SMIQB14 and SMIQB15)
 - 2CH_6+6 Two channels with 6 paths each (with SMIQB14 and SMIQB15)
- IEC/IEEE-bus command SOUR:FSIM:CONF S12P
SOUR:FSIM ON
- MODE** Stopping (STOP) and starting (RUN) the fading process.
Following RESET the mode RUN starts the Pseudo Noise Generator at a defined starting point for generating the fading process.
IEC/IEEE-bus command SOUR:FSIM:SEQ RUN
- RESET ►** Resetting the Pseudo Noise Generator.
If RESET is set, the parameter MODE is automatically set to STOP. RESET also ensures a synchronization of the two fading options during 2-channel mode with the correlation switched on.
IEC/IEEE-bus command :SOUR:FSIM:SEQ:RES
- IGNORE RF CHANGES < 5% ►** In the ON state, frequency variations below 5% are ignored. This enables RF hopping faster than 3 ms. IEC/IEEE-bus command
:SOUR:FSIM:IGN:RFCH ON

STANDARD	<p>Opens a window for selecting a standard setting of the fading paths. The parameter settings comply with the measurement specifications of mobile communication standards (e.g. GSM, CDMA, NADC).</p> <p>With standards TETRA TYPICAL URBAN and TETRA HILLY TERRAIN, all 6 paths are used with these parameters instead of the stipulated 2 paths. This yields an improved residual carrier with the same output signal.</p> <p>IEC/IEEE-bus command <code>SOUR:FSIM:STAN CDMA100</code></p>
SPEED UNIT	<p>Selection of the speed unit.</p> <p>IEC/IEEE-bus command <code>:SOUR:FSIM:SPE:UNIT KMPH</code></p>
INSERTION LOSS SETTING MODE	<p>Selection of setting mode for the insertion loss of the fading simulator.</p> <p>NORMAL The minimum insertion loss for a path of the fading simulator is fixed to 18 dB. The value has been chosen so that even with Log Normal-Fading switched on, the fading simulator will seldom be overdriven. This setting should be chosen for BER measurements.</p> <p>IEC/IEEE-bus command <code>:SOUR:FSIM:ILOS:MODE NORM</code></p> <p>LOW_ACP The minimum insertion loss is between 6 and 12 dB. The value depends on the PATH LOSS setting of the selected paths. This mode is ideal for all STANDARD menu settings regarding signal/noise ratio and residual carrier suppression. This setting should be chosen for measurements which involve an adjacent-channel interfering signal generated by the SMIQ.</p> <p>IEC/IEEE-bus command <code>:SOUR:FSIM:ILOS:MODE LACP</code></p>
SHOW PATHS	<p>Switching from the display of paths 1 to 6 to the display of paths 7 to 12.</p>
COUPLED PARAMETERS...	<p>In this submenu, parameters SPEED, COEFF, LOCAL CONST and STD DEV can be coupled via the ON setting. If one of these parameters is modified afterwards in a particular path, the parameters of all other paths will be modified.</p> <p>SPEED SETTING COUPLED ON Parameters coupled for all paths. OFF Parameter can be set individually. IEC/IEEE : <code>SOUR:FSIM:COUP:SPE ON</code></p> <p>CORR COEFF SETTING COUPLED ON Parameters coupled for all paths. OFF Parameter can be set individually. IEC/IEEE : <code>SOUR:FSIM:COUP:CORR:COEF ON</code></p> <p>LOCAL CONST SETTING COUPLED ON Parameters coupled for all paths. OFF Parameter can be set individually. IEC/IEEE : <code>SOUR:FSIM:COUP:LOGN:LCON ON</code></p> <p>STD DEV SETTING COUPLED ON Parameters coupled for all paths. OFF Parameter can be set individually. IEC/IEEE : <code>SOUR:FSIM:COUP:LOGN:CSTD ON</code></p>
SET SECOND SMIQ CREST FACTOR TO	<p>Indication of crest factor which has to be set on the second SMIQ in the vector modulation menu so that the insertion loss caused by the fading simulator (in the first SMIQ) is compensated correctly on the second SMIQ.</p> <p>IEC/IEEE-bus command <code>:SOUR:FSIM:CFAC:EXT?</code></p>
SET DEFAULT ►	<p>Default setting of path parameter with path 1 switched on and all other paths switched off.</p> <p>IEC/IEEE-bus command <code>:SOUR:FSIM:DEF</code></p>

PATH	The following parameter have to be set separately for each path.
STATE	Switching on and off a path. If the cursor is placed onto a path in the diagram, it may be switched on and off by pressing one of the unit keys (toggle function). IEC/IEEE-bus command : SOUR:FSIM:PATH3:STAT ON
PROFILE	Selection of the fading profile. <p>pDOPP (Pure DOPpler) Simulation of a transmission path having a single direct connection from the transmitter to the moving receiver (discrete component). The Doppler Frequency shift is determined by the parameters DOPPLER FREQ and FREQ RATIO. IEC/IEEE-bus command : SOUR:FSIM:PATH4:PROF PDOP</p> <p>RAYL (RAYLeigh) Simulation of a radio field, where a multitude of broadly scattered partial waves hit upon a moving receiver. The receiving amplitude resulting therefrom is time-varying. The probability density function of the receiving amplitude is described by a Rayleigh distribution. The fading spectrum is a classical Doppler spectrum. IEC/IEEE-bus command : SOUR:FSIM:PATH1:PROF RAYL</p> <p>RICE Simulation of a radio field, where apart from a multitude of scattered partial waves, one strong direct wave (discrete component) hits upon a moving receiver. The probability density function of the receiving amplitude is described by a Rice distribution. The fading spectrum of an unmodulated signal is an overlapping of a classical Doppler spectrum with a discrete spectrum line. IEC/IEEE-bus command : SOUR:FSIM:PATH7:PROF RICE</p> <p>CPHAS A radio traffic area without direct and random waves is generated for this fading type (no discrete and no static component). The path is multiplied by a constant "pointer" according to the path-specific parameter. IEC/IEEE-bus command : SOUR:FSIM:PATH3:PROF CPH</p>
DISCRETE COMP	Shows the status of the discrete component (ON or OFF). IEC/IEEE-bus command : SOUR:FSIM:PATH4:DCOM:STAT ON
POWER RATIO	Input value of the power ratio of the discrete component and distributed component with Ricean fading switched on. If POWER RATIO is changed the sum of both components remains constant. IEC/IEEE-bus command : SOUR:FSIM:PATH6:PRAT 3

FREQ RATIO Input value of the ratio of the actual Doppler Frequency shift to the Doppler Frequency setting with Ricean fading or Pure Doppler switched on. The actual Doppler Frequency shift depends on the simulated angle of incidence of the discrete component.

IEC/IEEE-bus command : SOUR:FSIM:PATH6:FRAT 1

ϕ / deg	0	90	180
FREQ RATIO	-1	0	+1

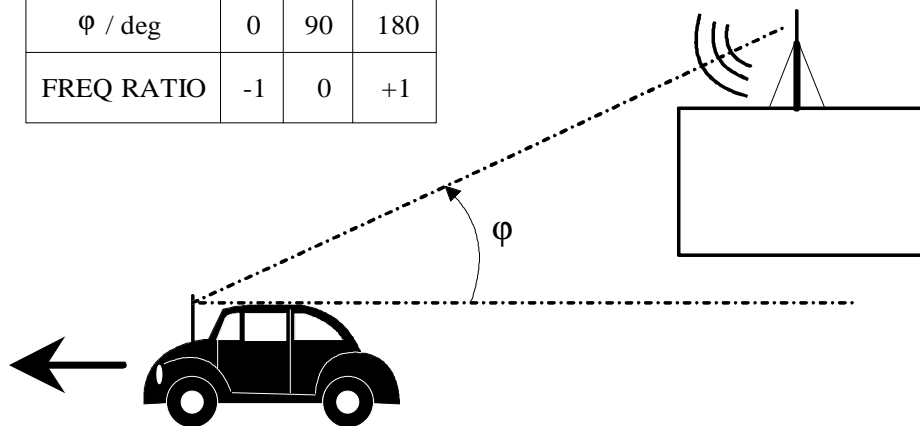

Fig. 2-40 Doppler Frequency shift with moving receiver

CONST PHASE Entry value of CONST PHASE with CPHAS fading switched on. The corresponding path is multiplied by this phase.

IEC/IEEE-bus command : SOUR:FSIM:PATH6:CPH 20.0

SPEED Input value of the speed v of the moving receiver. The Doppler frequency f_D (DOPPLER FREQ) is calculated from the speed and the RF frequency f_{RF} . When changing SPEED the parameter DOPPLER FREQ will be automatically adjusted. This parameter can be coupled, see parameter COUPLED PARAMETERS...

Range:
$$v_{\min} = \frac{0.03 \cdot 10^9 \text{ m/s}^2}{f_{RF}} \quad v_{\max} = \frac{479 \cdot 10^9 \text{ m/s}^2}{f_{RF}}$$

$$v_{\max} \leq 99999 \text{ km/h}$$

IEC/IEEE-bus command : SOUR:FSIM:PATH1:SPE 100

DOPPLER FREQ Input value of the amount of the maximum Doppler Frequency shift (cf. FREQ RATIO).

When changing the Doppler Frequency f_D the parameter SPEED will be automatically adjusted.

With $c = 2.998 \cdot 10^8 \text{ m/s}$ it is
$$\frac{v}{c} = \frac{f_D}{f_{RF}}$$

IEC/IEEE-bus command : SOUR:FSIM:PATH2:FDOP 92.3

PATH LOSS Input value of the attenuation of the path.

IEC/IEEE-bus command : SOUR:FSIM:PATH3:LOSS 3

DELAY Input value of the signal delay in the path.

IEC/IEEE-bus command : SOUR:FSIM:PATH3:DEL 14.5

CORR PATH	<p>Switching on or off (NONE) a correlation with the selected path. This setting is accessible if both fading options SMIQB14 and SMIQB15 have been installed. Only a two by two correlation of paths 1 to 6 with paths 7 to 12 can be set.</p> <p>IEC/IEEE-bus command : SOUR:FSIM:PATH6:CORR:PATH 12</p>
COEFF	<p>Input value of the amplitude of the complex correlation coefficient. This parameter can be coupled, see parameter COUPLED PARAMETERS...</p> <p>IEC/IEEE-bus command : SOUR:FSIM:PATH6:CORR:COEF 0.5</p>
PHASE	<p>Input value of the phase of the complex correlation coefficient.</p> <p>IEC/IEEE-bus command : SOUR:FSIM:PATH6:CORR:PHAS 180</p>
LOGNORM STATE	<p>Switching on or off the Log Normal-Fading.</p> <p>With Log Normal-Fading set, an additional rather slow continuous changing of the receiving amplitude of a moving receiver is simulated. Log Normal-Fading has a multiplying effect on the path loss. The multiplication factor is time-varying and logarithmically normally distributed. If a Rayleigh profile is set simultaneously, this results in Suzuki-Fading.</p> <p>IEC/IEEE-bus command : SOUR:FSIM:PATH6:LOGN:STAT ON</p>
LOCAL CONST	<p>Input value of the area constant L. This parameter can be coupled, see parameter COUPLED PARAMETERS...</p> <p>The area constant L and the speed v of the moving receiver determine the corner frequency f_L of Log Normal-Fading:</p> $f_L = v / L$ <p>The power density spectrum of an unmodulated carrier (CW) is an overlapping of a discrete spectrum line at f_{RF} with a frequency dependent continuous spectrum described by</p> $S(f) = \text{const} \cdot e^{-0.5 \cdot \left(\frac{f - f_{RF}}{f_L} \right)^2}$ <p>The lower limit of the range is dependent on the RF frequency f_{RF} :</p> $L_{\min} = \frac{12 \cdot 10^9 \text{ m/s}}{f_{RF}}$ <p>IEC/IEEE-bus command : SOUR:FSIM:PATH6:LOGN:LCON 150</p>
STD DEV	<p>Input value of the standard deviation of the Log Normal-Fading. This parameter can be coupled, see parameter COUPLED PARAMETERS...</p> <p>IEC/IEEE-bus command : SOUR:FSIM:PATH6:LOGN:CSTD 6</p>

2.9.4.2 Menu FINE DELAY

With the FINE DELAY mode a better time delay resolution of the paths is obtained. Two paths are possible for each option (SMIQB14 / SMIQB15). The system bandwidth of these paths is limited to 4.6 MHz, which is sufficient for 3GPP with 3.84 Msymb/s. Time resolution is 1 ns.

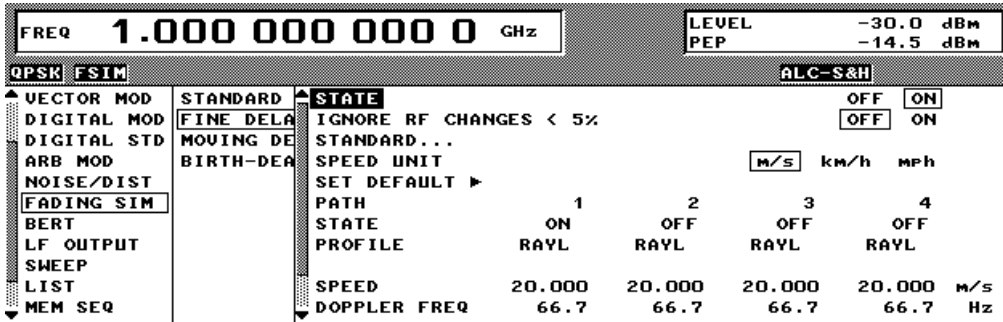

Fig. 2-41 Menu FINE DELAY

STATE

Activating/deactivating fine delay simulation.

IEC/IEEE-bus command : SOUR:FSIM:FDEL:STAT ON | OFF

IGNORE RF CHANGES < 5%

When switched on, frequency variations below 5% are ignored. Frequency hopping is thus faster than 3 ms. IEC/IEEE-bus command

: SOUR:FSIM:IGN:RFCH ON

STANDARD

Opens a window for selecting a defined setting of fading paths.

Selection:

```

3GPP_BS_4.1.0_CASE1:      SPEED:   3 km/h
                           Pfad 1:   DELAY    25 ns
                           PATH LOSS  0 dB
                           Pfad 2:   DELAY   1001 ns
                           PATH LOSS  10 dB
3GPP_BS_4.1.0_CASE2:      SPEED:   3km/h
                           Pfad 1:   DELAY    25 ns
                           PATH LOSS  0 dB
                           Pfad 2:   DELAY   1001 ns
                           PATH LOSS  0 dB
                           Pfad 3:   DELAY  20025 ns
                           PATH LOSS  0 dB
3GPP_BS_4.1.0_CASE3:      SPEED:  120km/h
                           Pfad 1:   DELAY    25 ns
                           PATH LOSS  0 dB
                           Pfad 2:   DELAY   285 ns
                           PATH LOSS  3 dB
                           Pfad 3:   DELAY   546 ns
                           PATH LOSS  6 dB
                           Pfad 4:   DELAY   806 ns
                           PATH LOSS  9 dB
3GPP_3.3.1_CASE5:        SPEED:   50 km/h
                           Path 1:   DELAY    25 ns
                           PATH LOSS  0 dB
                           Path 2:   DELAY   1001 ns
                           PATH LOSS 10 dB
  
```

3GPP_BS_4.1.0_CASE4:	SPEED:	250 km/h
Pfad 1:	DELAY	25 ns
	PATH LOSS	0 dB
Pfad 2:	DELAY	285ns
	PATH LOSS	3 dB
Pfad 3:	DELAY	546 ns
	PATH LOSS	6 dB
Pfad 4:	DELAY	806 ns
	PATH LOSS	9 dB
3GPP_UE_4.1.0_CASE1:	SPEED:	3 km/h
Pfad 1:	DELAY	25 ns
	PATH LOSS	0 dB
Pfad 2:	DELAY	1001 ns
	PATH LOSS	10 dB
3GPP_UE_4.1.0_CASE2:	SPEED:	3km/h
Pfad 1:	DELAY	25 ns
	PATH LOSS	0 dB
Pfad 2:	DELAY	1001 ns
	PATH LOSS	0 dB
Pfad 3:	DELAY	20025 ns
	PATH LOSS	0 dB
3GPP_UE_4.1.0_CASE3:	SPEED:	120km/h
Pfad 1:	DELAY	25 ns
	PATH LOSS	0 dB
Pfad 2:	DELAY	285 ns
	PATH LOSS	3 dB
Pfad 3:	DELAY	546 ns
	PATH LOSS	6 dB
Pfad 4:	DELAY	806 ns
	PATH LOSS	9 dB
3GPP_UE_4.1.0_CASE4:	SPEED:	3km/h
Pfad 1:	DELAY	25 ns
	PATH LOSS	0 dB
Pfad 2:	DELAY	1001 ns
	PATH LOSS	0 dB
3GPP_UE_4.1.0_CASE5:	SPEED:	50km/h
Pfad 1:	DELAY	25 ns
	PATH LOSS	0 dB
Pfad 2:	DELAY	1001 ns
	PATH LOSS	10 dB
3GPP_UE_4.1.0_CASE6:	SPEED:	250km/h
Pfad 1:	DELAY	25 ns
	PATH LOSS	0 dB
Pfad 2:	DELAY	285 ns
	PATH LOSS	3 dB
Pfad 3:	DELAY	546 ns
	PATH LOSS	6 dB
Pfad 4:	DELAY	806 ns
	PATH LOSS	9 dB

	IEC/IEEE-bus command : SOUR:FSIM:FDEL:STAN G3C1
	IEC/IEEE-bus command : SOUR:FSIM:FDEL:STAN G3UECn (n=1...6)
	Notes:
	- The path delays correspond to those in 3GPP, TS 25.101 V4.1.0 (2001-06) und TS 25.141 V4.1.0 (2001-06). However, they include a basic delay of 25 ns of the Fading Simulator.
	- All test cases requiring more than 2 paths are only possible with option SMIQB15.
SPEED UNIT	Selection of the unit required for the speed of parameter SPEED.
	IEC/IEEE-bus command : SOUR:FSIM:FDEL:SPE:UNIT KMPH
SET DEFAULT ►	Sets the default setting of the path parameters with path 1 switched on and all other paths switched off.
	IEC/IEEE-bus command : SOUR:FSIM:FDEL:DEF
PATH	Indicates the paths for subsequent parameters. These parameters can be set individually for each path.
STATE	Switch-on/off of a path. If the cursor is placed onto a path, this path may be switched on or off by pressing one of the unit keys (toggle function).
	IEC/IEEE-bus command : SOUR:FSIM:FDEL:PATH2:STAT ON OFF
PROFILE	Selection of a fading profile. See explanations under Standard Fading. Only the following setting is possible:
	pDOPP
	IEC/IEEE-bus command : SOUR:FSIM:FDEL:PATH2:PROF PDOP
	RAYL (This setting is provided in the 3GPP test cases)
	IEC/IEEE-bus command : SOUR:FSIM:FDEL:PATH2:PROF RAYL
FREQ RATIO	Entry value of the ratio of the actual Doppler frequency shift to the set Doppler frequency with FDOP fading switched on. (See explanation under Standard Fading).
	IEC/IEEE-bus command : SOUR:FSIM:FDEL:PATH2:FRAT 1
SPEED	Entry value of the speed v of the moving receiver (see explanation under Standard Fading).
	IEC/IEEE-bus command : SOUR:FSIM:FDEL:PATH2:SPE 100
DOPPLER FREQ	Entry value of the magnitude of the maximum Doppler frequency shift (see explanation under Standard Fading).
	IEC/IEEE-bus command : SOUR:FSIM:FDEL:PATH2:FDOP 92.3
PATH LOSS	Entry value of attenuation in path. Value range: 0.0 to 50.0 dB.
	IEC/IEEE-bus command : SOUR:FSIM:FDEL:PATH2:LOSS 3
DELAY	Entry value of signal delay in path. Value range: 25 ns to 1637 μ s.
	IEC/IEEE-bus command : SOUR:FSIM:FDEL:PATH2:DEL 14.5E-6

2.9.4.3 Menu MOVING DELAY

In the MOVING DELAY mode, the Fading Simulator simulates the dynamic propagation conditions according to test case 3GPP, 25.104-320, Annex B3.

2 paths are simulated; the delay of path 1 remains unchanged, the delay of path 2 slowly moves to and fro sinusoidally. The two paths have no fading profile (non-fading), have the same level, the same phase and have no Doppler shift.

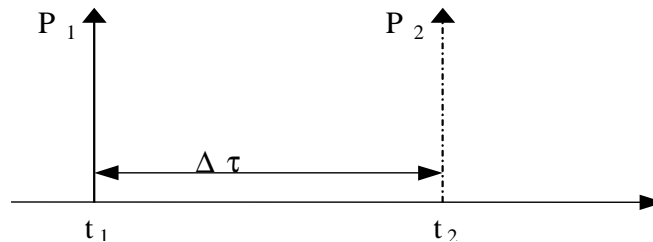

Fig. 2-42 Two paths with menu MOVING DELAY

The delay of the moving path is obtained with the following equation:

$$\Delta\tau = \left(DELAY_MEAN + \frac{DELAY_VARIATION}{2} \left(1 + \sin\left(\frac{2\pi \cdot t}{VARIATION_PERIOD}\right) \right) \right)$$

The following settings are required to obtain the values suggested in Annex B3:

DELAY (path 1)	1 μs
DELAY MEAN	= DELAY(path 1) + DELAY VARIATION / 2 = 3.5 μs
DELAY VARIATION	5 μs
VARIATION PERIOD	157 s

For further tests, DELAY MEAN and the variation parameters can be modified. The two paths can be levelled differently.

The screenshot shows the 'MOVING DELAY' menu. At the top, it displays 'FREQ 100.000 000 0 MHz', 'LEVEL -30.0 dBm', and 'PEP -13.1 dBm'. The menu is divided into sections: 'STATE' (OFF/ON), 'IGNORE RF CHANGES < 5%' (OFF/ON), and 'STANDARD...' (3GPP_3.0_MOVING). Below these are two path configurations: 'Reference Path' and 'Moving Path'. The 'Moving Path' section shows: PATH LOSS 0.0 dB, DELAY 0.00 μs, PATH LOSS 0.0 dB, DELAY MEAN 5.00 μs, DELAY VARIATION (PK-PK) 5.000 μs, and VARIATION PERIOD 157.0000 s.

Fig. 2-43 Menu MOVING DELAY

- STATE** Activating/deactivating the moving delay simulation.
IEC/IEEE-bus command : SOUR:FSIM:MDEL:STAT ON | OFF
- IGNORE RF CHANGES < 5%** When switched on, frequency variations below 5% are ignored. RF hopping is thus faster than 3 ms. IEC/IEEE-bus command : SOUR:FSIM:IGN:RFCH ON
- STANDARD** Is now the same as SET DEFAULT.

SET DEFAULT ►	Sets the default setting of the path parameters. IEC/IEEE-bus command : SOUR : FSIM : MDEL : DEF
PATH	Indicates the paths for subsequent parameters. These parameters can be set individually for each path.
PATH LOSS	Entry value of attenuation in path for the reference. Value range: 0.0 to 50.0 dB. IEC/IEEE-bus command : SOUR : FSIM : MDEL : REF : LOSS 3
DELAY	Entry value of signal delay in the reference path. Value range: 0.0 to 1638 μ s. IEC/IEEE-bus command : SOUR : FSIM : MDEL : REF : DEL 14.5E-6
PATH LOSS	Entry value of attenuation in path for moving. Value range: 0.0 to 50.0 dB. IEC/IEEE-bus command : SOUR : FSIM : MDEL : MOV : LOSS 3
DELAY MEAN	Mean value of the moving path delay. See explanation above. Value range: 0.25 to 1637.8 μ s. IEC/IEEE-bus command : SOUR : FSIM : MDEL : MOV : DEL : MEAN 12.5E-6
DELAY VARIATION (PK-PK)	Range for delay variation for the moving path. The peak-peak value is set. See explanations above. Value range: 0.3 to 100 μ s. IEC/IEEE-bus command : SOUR : FSIM : MDEL : MOV : DEL : VAR 2.1E-6
VARIATION PERIOD	Speed of delay variation. After a VARIATION PERIOD has elapsed a complete cycle is swept. Only for the moving path. Value range: 10 to 500 s IEC/IEEE-bus command : SOUR : FSIM : MDEL : MOV : VPER 13.4

2.9.4.4 Menu BIRTH-DEATH

In the BIRTH-DEATH mode the Fading Simulator simulates the dynamic propagation conditions according to test case 3GPP, 25.104-320, Annex B4.

To do this, 2 paths are simulated which alternately appear (BIRTH) or disappear (DEATH) at random time positions. The time positions lie within a grid of [-5, -4, -3, -2, -1, 0, 1, 2, 3, 4, 5] μ s. After a presettable time (HOPPING DWELL) a path disappears from a grid position and re-appears at another randomly selected grid position. During this hop, the second path remains stable at its grid position. After a further HOPPING DWELL has elapsed, the second path changes its position and the first path remains at its position, etc. The two paths never appear at the same time position (see Fig. 2-44).

According to Annex B4, each path has the same attenuation and phase and no Doppler shift. However, this can be set in the menu BIRTH-DEATH for further tests. The dwell period of 191 ms (in line with 3GPP) can be varied between 100 ms and 5 s.

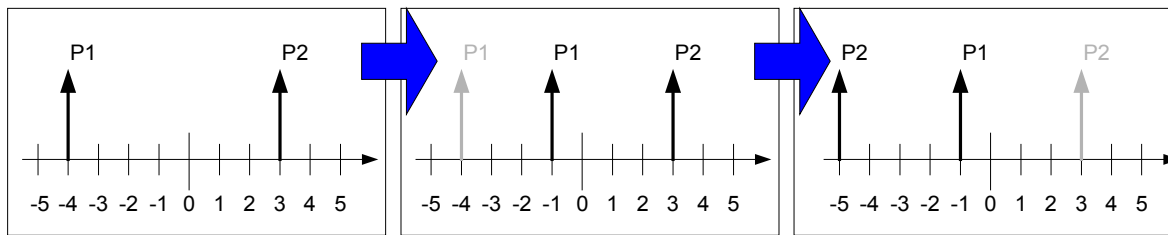

Fig. 2-44 Example of hop sequence with BIRTH-DEATH fading

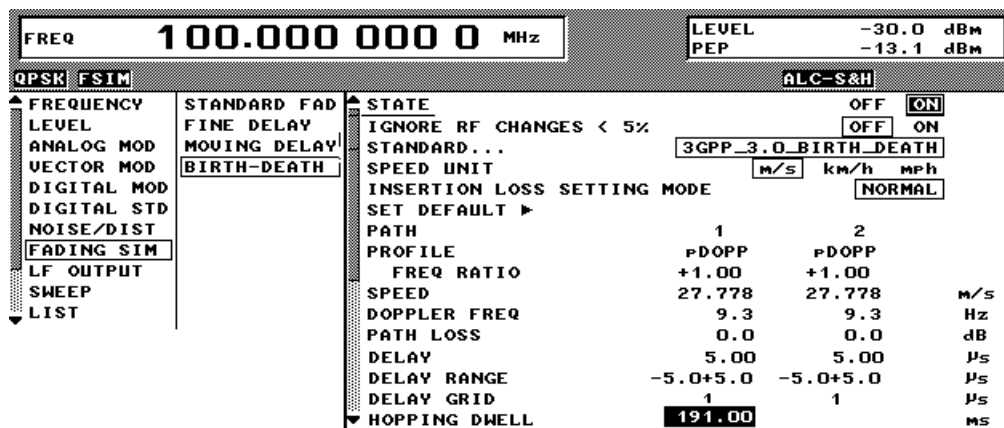

Fig. 2-45 Menu BIRTH-DEATH

- STATE** Activation/deactivation of the BIRTH-DEATH simulation.
IEC/IEEE-bus command : SOUR:FSIM:BIRT:STAT ON | OFF
- IGNORE RF CHANGES < 5%** ▶ When switched on, frequency variations below 5% are ignored. RF hopping is thus faster than 3 ms. IEC/IEEE-bus command : SOUR:FSIM:IGN:RFCH ON
- STANDARD** Is now the same as SET DEFAULT.
- SPEED UNIT** Selection of the unit required for the speed of parameter SPEED.
IEC/IEEE-bus command : SOUR:FSIM:BIRT:SPE:UNIT KMPH

INSERTION LOSS SETTING MODE	<p>Selection of a setting mode for the insertion loss of the fading simulator. See explanation under STANDARD FADING.</p> <p>IEC/IEEE-bus command : SOUR:FSIM:BIRT:ILOS:MODE NORM : SOUR:FSIM:BIRT:ILOS:MODE LACP</p>
SET DEFAULT ►	<p>Sets the default setting of the path parameters.</p> <p>IEC/IEEE-bus command : SOUR:FSIM:BIRT:DEF</p>
PATH	<p>Indicates the paths for subsequent parameters. These parameters can be set individually for each path.</p>
PROFILE	<p>Selection of a fading profile. Only pDOPP is available here; when FREQ RATIO = 0 is set a "non-fading" path is obtained.</p> <p>pDOPP (pure DOPPLer) Simulation of a transmission path having a single direct connection from the transmitter to the moving receiver (discrete component). The Doppler frequency shift is determined by the parameters DOPPLER FREQ and FREQ RATIO.</p> <p>IEC/IEEE-bus command : SOUR:FSIM:BIRT:PATH1:PROF PDOP</p>
FREQ RATIO	<p>Entry value of ratio of actual Doppler frequency shift. See explanation under STANDARD FADING. When FREQ RATIO = 0 is set, a "non-fading" path is obtained.</p> <p>IEC/IEEE-bus command : SOUR:FSIM:BIRT:PATH1:FRAT 1</p>
SPEED	<p>Entry value of the speed v of the moving receiver. See explanations under STANDARD FADING. All entries in path 1 are copied for path 2.</p> <p>IEC/IEEE-bus command : SOUR:FSIM:BIRT:PATH1:SPE 100</p>
DOPPLER FREQ	<p>Entry value of the magnitude of the maximum Doppler frequency shift. See explanation under STANDARD FADING. All entries in path 1 are copied for path 2.</p> <p>IEC/IEEE-bus command : SOUR:FSIM:BIRT:PATH1:FDOP 92.3</p>
PATH LOSS	<p>Entry value of attenuation in path. Value range: 0.0 to 50.0 dB.</p> <p>IEC/IEEE-bus command : SOUR:FSIM:BIRT:PATH2:LOSS 3</p>
DELAY	<p>Entry value of signal delay in path 1. All entries in path 1 are copied for path 2. Value range: 5.0 to 1000.0 μs.</p> <p>IEC/IEEE-bus command : SOUR:FSIM:BIRT:PATH1:DEL 1000 E-3</p>
DELAY RANGE	<p>The delay of the two paths is within this range. Non-editable parameter. For the two channels: -5.0 to +5.0 μs.</p>
DELAY GRID	<p>Time grid of the different carriers appearing at random. The carriers have delays which lie within the DELAY RANGE and coincide with $n * \text{DELAY GRID}$ (with $n = -5$ to $+5$). Non-editable parameter. Value = 1 μs for the two channels.</p>
HOPPING DWELL	<p>Dwell period until the next BIRTH-DEATH action. After this dwell period the next path changes its delay at random. Value range: 100.0 to 5000.0 ms.</p> <p>IEC/IEEE-bus command : SOUR:FSIM:BIRT:PATH1:HOPP:DWEL 1.2</p>

2.9.5 Test procedure

The following settings can be used to demonstrate how Option SMIQB49 functions:

Settings on SMIQ

General

Frequency	30 MHz
Level	-10 dB

Digital Modulation (DIGITAL MOD)

STATE	ON
SOURCE	Data List
LIST	1000 0000 0000 0000 0000 0000 0000 0000 (32 bits)
MODULATION	ASK
SYMBOL RATE	1 000 000 sym/s

Fading Simulation

MOVING DELAY	ON
<i>Reference Path</i>	
Path Loss	0 dB
Delay	0 μ s
<i>Moving Path</i>	
Path Loss	6.0 dB
Delay Mean	5.0 μ s
Delay Variation	5.0 μ s
Variation Period	10.0 s

Settings on the oscilloscope (BW > 100 MHz)

Vertical	50 mV/div, at 50 Ω
Horizontal	2 μ s /div
Trigger level	100 mV

The test result shows a high pulse (about 150 mV), and next to it a pulse which is half as high and moves from one side to the other accordingly to the setting *Delay Variation* or *Variation Period*.

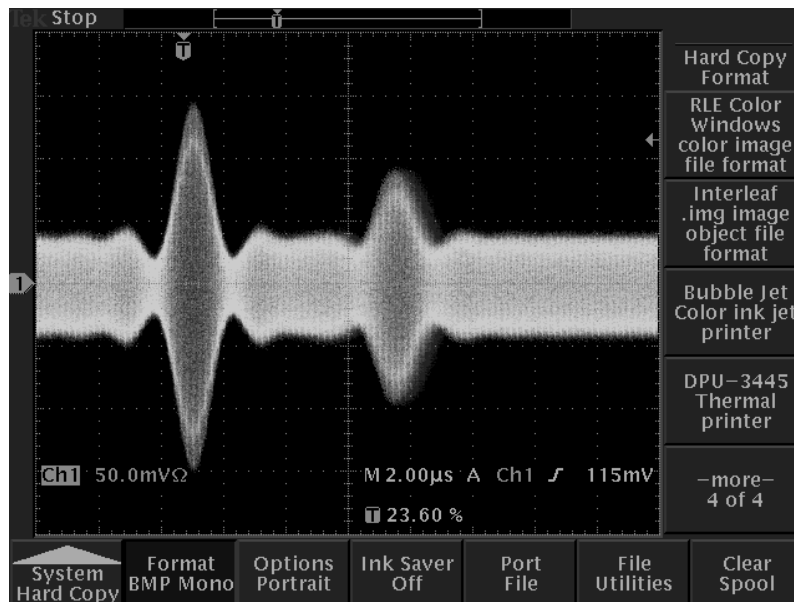

Fig. 2-46 Pulse on Oscilloscope

2.10 Digital Modulation

With option Modulation Coder (MCOD) SMIQB20 provided, SMIQ can generate digitally modulated output signals. Available modulation methods are ASK (amplitude shift keying), FSK (frequency shift keying), PSK (phase shift keying) as well as QAM (quadrature amplitude modulation). Baseband filtering and symbol rate can be freely set in a wide range.

The modulation coder generates the analog IQ signals for the I/Q modulator of SMIQ from the digital input signals.

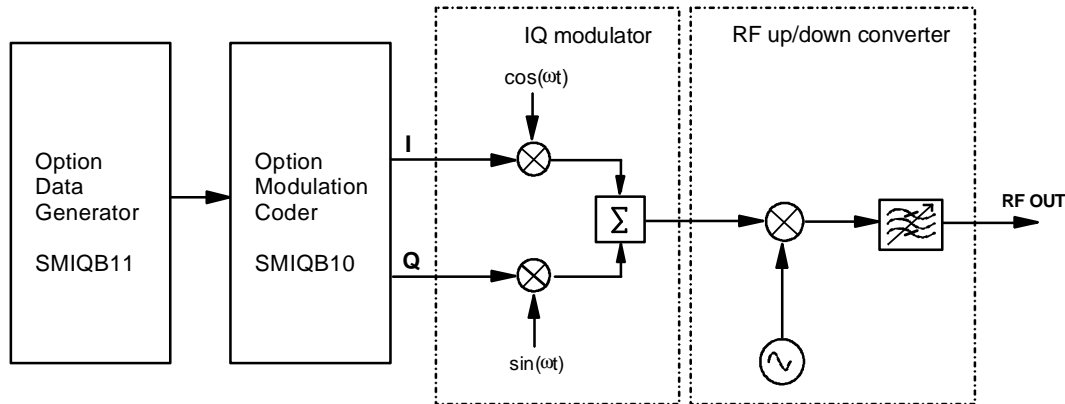

Fig. 2-47 Modulation coder in SMIQ

The modulation coder works with digital input signals such as

- clock signals (symbol clock, bit clock),
- modulation data or modulation symbols,
- control signals for envelope control and trigger signals.

The digital input signals may originate from the following sources:

- The modulation coder can generate clock signals such as PRBS data signals and simple data patterns.
- External clock signals, modulation data and signals for envelope control can be fed in via connectors at the front or rear panel of SMIQ.
- With option Data Generator SMIQB11 provided, an additional data source is available. This option has a 16-Mbit memory for modulation data and control signals. The memory can be extended to 48 Mbit or 80 Mbit by installing one or two SMIQB12 options (Memory Extension).

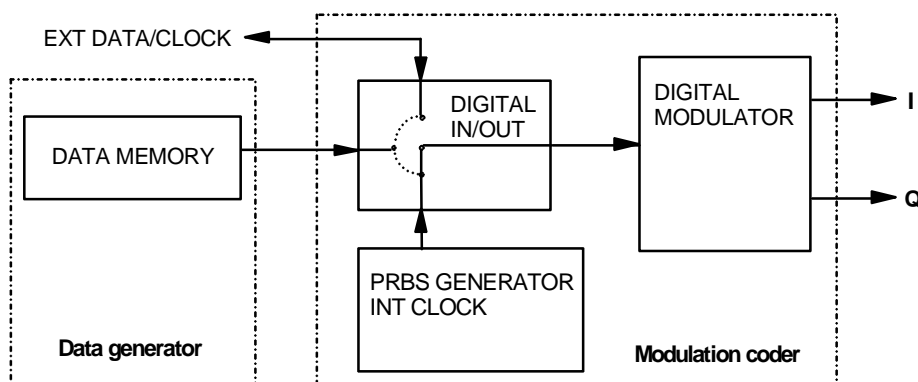

Fig. 2-48 Digital input signals of modulation coder

2.10.1 Digital Modulation Methods and Coding

The input sequence of modulation symbols d_n can be subject to different types of coding. I and Q values are assigned to the coded modulation symbols dc_n in the functional block MAPPING.

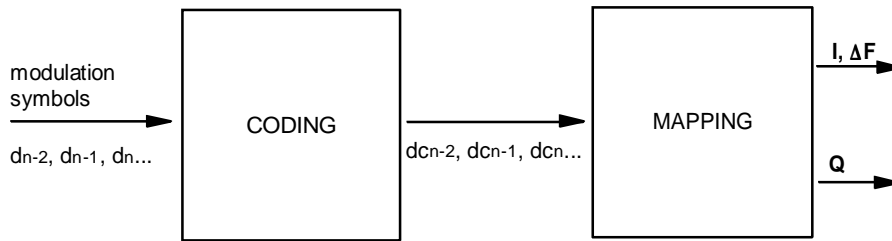

Fig. 2-49 Functional blocks Coding and Mapping

2.10.1.1 PSK and QAM Modulation

PSK and QAM modulations can be explained on the basis of a rule of assignment (mapping) according to which each modulation symbol is represented by I and Q values as shown in the following IQ constellation diagrams. The constellation diagrams apply if **no** coding is switched on.

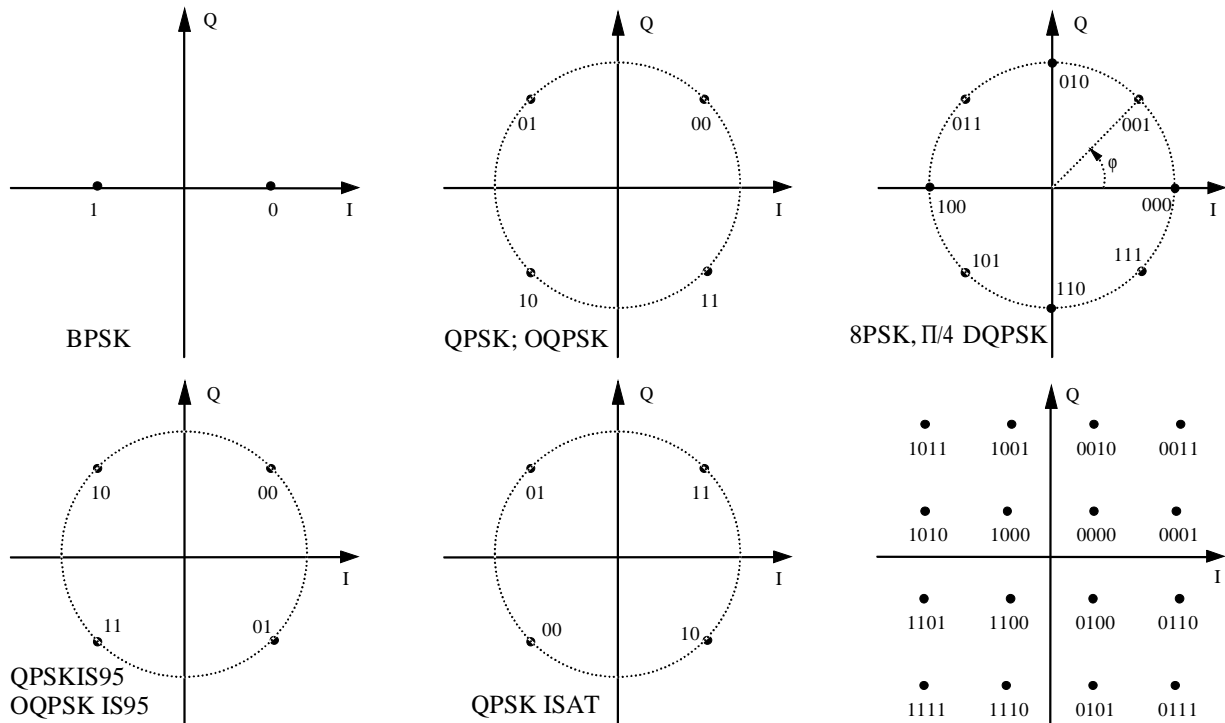

Fig. 2-50 Constellation diagrams of BPSK, QPSK, 8PSK and 16QAM

For offset QPSK (OQPSK), the Q signal is delayed by half the symbol period with reference to the I signal.

QAM modulation methods 16QAM, 32QAM, 64QAM and 256QAM were implemented according to ETSI standard ETS 300429 for Digital Video Broadcasting (DVB).

All PSK and QAM modulation methods can be combined with COS and SQR_COS baseband filters as well as with IS-95 filters. A combination with GAUSS and BESSEL filters is not possible.

2.10.1.2 Modulation $\pi/4$ DQPSK

With differential coding switched on at the same time, a constellation diagram is obtained for $\pi/4$ DQPSK which is similar to that obtained for 8PSK. Phase shifts are however assigned to the individual modulation symbols. The following tables show the assignment of modulation symbols to phase shifts of IQ vectors at the selected coding.

Table 2-4 Phase shifts for $\pi/4$ DQPSK without coding

Modulation symbol d_n (binary indication: MSB, LSB)	00	01	10	11
Phase shift ϕ	+ 45°	+135°	-135°	-45°

Table 2-5 Phase shifts for $\pi/4$ DQPSK with coding NADC, PDC, PHS, TETRA or APCO25

Modulation symbol d_n (binary display: MSB, LSB)	00	01	10	11
Phase shift ϕ	+ 45°	+135°	-45°	-135°

Table 2-6 Phase shifts for $\pi/4$ DQPSK with coding TFTS

Modulation symbol d_n (binary display: MSB, LSB)	00	01	10	11
Phase shift ϕ	- 135°	+135°	-45°	+45°

2.10.1.3 FSK Modulation

For FSK modulation, frequency shifts are assigned to the modulation symbols. The modulation index h of this digital frequency modulation is determined by

$$h = 2 \cdot \Delta f / f_{\text{Symb}}$$

The symbol rate f_{SYMB} can be freely set to a maximum of 2.5 Msymb/s for all FSK modulations. With GMSK selected, the frequency deviation Δf (FSK deviation) cannot be set since the modulation index is fixed to a value of $h = 0.5$. The following table shows the assignment of modulation symbols and frequency deviations for the different FSK methods.

Table 2-7 Frequency deviations for FSK methods

Mod. symbol	2FSK, GFSK	MSK, GMSK	4FSK	APCO
0	$-\Delta f$	$-\Delta f$	$-\Delta f$	$+\Delta f/3$
1	$+\Delta f$	$+\Delta f$	$-\Delta f/3$	$+\Delta f$
10	-	-	$+\Delta f/3$	$-\Delta f/3$
11	-	-	$+\Delta f$	$-\Delta f$

All FSK modulation methods can be combined with COS, SQR_COS, GAUSS and BESSEL baseband filters. A combination with IS-95 filters is not permissible.

2.10.1.4 Coding

Modulation symbols are coded directly before an assignment of I and Q values or frequency shifts. Coding is thus directly related with modulation methods which is the reason why codings are not freely combinable with modulation methods. The following table shows which combinations are possible.

Table 2-8 Possible combination of modulation method and coding

Coding	Selection CODING	Combinable with MOD TYPE	Example of use
Differential coding	DIFF	all except for 256QAM	
Gray + differential coding	GRAY+DIFF	all except for 256QAM	D8PSK for VDR
GSM differential coding	GSM	FSK, GFSK, GMSK	Mobile radio standard GSM
$\pi/4$ DQPSK differential coding	NADC; PDC;..	$\pi/4$ DQPSK	Mobile radio standards NADC, PDC, PHS, APCO25, TFTS, TETRA
Phase differential coding	INMARSAT	QPSK ISAT	Satellite system INMARSAT-M
Phase differential coding	PHASE DIFF	16 , 32 , 64 , 256 QAM	DVB in line with ETS 300429
VDL coding	VDL	8PSK	VHF Digital Link

The effect of differential coding on $\pi/4$ DQPSK has been described in section 'Modulation $\pi/4$ DQPSK'. Common coding types are listed in the following table.

Table 2-9 Coding algorithms

CODING	Coding algorithm	Applicable for K bit/symbol
NONE	$dc_n = d_n$	K = 1 to 8
DIFF	$dc_n = (d_n + dc_{n-1}) \text{ modulo } 2k$	K = 1 to 7
GRAY+DIFF	Gray coding with additional differential coding	K = 1 to 7
GSM	$dc_n = \text{not}(d_n \text{ exor } d_{n-1})$	K = 1
VDL	VDL standard	K = 3

Example 1: Differential coding for QPSK modulation with K = 2 bit/symbol
 Decimal display; value range for modulation symbols
 $d_n \in \{0;1;2;3\}$

Recursive coding is defined as follows: $dc_n = (d_n + dc_{n-1}) \text{ modulo } 4$.

Depending on the state of a preceding modulation symbol dc_{n-1} the coded modulation symbol dc_n is obtained for example from a modulation symbol $d_n = 2$ as follows:

$d_n = 2$	dc_{n-1}	dc_n
	0	2
	1	3
	2	0
	3	1

By means of differential coding, the assignment between modulation symbols and phase differences shown in the following table is generated:

Modulation symbol d_n (binary, MSB, LSB)	00	01	10	11
Phase difference $\Delta\varphi$	0°	90°	180°	270°

Example 2: Gray and differential coding for 8PSK modulation
 First, a gray coding is performed according to the gray code. Afterwards, a differential coding is performed according to the recursive coding algorithm quoted above. By means of the mapping rule shown in the figure in Section 'PSK and QAM Modulation' above, IQ values are assigned to the re-coded modulation symbols. In summary, the assignment between modulation symbols and phase differences shown in the following table is generated:

Modulation symbol d_n (binary, MSB, LSB)	000	001	010	011	100	101	110	111
Phase difference $\Delta\varphi$	0°	45°	135°	90°	270°	315°	225°	180°

Differential coding according to VDL is shown in the following table:

Modulation symbol d_n (binary, MSB, LSB)	000	001	010	011	100	101	110	111
Phase difference $\Delta\varphi$	0°	45°	135°	90°	315°	270°	180°	225°

Phase differential coding INMARSAT and PHASE DIFF correspond to system standards Inmarsat-M and DVB according to ETS 300 429. The INMARSAT coding can generally be used for modulation types with 2 bit/symbol, such as QPSK. It uses the following algorithm.

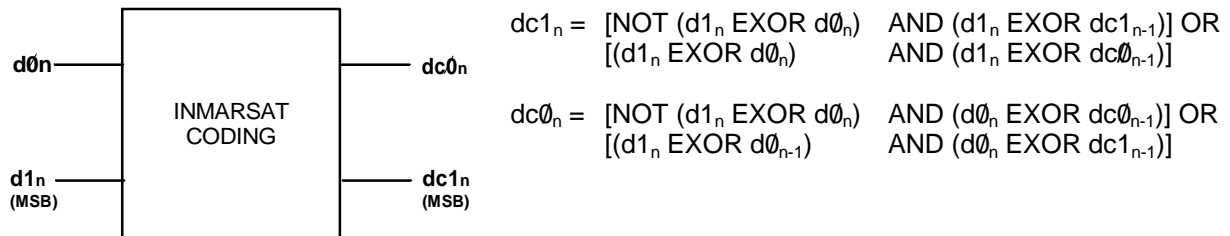

2.10.1.5 Setting Conflicts

As already mentioned in the previous sections, the combination of the above modulation methods with modulation parameters such as symbol rate, filtering and coding is limited. This limitation inevitably causes setting conflicts if a parameter is changed which would lead to an impermissible combination.

Table 2-10 Examples of settings conflicts

	Original status	Change by selection	Conflict	Solution
1	MOD TYPE $\pi/4$ DQPSK SYMBOL RATE 10 Msymb/s	MOD TYPE → GMSK	GMSK is only possible for symbol rates up to 7.5 Msymb/s.	Reduction of symbol rate to a value of <7.5 MHz.
2	MOD TYPE 2FSK FILTER GAUSS FILTER PARAMETER 1.0	FILTER → COS	Filter COS 1.0 not possible, the maximum roll-off factor is 0.7.	Setting of FILTER PARAMETER to a value between 0.15 and 0.7.
3	SYMBOL RATE 270 ksymb/s POWER RAMP INT	SYMBOL RATE → 5 Msymb/s	Envelope control is only possible for symbol rates up to 2.5 Msymb/s.	Switch-off of envelope control.

If SMIQ cannot resolve a setting conflict, error message SETTINGS CONFLICT is indicated in the status line of the display. In this case, SMIQ uses the user-defined setting in the display. However, the generated modulation signal does not correspond to this indication. The setting conflict can be eliminated by a change of parameters. Error message SETTINGS CONFLICT disappears as soon as a conflict-free setting is reinstated. For a list of possible setting conflicts and error messages for digital modulation see Annex B, thumbnail divider 7.

2.10.2 Internal Modulation Data and Control Signals from Lists

If SMIQ is equipped with option Data Generator SMIQB11, modulation data and control signals can be stored in a freely programmable data-generator memory. The storage capacity in the basic configuration is 16 Mbit but can be extended by 32 Mbit or 64 Mbit by fitting one or two SMIQB12 options.

The data are managed via so-called lists. 125 lists can be stored at maximum for modulation data or control signals. A list editor allows to select, copy, change and delete data lists. For a detailed description of the list editor see Section 2.2.11, List Editor.

There are two types of lists, the DATA LIST and the CONTROL LIST.

Lists, as a source for modulation data, can be selected in the menu by entering SOURCE -SOURCE-DATA_LIST and the active list by SOURCE-SELECT DATA LIST.

Lists, as a source for control signals, can be selected in the menu by entering SOURCE -CONTROL STATE ON and the active list by SOURCE-SELECT CONTROL LIST.

Note: *With DATA LIST selected as a source for internal modulation data, the control signals too have to come from a list. In this case, the setting POWER RAMP CONTROL- SOURCE EXTERN DIGITAL issues an error message*
With CONTROL LIST selected as a source for control signals, the modulation data too have to come from a list.

Data Lists:

The DATA LIST has a bit-by-bit layout. The length of the programmed data sequence and the available storage capacity are indicated in the status line of the display.

```

SELECT LIST...                               DLIST0
EDIT DATA LIST...
-BIT-----DATA-----
00000001      1010 1110 0011 1011 1101 1111 1110 1100
00000033      0100 1010 1001 0101 1110 1011 1011 0010
00000065      0000 1001 1110 0001 0101 0101 0010 1011
00000097      1111 0110 1110 1000 1101 0100 1100 0100
00000129      1001 0111 0100 0001 0010 1110 1110 1010
00000161      1101 0110 1111 0111 1111 1111 1000 0100
00000193      0000 0010 1000 0001 1111 0101 1101 0101
00000225      0110 0111 1100 0000 0111 1111 1111 1111

```

Fig. 2-51 DATA LIST for modulation data

Control Lists:

A CONTROL LIST can be created to generate control signals that have to be synchronous to the modulation symbols. The CONTROL LIST has a bit-by-bit layout. Six different control signals can be freely programmed. The CONTROL LIST can be created such that entries are only made at those symbol positions where a control signal is changed. The length of the CONTROL LIST is determined by the symbol number of the last entry and can differ from that of the DATA LIST.

SELECT LIST...	CLIST0					
EDIT CONTROL LIST	COPY DELETE EDIT VIEW					
-SYMBOL-----	BGATE	LATT	CW	HOP	TRIG2	TRIG1
00000001	1	0	0	0	0	1
00000157	1	1	0	0	1	0
00000313	0	1	0	0	0	0
00001249	0	1	0	1	0	0
00001250	0	1	0	0	0	0

Fig. 2-52 CONTROL LIST for control signals

Signals BGATE (Burst Gate) and LATT (Level Attenuation) are used for envelope control. Envelope control with these signals is switched on by selecting SOURCE-CONTROL STATE ON and POWER RAMP CONTROL - SOURCE INT.

Digital modulation can be switched off by the CW (Continuous Wave) signal. HOP (Hopping) is a trigger signal for frequency hopping (compare with section 'List Mode').

TRIG 1 and TRIG 2 (Trigger Output 1 and 2) can be used to generate synchronization signals such as frame clocks, start markers of a PRBS sequence or a special modulation symbol.

Signals BGATE, LATT, HOP and CW are used internally by SMIQ but not signals TRIG 1 and TRIG 2. All the control signals are available at the PAR DATA interface at the rear of SMIQ.

The data sequences stored in the data generator can be run repetitively (TRIGGER MODE AUTO). Moreover, trigger signals can be used for synchronized sequences. Trigger signals can be fed in via the TRIGIN input at connector PAR DATA. A trigger event can be initiated manually by EXECUTE TRIGGER. A trigger signal is generated upon the trigger event at the output TRIGOUT 3.

After a trigger event, the data generator starts to output modulation data from the active list starting with bit 1. In case of external triggering, the start can be delayed by a selectable number of symbols (EXT TRIGGER DELAY). Retriggering (RETRIG) can be inhibited for a selectable number of symbols (EXT TRIGGER INHIBIT).

2.10.3 Internal PRBS Data and Pattern

The PRBS generators in the modulation coder provide pseudo random binary sequences (PRBS) of different length and period. They are called sequences of maximum length and are generated by means of feedback shift registers.

The following schematic shows the 9-bit generator with feedback from registers 4 and 0 (output).

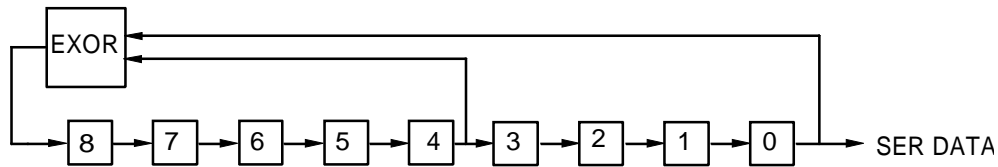

Fig. 2-53 9-bit PRBS generator

The pseudo random sequence of a PRBS generator is determined by the number of registers and the feedback. The following table describes all available PRBS generators:

Table 2-11 PRBS generators of modulation coder

PRBS generator	Length in bit	Feedback to
9 Bit	$2^9 - 1 = 511$	Register 4, 0
15 Bit	$2^{15} - 1 = 32767$	Register 1, 0
16 Bit	$2^{16} - 1 = 65535$	Register 5, 3, 2, 0
20 Bit	$2^{20} - 1 = 1048575$	Register 3, 0
21 Bit	$2^{21} - 1 = 2097151$	Register 2, 0
23 Bit	$2^{23} - 1 = 8388607$	Register 5, 0

PRBS data as a source for modulation data are selected in the menu via SOURCE - SOURCE PRBS. The period is determined by PRBS LENGTH.

Other internal modulation data are available as simple data patterns such as 0s or 1s. Selection is via SOURCE - SOURCE PATTERN.

Note: With PRBS data or Pattern selected as source for modulation data, only external control signals can be used. A combination with control signals from lists is not possible.

2.10.4 Digital Data and Clock output Signals

2.10.4.1 Serial Interfaces DATA, BIT CLOCK and SYMBOL CLOCK

The following figure shows an example for the output signals at the serial interface for QPSK modulation (2 bits per symbol). A positive CLOCK EDGE is assumed to be set. The following list containing 4 symbols (8 bits) was used as a data source.

```

SELECT LIST...                               DLIST00
EDIT DATA LIST...
-BIT-----DATA-----
00000001      0001 1011
    
```

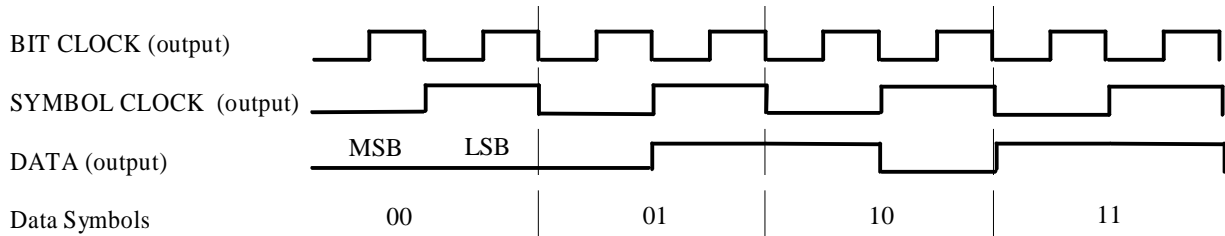

2.10.4.2 Parallel Interfaces DATA and SYMBOL CLOCK

The following figure shows an example for the output signals at the parallel interface. A positive CLOCK EDGE is assumed to be set.

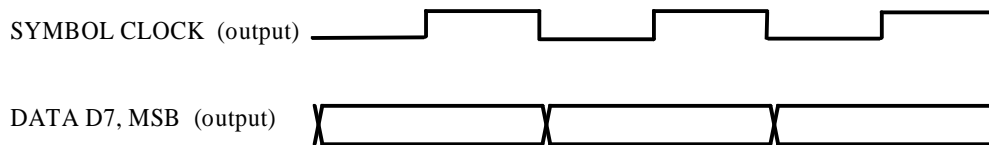

2.10.5 External Modulation Data and Control Signals

Digital modulation signals such as data, clock and signals for envelope control can be externally applied to the modulation coder either via the parallel PAR DATA interface at the rear of SMIQ or via the serial interface with BNC connectors DATA, BIT CLOCK and SYMBOL CLOCK. Moreover, the asynchronous serial interface SERDATA can be used. For a detailed description of the interface hardware see Section Elements at the Rear Panel".

The data source is selected in menu DIGITAL MOD - SOURCE. The clock source is selected in menu DIGITAL MOD - CLOCK irrespective of the data source selection. The polarity of the active clock edge can be changed via DIGITAL MOD - EXT INPUTS - CLOCK SLOPE.

2.10.5.1 External Serial Modulation Data

Serial modulation data can be fed bit-by-bit via connector DATA. For modulation types with more than 1 bit/symbol, the MSB is applied first (MSB first). Either an external bit clock or symbol clock or the internal clock can be used. The symbol clock serves as strobe to mark the LSB of a symbol. If an external bit clock is applied, the data at the active clock edges have to be in a stable state. With external symbol clock, the bit clock for reading the data is internally generated in the modulation coder (internal data clock). The following figures show the timing at the interface. In all the cases shown, the active clock edge is assumed to be positive.

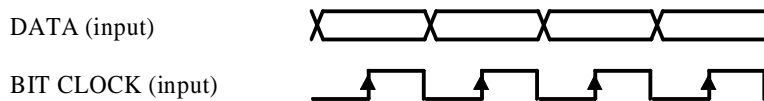

Fig. 2-54 External serial data and bit clock
Data change should take place only on the negative clock edge.

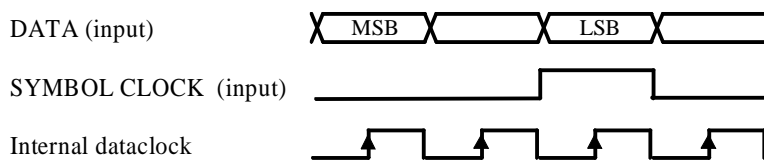

Fig. 2-55 External serial data and symbol clock, 3 bit/symbol
SYMBOL CLOCK = High marks the LSB. A status change of DATA and SYMBOL CLOCK should be performed synchronously.

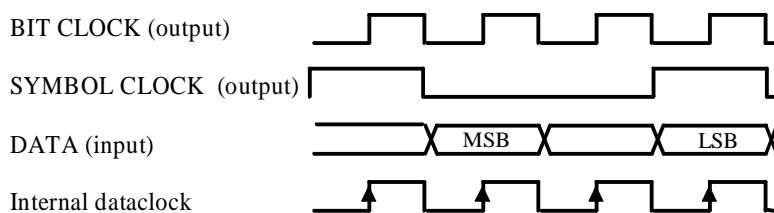

Fig. 2-56 External serial data, internal clock signals

External serial modulation data is selected in the menu by SOURCE-SOURCE-EXT_SER.

2.10.5.2 External Parallel Modulation Data

Parallel data can be fed as symbols via the PAR DATA interface (DATA-D7, -D6 to D0). Either an external symbol clock (SYMBCLK) or the internal symbol clock can be used. The data at the active edge of the symbol clock have to be in a stable state. The following figures show the timings at the interface. In the two examples shown below, the active clock edge is assumed to be positive.

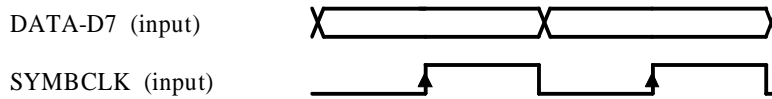

Fig. 2-57 External parallel data and symbol clock
Data change should take place only on the negative clock edge.

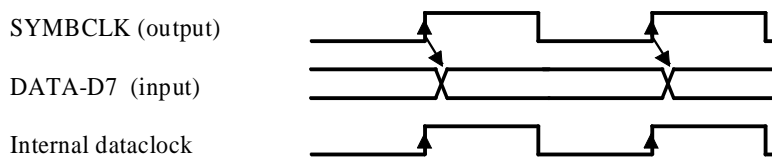

Fig. 2-58 External parallel data and symbol clock
SYMBOL CLOCK = High marks the LSB. A status change of DATA and SYMBOL CLOCK should be performed synchronously.

External serial modulation data is selected in the menu by SOURCE-SOURCE-EXT_SER.

For modulation types with less than 8 bit/symbol, line DATA-D7 is always the MSB. For QPSK modulation, for example (2 bit/symbol), data lines DATA-D7 and DATA-D6 are used.

Note: *BITCLK pin on the PARDATA interface is an output. Synchronization to an external bit clock is not possible in this mode.*

External parallel modulation data is selected in the menu by SOURCE-SOURCE-EXT_PAR.

2.10.5.3 Asynchronous Interface for External Modulation Data

The SERDATA interface on the rear of SMIQ serves for the asynchronous serial transmission of modulation data. The characteristics of this RS-232-C interface is described in Annex A.

For a defined start with specific modulation data it has to be made sure that the backup memories in the RS-232 transmitter and receiver are deleted. The following setting sequence in the menu is required:

1. Carry out desired settings for digital modulation in menu.
2. Select data source SERDATA using SOURCE - SOURCE SERDATA.
3. Make connection to external data source, but do not yet start external data source.
4. Switch off digital modulation using STATE OFF.
5. Set TRIGGER MODE ARMED_AUTO.
In this state, SMIQ is ready for reception, but discards data that are read in via SERDATA.
6. Switch on digital modulation with STATE ON.
7. Start external data source.
The read-in data are written into the receiving buffer. Only if this buffer is filled can SMIQ react to a trigger event.
8. Activate trigger event to start digital modulation.

Note: *The baud rate has to be selected at least 25% higher than the bit rate of the digital modulation. If SMIQ has not enough data, the error message "Data underrun" will be issued in the status line.*

2.10.5.4 External Control Signals

The external control signals for envelope control BURST GATE and LEV ATT can be applied via the SERDATA interface at the rear of SMIQ. The signal for CW control can also be applied to this interface.

Note: *The use of control signals from lists in combination with external modulation data is not possible.*

2.10.6 Envelope Control

For TDMA radio networks, in addition to digital modulation, a time-synchronous control of the envelope of the RF output signal is required. To this effect, SMIQ is equipped with an analog envelope modulator which can be driven via connector POWER RAMP. Instead of the analog control signal the digital signals BURST GATE and LEV ATT can be used to control the envelope modulator. In the modulation coder, a ramp with settable slope is obtained from data changes from high→low or low→high of the digital BURST GATE signal. The resulting analog signal is taken to the envelope modulator and is provided at connector POWER RAMP. The LEV ATT signal serves for a defined level reduction.

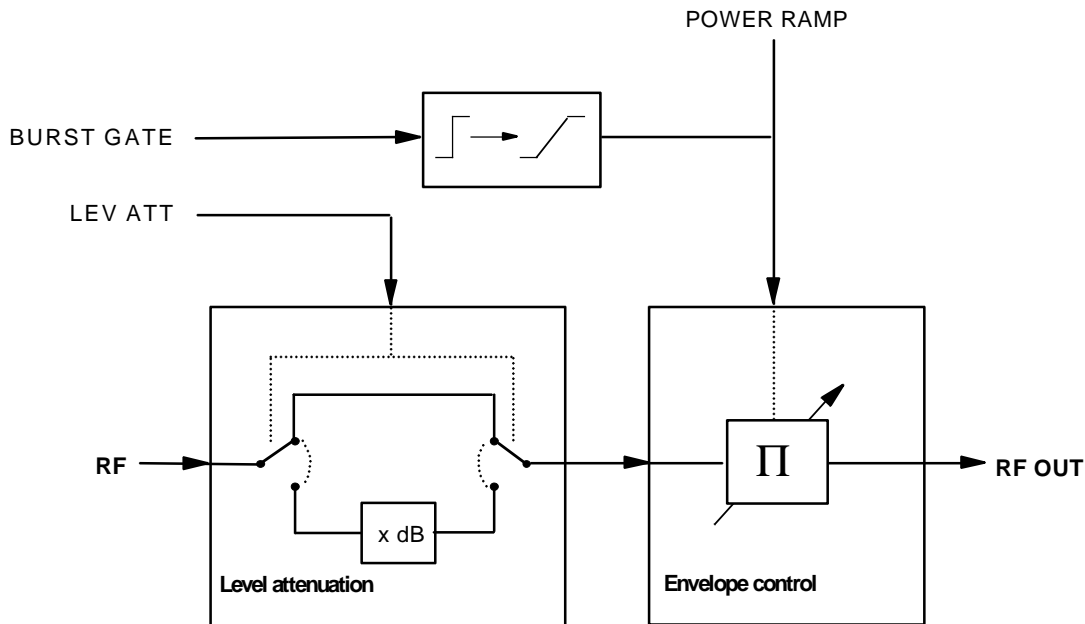

Fig. 2-59 Envelope control in SMIQ with modulation coder

The digital envelope control signals can be fed in externally via connector PAR DATA. With option Data Generator SMIQB11 provided, the signals can also be generated internally by programming them in the CONTROL LIST (see Section "Modulation Data from Lists").

The following table shows the logic function of the two signals BURST GATE and LEV ATT.

Table 2-12 Logic function of signals BURST GATE and LEVEL ATT

BURST GATE	LEV ATT	Remark
1	0	Full level
1	1	Level reduced by the value set in dB under POWER RAMP CONTROL - ATTENUATION
0	X	Maximum level reduction

The following figure illustrates the effect of the envelope control signals.

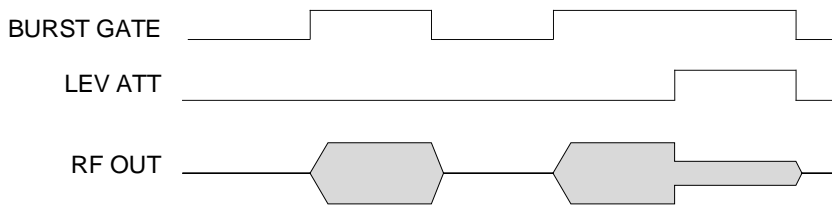

Fig. 2-60 Signal waveforms during envelope control

Note: Envelope control with digital input signals and edge shaping is only possible for symbol rates of maximum 2.5 Msymb/s.

Envelope control is switched on in the menu via:

analog POWER RAMP CONTROL - SOURCE - EXT ANALOG.

external digital POWER RAMP CONTROL - SOURCE - EXT DIGITAL.

internal digital POWER RAMP CONTROL - SOURCE - INT and SOURCE CONTROL STATE ON.

2.10.7 Clock Signals

The symbol clock and the bit clock are generated in SMIQ by a clock synthesizer on the modulation coder. All clock signals are synchronized to the 10 MHz reference of the unit. The symbol clock is available at the SYMBOL CLOCK connector and the bit clock at the BIT CLOCK connector. If required, the clock synthesizer in SMIQ can synchronize to an externally applied symbol or bit clock.

Only during an operation with external parallel data is synchronization to one symbol clock possible. This symbol clock is applied via the PAR DATA interface. In all other cases, apply symbol and bit clock to the corresponding BNC connector.

The clock signal is selected in the menu via CLOCK-MODE SYMBOL/BIT and CLOCK-CLOCK SOURCE EXT.

To allow for a trouble-free synchronization of the clock synthesizer first apply the external clock and set the correct symbol rate at SMIQ. Then switch CLOCK SOURCE from INT to EXT.

Notes: *The set symbol rate should not differ by more than 1% from the symbol rate of the external signal.*

2.10.8 RF Level For Digital Modulation

With modulation switched on, a level display divided in half appears in the header of the display. The peak envelope power (PEP) of the modulated RF output level is displayed in addition to average power (LEVEL).

The difference between PEP and LEVEL depends on the modulation type and the filtering. The power of QAM signals is calculated on the assumption of a uniform distribution of modulation symbols. For the PEP calculation, it is always assumed that the most unfavourable case occurs in the sequence of modulation data. This is definitely the case for PRBS data with a long period (eg PRBS LENGTH 23 bit). For other data sequences it is possible that the indicated PEP is not attained.

2.10.9 Digital Modulation Menu

The DIGITAL MOD menu provides access to digital modulation settings.

Menu selection: DIGITAL MOD



Fig. 2-61 DIGITAL MOD menu, SMIQ equipped with option Modulation Coder SMIQB20 and option Data Generator SMIQB11

STATE Switch on/off of digital modulation.
IEC/IEEE-bus command SOUR:DM:STAT ON

SOURCE... Opens a window for defining the data source for digital modulation.
Menu selection depends on option SMIQB11. If option SMIQB11 is installed, the menu provides more selections and settings for modulation data from lists.

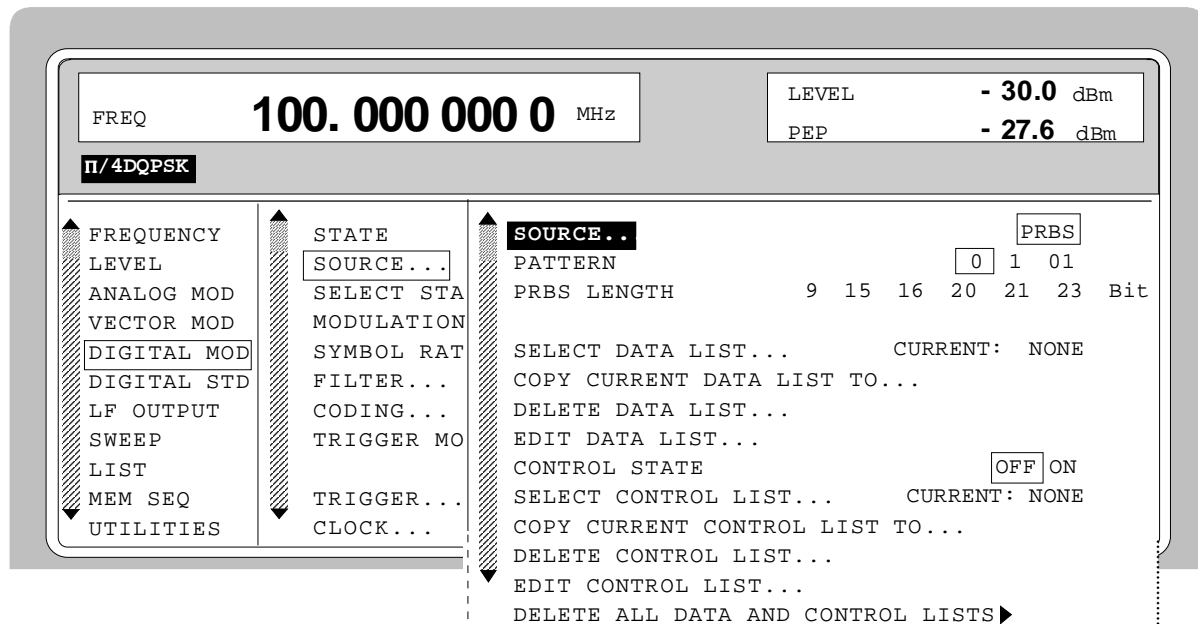

Fig. 2-62 DIGITAL MOD-SOURCE menu, SMIQ equipped with option Modulation Coder SMIQB20 and option Data Generator SMIQB11

(SOURCE...)	SOURCE...	Opens a window for selecting the source for modulation data.
	EXT_PAR	The modulation data are fed in via the parallel PAR DATA interface at the rear of SMIQ. IEC -bus : SOUR:DM:SOUR PAR
	EXT_SER	The modulation data are fed in serially at input DATA. IEC -bus : SOUR:DM:SOUR SER
	PATTERN	A simple data pattern is continuously generated. IEC -bus : SOUR:DM:SOUR PATT
	PRBS	A pseudo random bit sequence is generated and continuously repeated. IEC -bus : SOUR:DM:SOUR PRBS
	SERDATA	The modulation data are fed in via the asynchronous SER_DATA interface. IEC -bus : SOUR:DM:SOUR SDAT
	DATA LIST	Modulation data from lists IEC -bus : SOUR:DM:SOUR DLIS
	PATTERN	Selection of a simple data pattern which is continuously generated.
	0	0s are continuously generated. IEC -bus : SOUR:DM:PATT ZERO
	1	1s are continuously generated. IEC -bus : SOUR:DM:PATT ONE
	01	010 data changes are continuously generated. IEC -bus : SOUR:DM:PATT ALT
	PRBS LENGTH	Setting of PRBS generator length. 9 bit, 15 bit, 16 bit, 20 bit, 21 bit and 23 bit can be selected. The period of the data sequence is then between 2^9-1 and $2^{23}-1$ bit (see Section 2.10.3 "Internal PRBS Data and Pattern"). IEC/IEEE-bus command : SOUR:DM:PRBS 15
	SELECT DATA LIST	Opens a window for selecting a stored data list or for generating a new list. IEC/IEEE-bus : SOUR:DM:DLIS:SEL `name`
	COPY CURRENT DATA LIST TO	Stores the current data list under a different name. IEC/IEEE-bus : SOUR:DM:DLIS:COPY `name`
	DELETE DATA LIST	Deletes a data list.

(SOURCE...)	EDIT DATA LIST	<p>Opens a window for editing a data list bit-by-bit. The available storage capacity and the length of the current list is displayed in parameters FREE and LEN (see also Section List Editor).</p> <p>COPY Copies a list range FILL Fills the range with filler pattern INSERT Inserts a list range at a different position of the list DELETE Deletes a list range EDIT/VIEW Edits or views the list</p>
	CONTROL STATE	<p>ON The signals from the selected CONTROL LIST are effective. OFF The signals are not effective IEC/IEEE-bus : SOUR : DM : CLIS : CONT ON</p>
	SELECT CONTROL LIST	<p>Opens a window for selecting a stored list for control signals or for generating a new list for control signals. IEC/IEEE-bus : SOUR : DM : CLIS : SEL 'name'</p>
	COPY CURRENT CONTROL LIST TO	<p>Stores the current list for control signals under a different name. IEC/IEEE-bus : SOUR : DM : CLIS : COPY 'name'</p>
	DELETE CONTROL LIST	<p>Deletes a list for control signals.</p>
	EDIT CONTROL LIST	<p>Opens a window for editing a list for control signals symbol-by-symbol. The available storage capacity and the length of the current list is displayed in parameters FREE and LEN (see also Section List Editor).</p> <p>COPY Copies a list range DELETE Deletes a list range EDIT/VIEW Edits or views the list</p>
	DELETE ALL DATA AND CONTROL LISTS ►	<p>Deletes all data lists and lists for control signals. IEC/IEEE-bus -</p>

SELECT STANDARD...

Opens a window for selecting the standard. After the selection, the modulation parameters MODULATION, SYMBOL RATE, FILTER and CODING are automatically adjusted to the standard. USER is indicated if the settings of these parameters do not correspond to the selected standard. The following standards are available:

APCO4FM	IEC\IEEE-bus command	: SOUR : DM : STAN APCF
APCOQPSK	IEC\IEEE-bus command	: SOUR : DM : STAN APCQ
ASK STD-T55	IEC\IEEE-bus command	: SOUR : DM : STAN ASK
BLUETOOTH	IEC\IEEE-bus command	: SOUR : DM : STAN BLU
CDPD	IEC\IEEE-bus command	: SOUR : DM : STAN CDPD
CT2	IEC\IEEE-bus command	: SOUR : DM : STAN CT2
DECT	IEC\IEEE-bus command	: SOUR : DM : STAN DECT
GSM	IEC\IEEE-bus command	: SOUR : DM : STAN GSM
GSM_EDGE	IEC\IEEE-bus command	: SOUR : DM : STAN GSME
IRIDIUM	IEC\IEEE-bus command	: SOUR : DM : STAN IRID
IS95 FWD	IEC\IEEE-bus command	: SOUR : DM : STAN FIS95
IS95 REV	IEC\IEEE-bus command	: SOUR : DM : STAN RIS95
NADC	IEC\IEEE-bus command	: SOUR : DM : STAN NADC
PDC	IEC\IEEE-bus command	: SOUR : DM : STAN PDC
PHS	IEC\IEEE-bus command	: SOUR : DM : STAN PHS
TETRA	IEC\IEEE-bus command	: SOUR : DM : STAN TETR
TFTS	IEC\IEEE-bus command	: SOUR : DM : STAN TFTS
PWT	IEC\IEEE-bus command	: SOUR : DM : STAN PWT
ICOBPSK	IEC\IEEE-bus command	: SOUR : DM : STAN ICQB
ICOGMSK	IEC\IEEE-bus command	: SOUR : DM : STAN ICQG
ICOQPSK	IEC\IEEE-bus command	: SOUR : DM : STAN ICQQ
WORLDSPACE	IEC\IEEE-bus command	: SOUR : DM : STAN WORL
	(only with option SMIQB17)	
WCDMA QPSK	IEC\IEEE-bus command	: SOUR : DM : STAN QWCD
	(only with option SMIQB47)	
ARIB STD-T55	IEC\IEEE-bus command	: SOUR : DM : STAN AT55

MODULATION...

Opens a window for defining the modulation method. Moreover, the number of bits per modulation symbol is displayed. See also Section "Digital Modulation Methods and Coding".

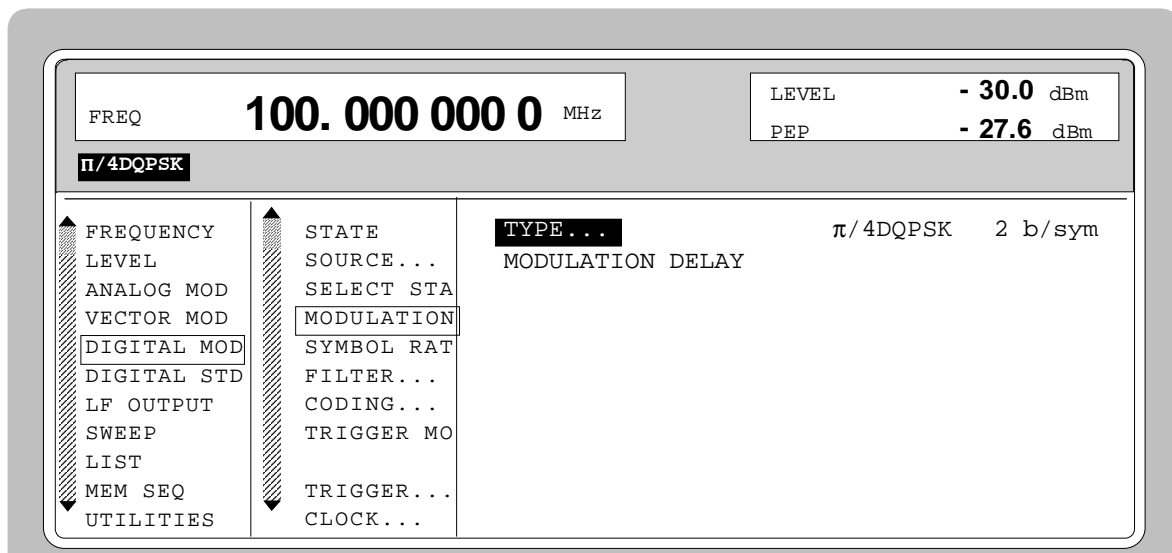

Fig. 2-63 DIGITAL MOD - MODULATION... menu, SMIQ equipped with option Modulation Coder SMIQB20 and option Data Generator SMIQB11

(MODULATION...)	TYPE...	
		Opens a window for selecting the modulation method. The following modulations can be selected. User-defined mapping lists can be loaded by IEC/IEEE-bus. Then they can be selected by their list name (cf. chapter 3, :SOURCE:DM:MLIST).
ASK	Amplitude Shift Keying	IEC/IEEE-bus :DM:FORM ASK
BPSK	Binary Phase Shift Keying	IEC/IEEE-bus :DM:FORM BPSK
QPSK	Quadrature Phase Shift Keying	IEC/IEEE-bus :DM:FORM QPSK
QPSK IS95	Quadrature Phase Shift Keying with a mapping according to Interim Standard 95 for CDMA	IEC/IEEE-bus :DM:FORM QIS95
QPSK ISAT	QPSK Modulation for INMARSAT-M	IEC/IEEE-bus :DM:FORM QINM
QPSK ICO	QPSK Modulation for ICO	IEC/IEEE-bus :DM:FORM QICO
WCDMA QPSK	QPSK Modulation for W-CDMA	IEC/IEEE-bus :DM:FORM QWCD
	WCDMA QPSK only with option SMIQB47	
OQPSK	Offset Quadrature Phase Shift Keying	IEC/IEEE-bus :DM:FORM OPSK
OQPSK IS95	Quadrature Phase Shift Keying with a mapping according to Interim Standard 95 for CDMA	IEC/IEEE-bus :DM:FORM OIS95
$\pi/4$ QPSK	QPSK with $\pi/4$ rotation for each symbol step (use: NSTAR)	IEC/IEEE-bus :DM:FORM P4QP
$\pi/4$ DQPSK	QPSK with differential coding	IEC/IEEE-bus :DM:FORM P4DQ
8PSK	Phase Shift Keying with 8 points in the constellation diagram	IEC/IEEE-bus :DM:FORM PSK8
8PSK EDGE	Phase Shift Keying with 8 points in the constellation diagram and $3\pi/8$ rotation per symbol.	IEC/IEEE-bus :DM:FORM PSKE8
GMSK	Gaussian Minimum Shift Keying	IEC/IEEE-bus :DM:FORM GMSK
GFSK	Gaussian filtered Frequency Shift Keying	IEC/IEEE-bus :DM:FORM GFSK
2FSK, 4FSK	Frequency Shift Keying	IEC/IEEE-bus :DM:FORM FSK2
4FSK APCO	Frequency Shift Keying according to APCO25	IEC/IEEE-bus :DM:FORM AFSK4
QAM	Quadrature Amplitude Modulation with 16, 32, 64 or 256 points in the constellation diagram	IEC/IEEE-bus :DM:FORM QAM16

- (MODULATION)** **FSK DEVIATION** Input value of deviation with FSK or GFSK selected.
 IEC/IEEE-bus : SOUR:DM:FSK:DEV 100 KHZ
- ASK DEPTH** Input value for ASK modulation depth.
 IEC/IEEE-bus : SOUR:DM:ASK:DEPT 10
- MODULATION DELAY** Value for time delay of digital modulation between data input/output and RF output of .
 IEC/IEEE-bus : SOUR:DM:MDEL?
- SYMBOL RATE** Input value of symbol rate.
 IEC/IEEE-bus command : SOUR:DM:SRAT 1.2288 MHZ
- FILTER...** Opens a window for setting the baseband filtering.

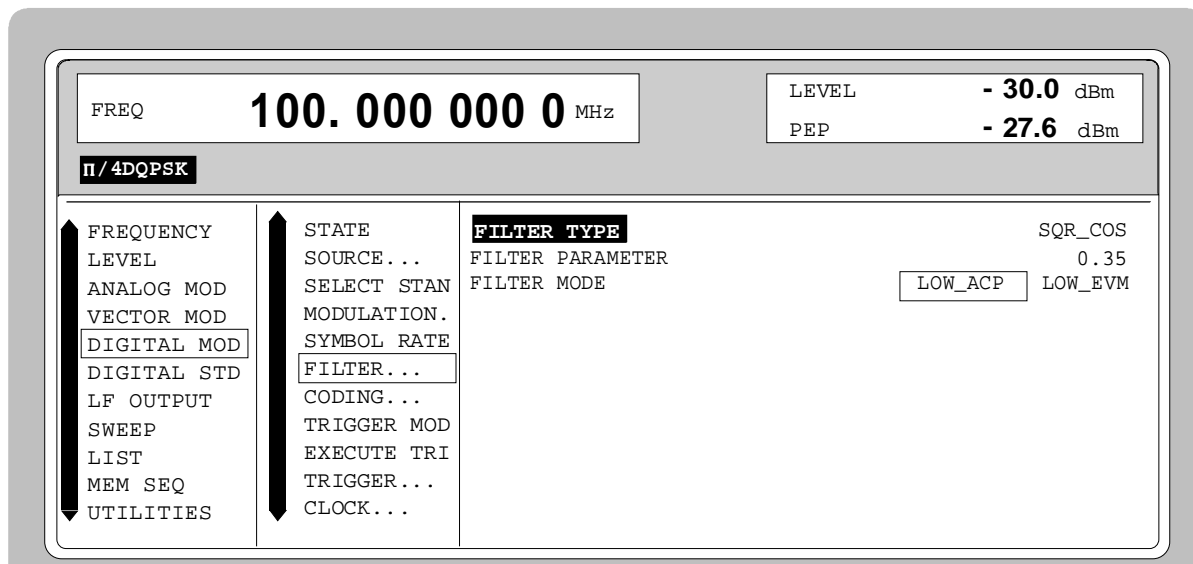

Fig. 2-64 DIGITAL MOD -FILTER... menu, SMIQ equipped with option Modulation Coder SMIQB20 and option Data Generator SMIQB11

(FILTER...)	FILTER TYPE	<p>Opens a window for selecting a type of filter. The following filters can be selected:</p> <p>SQR_COS Square Root RaisedCosine IEC : SOUR:DM:FILT:TYPE SCOS</p> <p>COS Cosine IEC : SOUR:DM:FILT:TYPE COS</p> <p>GAUSS Gaussian filter IEC : SOUR:DM:FILT:TYPE GAUS</p> <p>GAUSS LINEAR Linearized Gaussian filter for GSM_EDGE. IEC : SOUR:DM:FILT:TYPE LGA</p> <p>BESSEL Bessel filter with $B \times T = 1.25$ or 2.5 IEC : SOUR:DM:FILT:TYPE BESS1</p> <p>IS95 Filter for CDMA mobile station according to Interim Standard 95 IEC : SOUR:DM:FILT:TYPE IS95</p> <p>IS95 EQUAL Filter for CDMA base station with equalizer according to IS-95 IEC : SOUR:DM:FILT:TYPE EIS95</p> <p>APCO C4FM Cosine filter with $si(x)$-compensation according to APCO25 standard for 4FSK modulation. IEC : SOUR:DM:FILT:TYPE APCO</p> <p>TETRA Filter for PSK/QAM modulation. IEC : SOUR:DM:FILT:TYPE TETR</p> <p>WCDMA0.22 Filter for PSK modulation. Square Root Raised Cosine filter with Roll Off = 0.22, optimized for W-CDMA IEC : SOUR:DM:FILT:TYPE WCDM</p> <p>RECTANGLE Filter with a rectangular impulse answer of 1 symbol length. IEC : SOUR:DM:FILT:TYPE RECT</p> <p>SPLIT PHASE Filter for ASK modulation IEC : SOUR:DM:FILT:TYPE SPH</p> <p>USER User defined filter. The lists can be generated via :DM:FLIST:SEL and filled via :DM:FLIST:DATA. IEC : SOUR:DM:FILT:TYPE USER</p>								
	FILTER PARAMETER	<p>Opens a window for setting the filter parameter. The selection depends on the selected filter type:</p> <table border="0"> <thead> <tr> <th style="text-align: left;">Parameter</th> <th style="text-align: left;">Filter Type</th> </tr> </thead> <tbody> <tr> <td>Roll-off factor</td> <td>SQR COS, COS, or APCO:</td> </tr> <tr> <td>Normalized band width $B \times T_{\text{Symb}}$</td> <td>GAUSS .</td> </tr> <tr> <td>IEC/IEEE-bus</td> <td>: SOUR:DM:FILT:PAR 0.2</td> </tr> </tbody> </table>	Parameter	Filter Type	Roll-off factor	SQR COS, COS, or APCO:	Normalized band width $B \times T_{\text{Symb}}$	GAUSS .	IEC/IEEE-bus	: SOUR:DM:FILT:PAR 0.2
Parameter	Filter Type									
Roll-off factor	SQR COS, COS, or APCO:									
Normalized band width $B \times T_{\text{Symb}}$	GAUSS .									
IEC/IEEE-bus	: SOUR:DM:FILT:PAR 0.2									
	FILTER MODE	<p>Selection of filter mode.</p> <p>LOW_ACP Filter for minimum <u>A</u>djacent <u>C</u>hannel <u>P</u>ower IEEE : SOUR:DM:FILT:MODE LACP</p> <p>LOW_EVM Filter for minimum vector error IEEE : SOUR:DM:FILT:MODE LEVM</p>								

CODING...	Opens a window for setting the modulation coding. See also Section " Digital Modulation Methods and Coding. The following codings can be selected:
OFF	No coding IEC-bus command : SOUR:DM:COD OFF
DIFF	Differential coding IEC-bus command : SOUR:DM:COD DIFF
PHASE_DIFF	Phase differential coding IEC-bus command : SOUR:DM:COD DPHS
GRAY+DIFF	Gray and differential coding IEC-bus command : SOUR:DM:COD DGR
GSM	Differential coding according to GSM standard IEC-bus command : SOUR:DM:COD GSM
NADC	Differential coding for $\pi/4$ DQPSK according to NADC standard IEC-bus command : SOUR:DM:COD NADC
PDC	Differential coding according to PDC standard IEC-bus command : SOUR:DM:COD PDC
PHS	Differential coding according to PHS standard IEC-bus command : SOUR:DM:COD PHS
TETRA	Differential coding for $\pi/4$ DQPSK according to TETRA standard IEC-bus command : SOUR:DM:COD TETR
APCO25	Differential coding according to APCO25 standard IEC-bus command : SOUR:DM:COD APCO25
PWT	Differential coding for $\pi/4$ DQPSK according to PWT standard IEC-bus command : SOUR:DM:COD PWT
TFTS	Differential coding for $\pi/4$ DQPSK according to TFTS standard IEC-bus command : SOUR:DM:COD TFTS
INMARSAT	Phase differential coding for INMARSAT-M QPSK modulation IEC-bus command : SOUR:DM:COD INM
VDL	Differential coding according to VDL (VHF Digital Link) for 8PSK modulation. IEC-bus command : SOUR:DM:COD VDL

TRIGGER MODE	<p>Selection of trigger mode. This selection is only available when option SMIQB11 is installed.</p> <p>AUTO The data sequences from the selected DATA LIST and CONTROL LIST are continuously repeated. IEC/IEEE-bus command : SOUR:DM:SEQ AUTO</p> <p>RETRIG The data sequences are continuously repeated. A trigger event causes a restart from symbol 1. IEC/IEEE-bus command : SOUR:DM:SEQ RETR</p> <p>ARMED_AUTO A start of data sequences from symbol 1 is caused by a trigger event. The unit is then automatically set to AUTO and can no longer be triggered. IEC/IEEE-bus command : SOUR:DM:SEQ AAUT</p> <p>ARMED_RETRIG A start of data sequences from symbol 1 is only caused by a trigger event. The unit is then automatically set to RETRIG. Each new trigger event causes a restart of the data sequences. IEC/IEEE-bus command : SOUR:DM:SEQ ARET</p> <p>SINGLE A trigger event causes a single data sequence run. IEC/IEEE-bus command : SOUR:DM:SEQ SING</p>
---------------------	---

EXECUTE TRIGGER ▶ Executes a trigger event to start a data sequence.
IEC/IEEE-bus command : TRIG:DM:IMM

TRIGGER... Opens a window for setting the different types of trigger and for setting the time delay of the trigger signal. The menu is only available if SMIQ is equipped with option Data Generator SMIQB11.

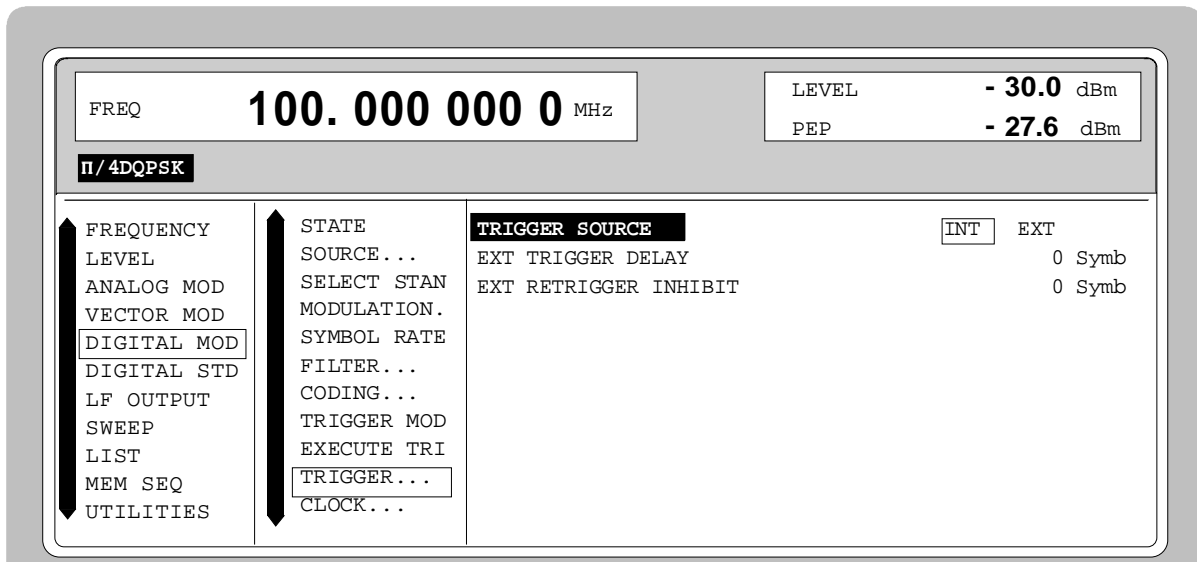

Fig. 2-65 DIGITAL MOD - TRIGGER menu, SMIQ equipped with option Modulation Coder SMIQB20 and option Data Generator SMIQB11

(TRIGGER...)	TRIGGER SOURCE	<p>Selection of trigger source</p> <p>EXT An external trigger signal can be fed in at TRIGIN of connector PAR DATA at the rear of SMIQ. With the active edge, a data sequence is started from the data generator memory.</p> <p>INT With INT selected, a trigger event can be manually executed by EXECUTE TRIGGER.</p> <p>IEC/IEEE-bus : SOUR:DM:TRIG:SOUR EXT</p>
	EXT TRIGGER DELAY	<p>Input value of number of symbols by which an external trigger signal is delayed before it starts the data sequence in the data generator. A synchronicity with the DUT or other units can thus be achieved.</p> <p>IEC/IEEE-bus : SOUR:DM:TRIG:DEL 3</p>
	EXT RETRIGGER INHIBIT	<p>Input of number of symbols for which each new trigger event is inhibited during MODE RETRIG after a trigger signal.</p> <p>During MODE RETRIG, each new trigger signal restarts the data sequence in the data generator. This restart can be inhibited for the entered number of symbols. The entry of 1250 symbols, for example, causes new trigger signals to be ignored for the duration of 1250 symbols after execution of a trigger event.</p> <p>IEC/IEEE-bus : SOUR:DM:TRIG:INH 1250</p>

CLOCK... Opens a window for selecting the clock source and for setting a delay.

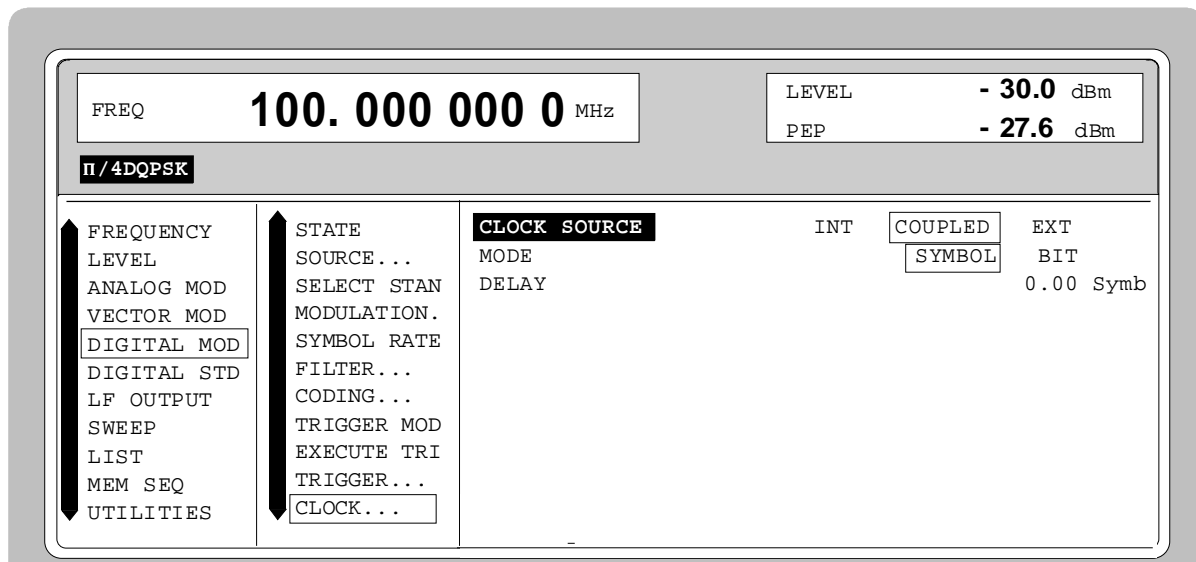

Fig. 2-66 DIGITAL MOD - CLOCK, SMIQ equipped with option Modulation Coder SMIQB20 and option Data Generator SMIQB11

(CLOCK...)	CLOCK SOURCE	<p>Selection of clock source</p> <p>INT The symbol and the bit clock in SMIQ are generated by a clock synthesizer on the modulation coder. All the clock signals are synchronized to the 10-MHz reference of the unit.</p> <p>IEEE-bus : SOUR:DM:CLOC:SOUR INT</p> <p>COUPLED The clock comes from the same source as the data.</p> <p>IEEE-bus : SOUR:DM:CLOC:SOUR COUP</p> <p>EXT An external clock signal is fed externally. The clock synthesizer on the modulation coder is synchronized to this clock. Parameter SYMBOL RATE has to be correctly set with an accuracy of $\pm 1\%$.</p> <p>IEEE-bus : SOUR:DM:CLOC:SOUR EXT</p>
	MODE	<p>Selection of clock for the external clock signal</p> <p>SYMBOL An externally fed clock has to be a symbol clock.</p> <p>BIT An externally fed clock has to be a bit clock.</p> <p>IEC/IEEE-bus : SOUR:DM:CLOC:MODE SYMB</p>
	DELAY	<p>Input value of delay of generated modulation signal compared with an externally fed clock. This can be used, for example, for synchronization with a second unit to achieve time synchronicity between the modulation signals of the two units. The displayed setting resolution of 1/100 symbol is only attained for symbol-clock frequencies below 100 kHz. The actual resolution is reduced with increasing frequency. The delay can no longer be set for 7 Msymb/s</p> <p>IEC/IEEE-bus : SOUR:DM:CLOC:DEL 0.5</p>
POWER RAMP CONTROL...	Opens a window for setting the envelope control.	

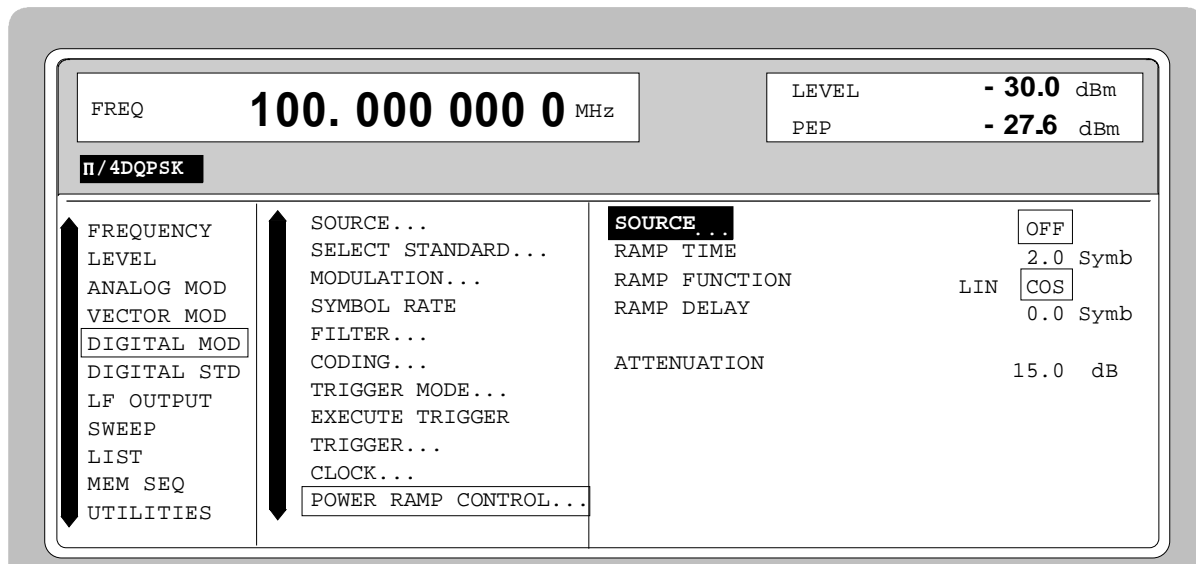

Fig. 2-67 DIGITAL MOD - POWER RAMP CONTROL menu, SMIQ equipped with option Modulation Coder SMIQB20 and option Data Generator SMIQB11

(POWER RAMP CONTROL...)

SOURCE

Selection between analog and digital envelope control and selection of source.

OFF Envelope control is switched off.

IEC/IEEE : SOUR:DM:PRAM:STAT OFF

INT Signals BGAT and LATT from the active CONTROL LIST (CLIST) are used for envelope control (only with option SMIQB11)

IEC/IEEE : SOUR:DM:PRAM:STAT ON
: SOUR:DM:PRAM:SOUR CLIST

EXT_ANALOG Envelope control is via an external analog signal that can be fed in via connector POWER RAMP.

IEC/IEEE-bus commands
: SOUR:DM:PRAM:STAT ON
: SOUR:DM:PRAM:SOUR AEXT

EXT_DIGITAL Envelope control is via external digital signals to be applied to BURST GATE and LEV ATT of connector PAR DATA.

IEC/IEEE-bus commands
: SOUR:DM:PRAM:STAT ON
: SOUR:DM:PRAM:SOUR DEXT

RAMP TIME

Input value of rise time of envelope after a transition from Low→High of signal BURST GATE and of fall time after a transition from High→Low.

The setting is a multiple of the symbol duration.

IEC/IEEE-bus : SOUR:DM:PRAM:TIME 3.0

(POWER RAMP CONTROL...)

RAMP FUNCTION

Determines the shape of the rising and falling edge during envelope control by means of the BURST GATE signal.

LIN Selection of a linear ramp function.

COS The edge is shaped according to a cosine function and a more favourable spectrum than that under setting LIN is obtained.

IEC/IEEE-bus : SOUR:DM:PRAM:SHAP COS

RAMP DELAY

Input value for a shift of the envelope characteristic to the modulated signal. A positive value causes a delay of the envelope. The values are set in the units of the symbol length.

IEC/IEEE-bus : SOUR:DM:PRAM:DEL 0.1

ATTENUATION

Input value of level reduction in dB with digital control signal LEV ATT used. This function is normally used - for TDMA frame structures - to generate a slot with reduced level.

IEC/IEEE-bus : SOUR:DM:PRAM:ATT 0 dB

EXT INPUTS

Opens a window for setting the trigger threshold, input impedance and polarity of the external digital modulation coder inputs, ie connector PAR DATA and inputs DATA, BIT CLOCK and SYMBOL CLOCK.

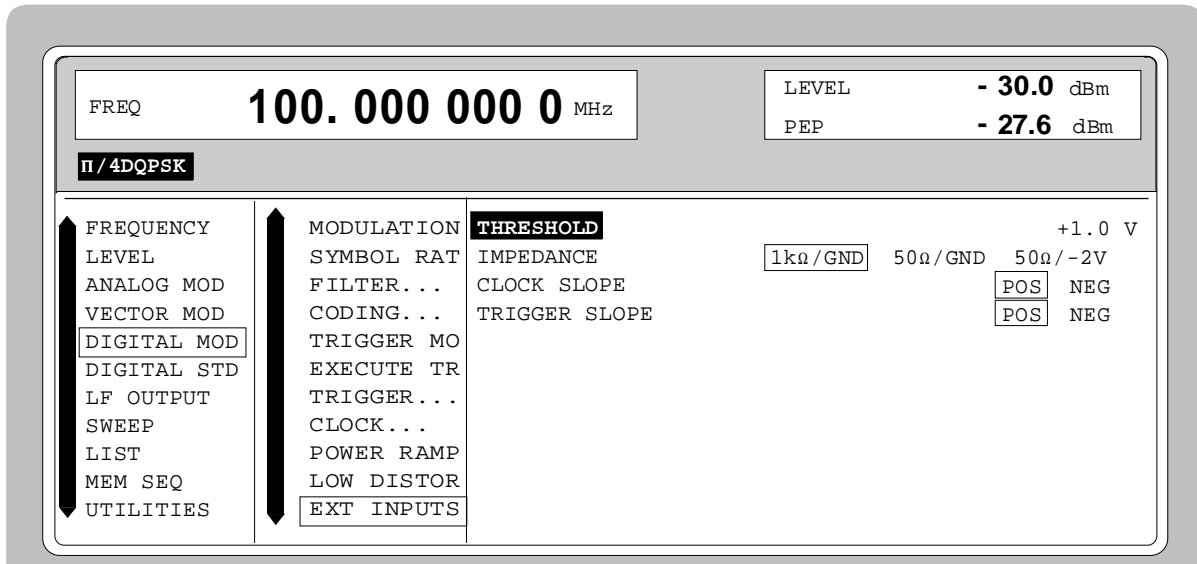

Fig. 2-68 DIGITAL MOD - EXT INPUTS menu, SMIQ equipped with option Modulation Coder SMIQB20 and option Data Generator SMIQB11

(EXT INPUTS...)

TRESHOLD

Input value of high/low threshold in Volt.

IEC/IEEE-bus command : SOUR:DM:THR 1.0

IMPEDANCE	<p>Selection of input impedance and reference voltage. 50 Ω/GND should be selected for higher clock rates. Setting 50 Ω/-2V is suitable for sources with ECL output. Make sure to select a suitable setting for the high/low threshold under TRESHOLD.</p> <p>IEC/IEEE-bus command : SOUR:DM:INP:IMP G1K</p>
CLOCK SLOPE	<p>Selection of polarity of active edge of externally fed bit clock or symbol clock.</p> <p>Note: <i>In the internal clock mode, CLOCK SLOPE NEG inverts the clock output signals.</i></p> <p>IEC/IEEE-bus : SOUR:DM:CLOC:POL NORM</p>
TRIGGER SLOPE	<p>Selection of polarity of active trigger edge for input TRIGIN.</p> <p>IEC/IEEE-bus : SOUR:DM:TRIG:SLOP POS</p>

2.11 Digital Standard PHS

With the options Modulation Coder (SMIQB20) and Data Generator (SMIQB11) provided, modulation signals according to the Japanese PHS standard¹ can be generated. PHS is a TDMA standard for private and public cordless phones.

SMIQ can generate both the transmit signal of a cell station (CS) and the transmit signal of a personal station (PS). Transmission from CS to PS is called "downlink", "uplink" being used for transmission in the opposite direction.

Uplink and downlink are transmitted in the separate time slots of a frame using the time duplex method. Each frame consists of 8 slots. The data contents of each slot can be defined individually by SMIQ by means of a slot editor. SMIQ can generate a control physical slot and also a communication physical slot. Each slot can be switched on or off. A defined intermediate level can also be set.

A burst type has to be defined to configure a slot. The following burst types can be selected:

- TCHFULL simulation of a communication channel for a speech coder rate of 32 kbit/s,
- TCHHALF simulation of a communication channel for a speech coder rate of 16 kbit/s,
- VOX simulation of a communication channel in non-speech intervals with uplink transmission only in every fourth frame,
- SYNC, simulation of a sync channel and
- ALL_DATA burst type for test purposes with freely programmable data contents in the selected slot.

The following internal modulation sources are available:

- different PRBS generators with a sequence length between 2^9-1 and $2^{23}-1$ and
- data lists, ie freely programmable data sequences from the data generator memory.

For generating the PHS signals, SMIQ inserts the modulation data continuously (in real time) into the selected slots. Using a digital signal processor the data generator generates a data sequence with modulation data and control signals for envelope control.

The data generator in SMIQ generates a data stream which is converted into IQ signals in the modulation coder. According to the PHS standard, the modulation type is $\pi/4$ DQPSK at a symbol rate of 192 ksymbol/s and $\sqrt{\text{COS}}$ filtering. Symbol rate and filtering can be changed in SMIQ.

¹ Personal Handy Phone System ARIB Standard (RCR STD-28)

2.11.1 Sync and Trigger Signals

The data generator generates a data sequence with modulation data, control signals for envelope control, and synchronization signals.

When TRIGGER MODE AUTO is selected, the PHS signal generation automatically starts.

This start can also be activated by an external trigger signal (TRIGGER MODE ARMED_AUTO) which allows a synchronous sequence for BER measurements to be carried out on receivers.

Trigger signals for synchronized sequences can be used for measuring the bit error rate of receivers. A trigger signal can be fed via the TRIGIN input at connector PAR DATA. The active slope of a trigger signal applied there executes a trigger event.

PHS signal generation at a frame limit is started after a trigger event. Data from data lists are inserted into the selected slots starting from the first bit. PRBS generators start with the set initialization status.

Signal generation either starts immediately after the active slope of the trigger signal or after a settable number of symbols (EXT TRIGGER DELAY). Retriggering (RETRIG) can be inhibited for a settable number of symbols (EXT RETRIGGER INHIBIT).

A trigger event can be executed manually or via the IEC/IEEE bus using EXECUTE TRIGGER.

When a trigger event is executed, a trigger signal is output at the TRIGOUT 3 output of SMIQ.

SMIQ also generates the following sync signals:

- a frame clock at TRIGOUT 1 output,
- a frame or multiframe clock at TRIGOUT 2 output with settable position in the frame,
- the symbol clock and the bit clock.

A clock synthesizer on the modulation coder generates the symbol clock and the bit clock in SMIQ. All the clock signals are synchronized to the 10-MHz reference of SMIQ. The symbol clock is available at connector SYMBOL CLOCK and the bit clock at connector BIT CLOCK. If required, the clock synthesizer in SMIQ can be synchronized to an external symbol or bit clock.

The clock signal is selected in the menu via CLOCK-CLOCK SOURCE EXT.

To allow for a trouble-free synchronization of the clock synthesizer first apply the external clock and set the correct symbol rate at SMIQ. Then switch CLOCK SOURCE from INT to EXT.

Notes: - *The set symbol rate should not differ by more than 1% from the symbol rate of the external signal.*

2.11.2 PN Generators as Internal Data Source

Independent PN generators (Pseudo Noise) can be selected for each slot as data source for data fields DATA and SACCH. These PN generators provide pseudo-random bit sequences of different length or period. That is why they are also called PRBS generators (Pseudo Random Binary Sequences). Data sequences are sequences of maximum length which are generated by means of feedback shift registers.

The following figure gives an example of a 9 bit generator with feedbacks after register 4 and 0 (output).

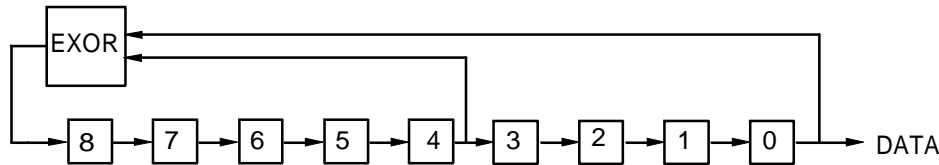

The pseudo-random sequence of a PRBS generator is clearly defined by the number of registers and the feedback. The following table describes all PRBS generators available:

Table 2-13 PRBS generators for PHS

PRBS generator	Length in bits	Feedback after
9 bit	$2^9 - 1 = 511$	Register 4, 0
11 bit	$2^{11} - 1 = 2047$	Register 2, 0
15 bit	$2^{15} - 1 = 32767$	Register 1, 0
16 bit	$2^{16} - 1 = 65535$	Register 5, 3, 2, 0
20 bit	$2^{20} - 1 = 1048575$	Register 3, 0
21 bit	$2^{21} - 1 = 2097151$	Register 2, 0
23 bit	$2^{23} - 1 = 8388607$	Register 5, 0

PN generators PN9,11,15,20 and PN23 are configured according to CCITT Rec. 0.151/152/153. The output sequence is inverted for generators PN15 and PN23.

The start value of the PN generators is different in the slots and equals

$$\text{start value} = 1 + 14 \text{ hex} \times \text{slot number}$$

Example: PN9 generator in slot 1 with start value 15hex = 10101 binary.

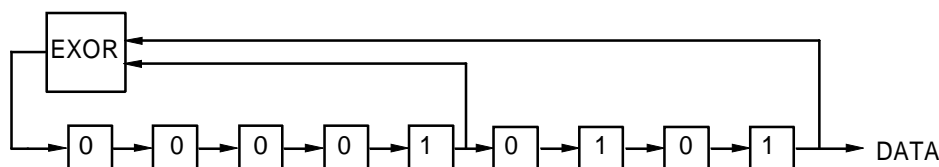

The resulting output sequence is 1010100000010100101011110010 etc.

2.11.3 Lists as Internal Data Source

A freely programmable memory on the data generator serves as internal data source for the data fields of the slots. The data are managed in so-called lists. A list editor allows to select, copy, modify and delete data lists (DATA LIST).

The list editor is available via menu DIGITAL-MOD - SOURCE....

2.11.4 External Modulation Data

External data can (only) be applied via the SERDATA interface. A selection of SERDATA as data source is only possible for a single data field of a slot. For further information on the characteristics of the SERDATA interface see Annex A.

To ensure that the external data bits are assigned to specific positions in the data field of the selected slot and that they are reproducible, the buffer of the RS-232 transmitter and receiver has to be deleted. A triggered start has to follow.

The following setting sequence is required in the DIGITAL STD - PHS menu:

1. Carry out desired settings in menu.
2. Select data source SERDATA for the data field of the slot using SELECT SLOT -
3. Make connection to external data source, but do not yet start external data source.
4. Switch off digital standard using STATE - OFF.
5. Set TRIGGER MODE ARMED_AUTO.
In this state, SMIQ is ready for reception, but discards data that are read in via SERDATA.
6. Switch on digital standard with STATE ON.
7. Start external data source.
The read-in data are written into the receiving buffer. Only if this buffer is filled can SMIQ react to a trigger event.
8. Activate trigger event. Signal generation is thus started at a frame limit. The first bit received via SERDATA is put to the first bit position in the selected data field.

2.11.5 Menu DIGITAL STANDARD - PHS

Menu DIGITAL STD - PHS provides access to settings for generating PHS signals.

Menu selection: DIGITAL STD - PHS

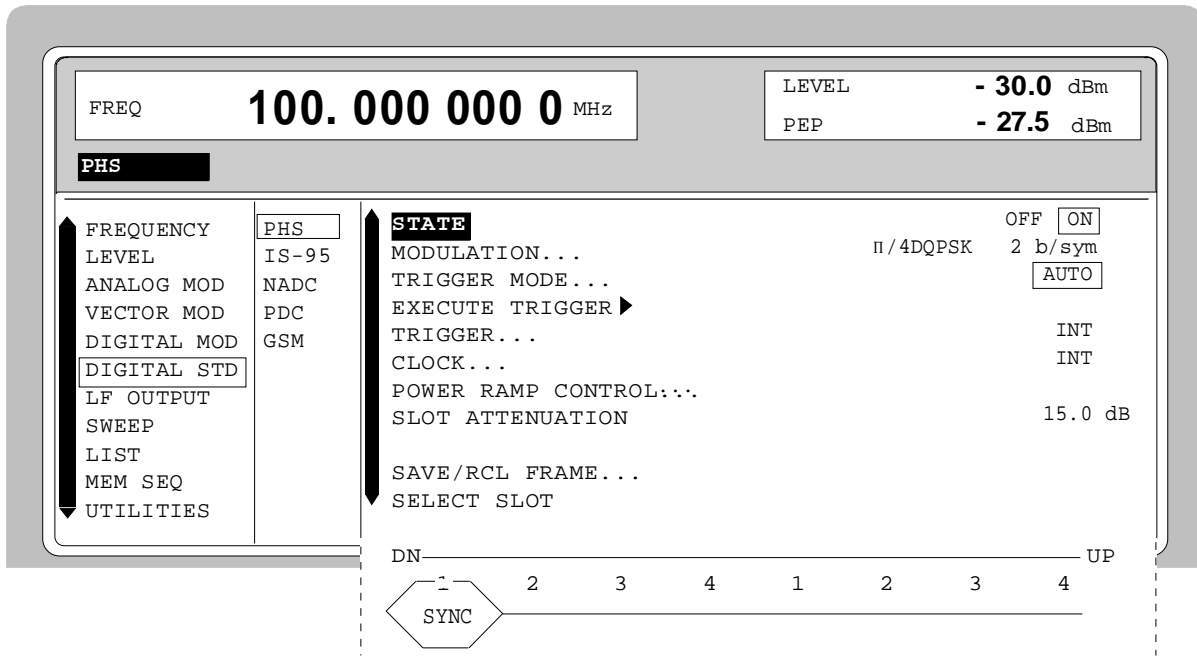

Fig. 2-69 Menu DIGITAL STD - PHS, SMIQ equipped with Modulation Coder SMIQB20 and Data Generator SMIQB11

STATE Switch on/off of Digital Standard PHS modulation. Vector Modulation or Digital Modulation will be switched off automatically.

IEC/IEEE-bus command : SOUR:PHS:STAT ON

MODULATION... Opens a window for setting the modulation parameters.

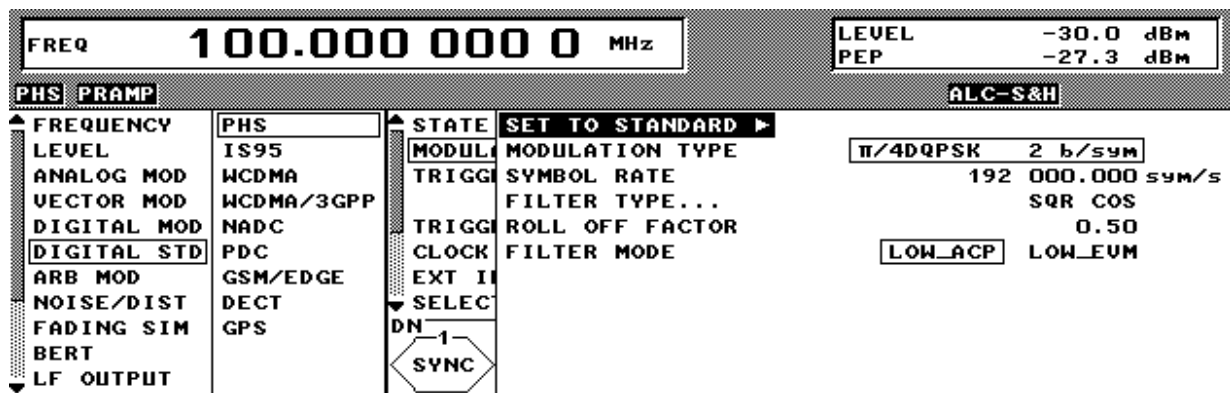

Fig. 2-70 Menu DIGITAL STD - PHS - MODULATION..., SMIQ equipped with Modulation Coder SMIQB20 and Data Generator SMIQB11

(MODULATION...)	SET TO STANDARD ►	Sets the subsequent modulation parameters to the values predefined by the standard.
	MODULATION TYPE	Displays the modulation type.
	SYMBOL RATE	Input value for the symbol rate. 192 ksymbol/s are preset. IEC/IEEE-bus : SOUR:PHS:SRAT 192.01 KHZ
	FILTER	Selection of baseband filter. A selection between Nyquist filters COS, SQRCOS and a user-defined filter USER (cf. Section Digital Modulation) is possible. IEC/IEEE-bus : SOUR:PHS:FILT:TYPE COS
	ROLL OFF FACTOR	Input value for the roll-off factor. IEC/IEEE-bus SOUR:PHS:FILT:PAR 0.50
	FILTER MODE	Selection of filter mode. LOW_ACP Filter for minimum <u>A</u> djacent <u>C</u> hannel <u>P</u> ower. IEC : SOUR:PHS:FILT:MODE LACP LOW_EVM Filter for minimum vector error. IEC : SOUR:PHS:FILT:MODE LEVM
TRIGGER MODE...		Opens a window for selecting the trigger mode.
	AUTO	The PHS signals are continuously transmitted in the activated slots. IEC/IEEE-bus command : SOUR:PHS:SEQ AUTO
	RETRIG	The PHS signals are continuously transmitted in the activated slots. A trigger event causes a restart. IEC/IEEE-bus command : SOUR:PHS:SEQ RETR
	ARMED_AUTO	The PHS signal generation does not start until a trigger event has occurred. The unit then automatically switches over to the AUTO mode and can no longer be triggered. IEC/IEEE-bus command : SOUR:PHS:SEQ AAUT
	ARMED_RETRIG	The PHS signal generation does not start until a trigger event has occurred. The unit then automatically switches over to the RETRIG mode. Each new trigger event causes a restart. IEC/IEEE-bus command : SOUR:PHS:SEQ ARET
EXECUTE TRIGGER ►		Executes a trigger even to start the PHS signal generation. IEC/IEEE-bus command : TRIG:DM:IMM
TRIGGER...		Opens a window for selecting the trigger source, for configuring the trigger output signals and for setting the time delay of an external trigger signal.

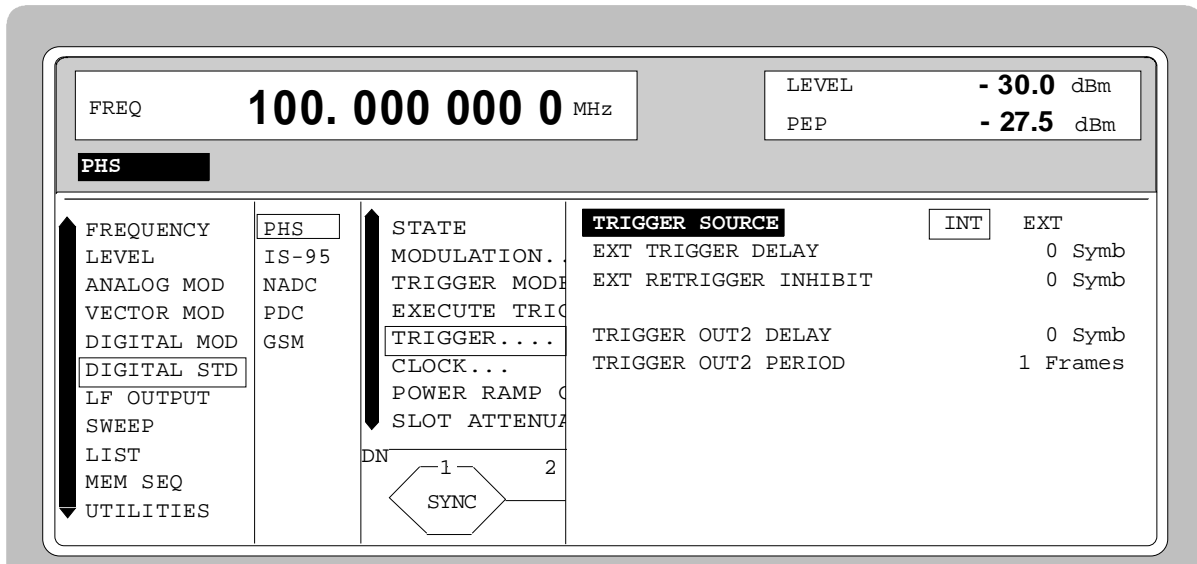

Fig. 2-71 Menu DIGITAL STD - PHS_TRIGGER..., SMIQ equipped with Modulation Coder SMIQB20 and Data Generator SMIQB11

(TRIGGER...)	TRIGGER SOURCE	Selection of trigger source.
		EXT The PHS signal generation is started by the active slope of an external trigger signal. The polarity, the trigger threshold and the input resistance of the TRIGIN input can be modified in menu DIGITAL MOD - EXT INPUTS.
		INT A trigger event can be executed by EXECUTE TRIGGER ►.
		IEC/IEEE-bus : SOUR:PHS:TRIG:SOUR EXT

(TRIGGER...)	EXT TRIGGER DELAY	<p>Setting the number of symbols by which an external trigger signal is delayed before it starts the PHS signal generation.</p> <p>This is used for setting the time synchronization between the the SMIQ and the DUT.</p> <p>IEC/IEEE-bus command : SOUR:PHS:TRIG:DEL 3</p>
	EXT RETRIGGER INHIBIT	<p>Setting the number of symbols for which a restart is inhibited after a trigger event.</p> <p>With TRIGGER MODE RETRIG selected, each new trigger signal restarts the PHS signal generation. This restart can be inhibited for the entered number of symbols.</p> <p>Example: The entry of 1000 symbols causes new trigger signals to be ignored for the duration of 1000 symbols after a trigger event</p> <p>IEC/IEEE-bus : SOUR:PHS:TRIG:INH 1000</p>
	TRIGGER OUT 2 DELAY	<p>Input value of delay of trigger signal at TRIGOUT 2 output compared with beginning of frame.</p> <p>IEC/IEEE-bus : SOUR:PHS:TRIG:OUTP:DEL 2</p>
	TRIGGER OUT2 PERIOD	<p>Input value of output signal period at TRIGOUT 2 output given in frames.</p> <p>IEC/IEEE-bus : SOUR:PHS:TRIG:OUTP:PER 1</p>

CLOCK... Opens a window for selecting the clock source and for setting a delay.

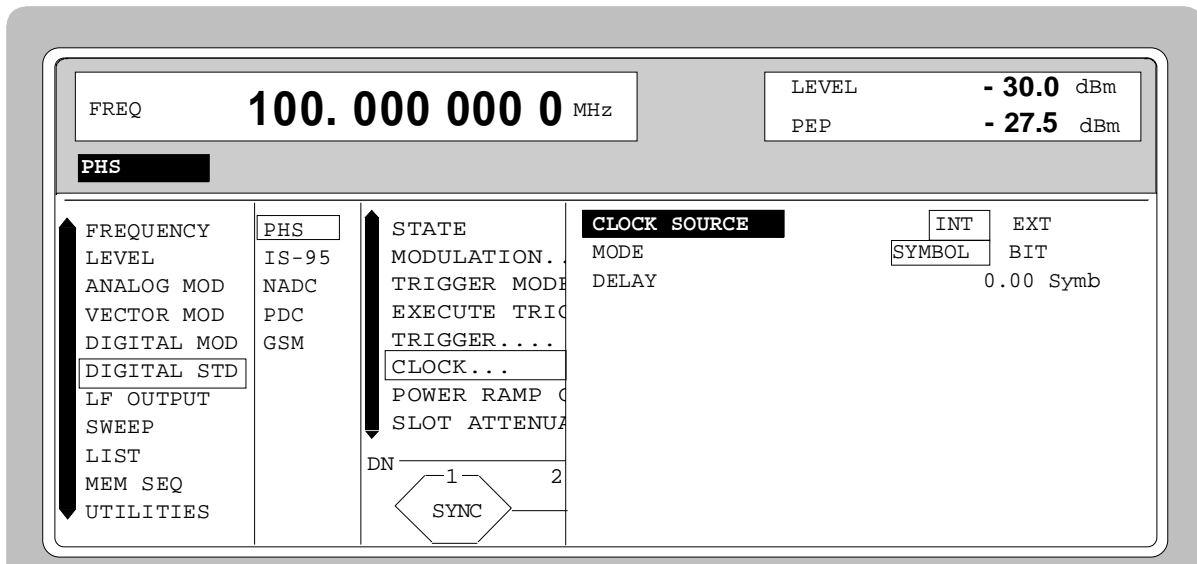

Fig. 2-72 Menu DIGITAL STD - PHS - CLOCK..., SMIQ equipped with Modulation Coder SMIQB20 and Data Generator SMIQB11

(CLOCK...)	CLOCK SOURCE	<p>Selection of clock source.</p> <p>INT SMIQ uses internally generated clock signals.</p> <p>EXT An external symbol clock or bit clock is fed in at connectors SYMBOL CLOCK or BIT CLOCK. The clock synthesizer on the modulation coder is synchronized to this clock. The symbol rate has to be set with an accuracy of $\pm 1\%$. The polarity, the trigger threshold and the input resistance of the clock inputs can be modified in menu DIGITAL MOD - EXT INPUTS.</p> <p>IEC/IEEE-bus command : SOUR:PHS:CLOC:SOUR INT</p>
	MODE	<p>Selection of clock for external clock signal.</p> <p>SYMBOL The external clock has to be a symbol clock.</p> <p>BIT The external clock has to be a bit clock.</p> <p>IEC/IEEE-bus command : SOUR:PHS:CLOC:MODE SYMB</p>
	DELAY	<p>Setting the delay of generated modulation signal to an external clock.</p> <p>This can be used, for example, for synchronization with a second unit to achieve time synchronization between the modulation signals of the two units.</p> <p>IEC/IEEE-bus command : SOUR:PHS:CLOC:DEL 0.5</p>

POWER RAMP CONTROL...

Opens a window for setting the envelope control, especially for the rising and falling ramp at the beginning and end of a slot.

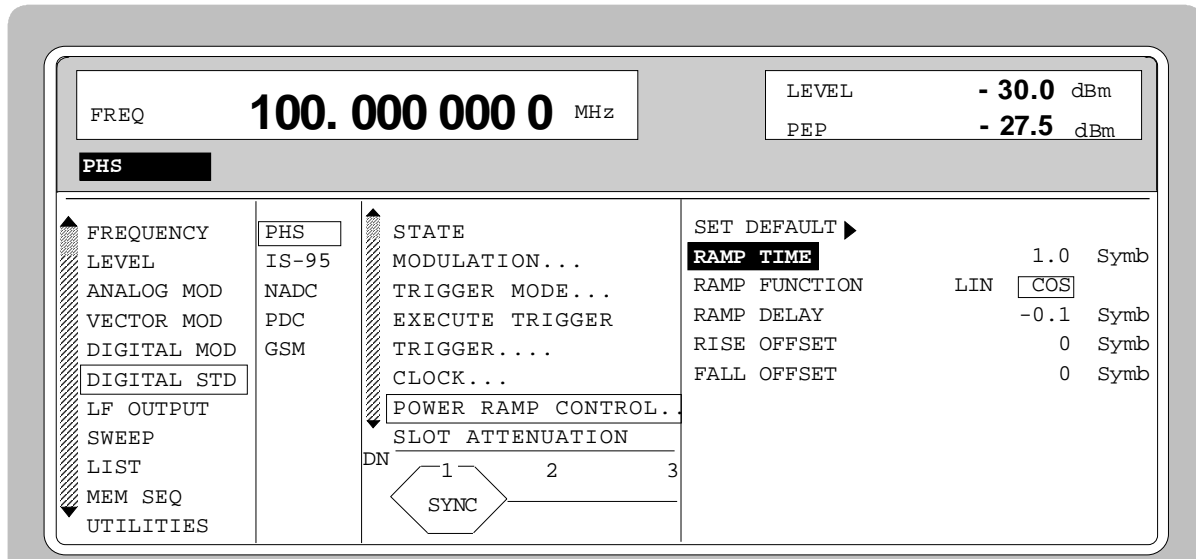

Fig. 2-73 Menu DIGITAL STD - PHS - POWER RAMP CONTROL... , SMIQ equipped with Modulation Coder SMIQB20 and Data Generator SMIQB11

(POWER RAMP CONTROL...)

SET DEFAULT ►

Resets the subsequent parameters to the factory-set values.

IEC/IEEE-bus : SOUR : PHS : PRAM : PRES

RAMP TIME

Input value for the rise and fall time of the envelope at the beginning or end of a slot. The time is set in units of symbol period.

IEC/IEEE-bus : SOUR : PHS : PRAM : TIME 0.25

RAMP FUNCTION

Selection of shape of rising and falling ramp for envelope control.

LIN Linear ramp function.

COS Cosine function. A more favourable spectrum than that of the LIN function is obtained.

IEC/IEEE-bus : SOUR : PHS : PRAM : SHAP LIN

RAMP DELAY

Input value for a shift of the envelope characteristic to the modulated signal. A positive value causes a delay of the envelope. The values are set in the units of the symbol length.

IEC/IEEE-bus : SOUR : PHS : PRAM : DEL 0.1

RISE OFFSET

Input value for a positive or negative offset of the rising ramp of the envelope at the beginning of a slot.

IEC/IEEE-bus : SOUR : PHS : PRAM : ROFF -1

FALL OFFSET

Input value for a positive or negative offset of the falling ramp of the envelope at the end of a slot.

IEC/IEEE-bus : SOUR : PHS : PRAM : FOFF 1

SLOT ATTENUATION Input value for the level reduction in dB of all active slots whose SLOT LEVEL was set to ATTN. Menu SELECT SLOT allows the slots to be determined whose level is to be reduced.

IEC/IEEE-bus command : SOUR:PHS:SLOT:ATT 40 DB

SAVE/RCL FRAME... Opens a window for saving and loading a frame configuration. Loading a frame affects all parameters that can be set under SELECT SLOT.

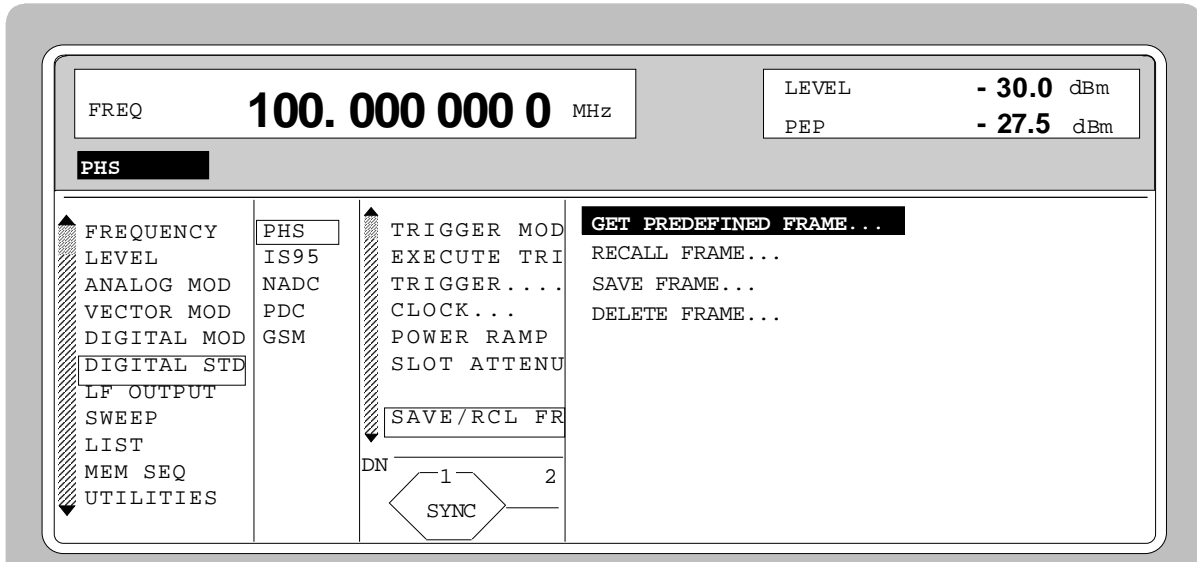

Fig. 2-74 Menu DIGITAL STD - PHS - SAVE/RCL FRAME, SMIQ equipped with Modulation Coder SMIQB20 and Data Generator SMIQB11

(SAVE/RCL FRAME...)	GET PREDEFINED FRAME...	<p>Loads a factory-set frame configuration.</p> <p>DN1_TCH Downlink Traffic Channel in slot1</p> <p>UP1_TCH Uplink Traffic Channel in slot1</p> <p>DN1_SYNC Downlink Sync Channel in slot1</p> <p>IEEE : SOUR:PHS:FLIS:PRED:LOAD "DN1_TCH"</p>
	RECALL FRAME...	<p>Loads a frame configuration saved by the user.</p> <p>IEC/IEEE-bus : SOUR:PHS:FLIS:LOAD "name"</p>
	SAVE FRAME...	<p>Saves a user-defined frame configuration.</p> <p>IEC/IEEE-bus : SOUR:PHS:FLIS:STOR "name"</p>
	DELETE FRAME...	<p>Deletes a frame configuration saved by the user.</p> <p>IEC/IEEE-bus : SOUR:PHS:FLIS:DEL "name"</p>

SELECT SLOT...

Selection of one of 8 possible slots. When selecting the slot, a window is opened in which the data contents belonging to this slot can be defined. 4 slots are available for uplink and downlink. They are designated as UP<i> and DN<i> in the display. For remote control, the slots are numbered from 1 to 8. The following assignment applies:

Slot	DN1	DN2	DN3	DN4	UP1	UP2	UP3	UP4
Slot number	1	2	3	4	5	6	7	8

If the cursor is placed onto a slot in the diagram, it may be switched on and off by pressing one of the unit keys (toggle function).

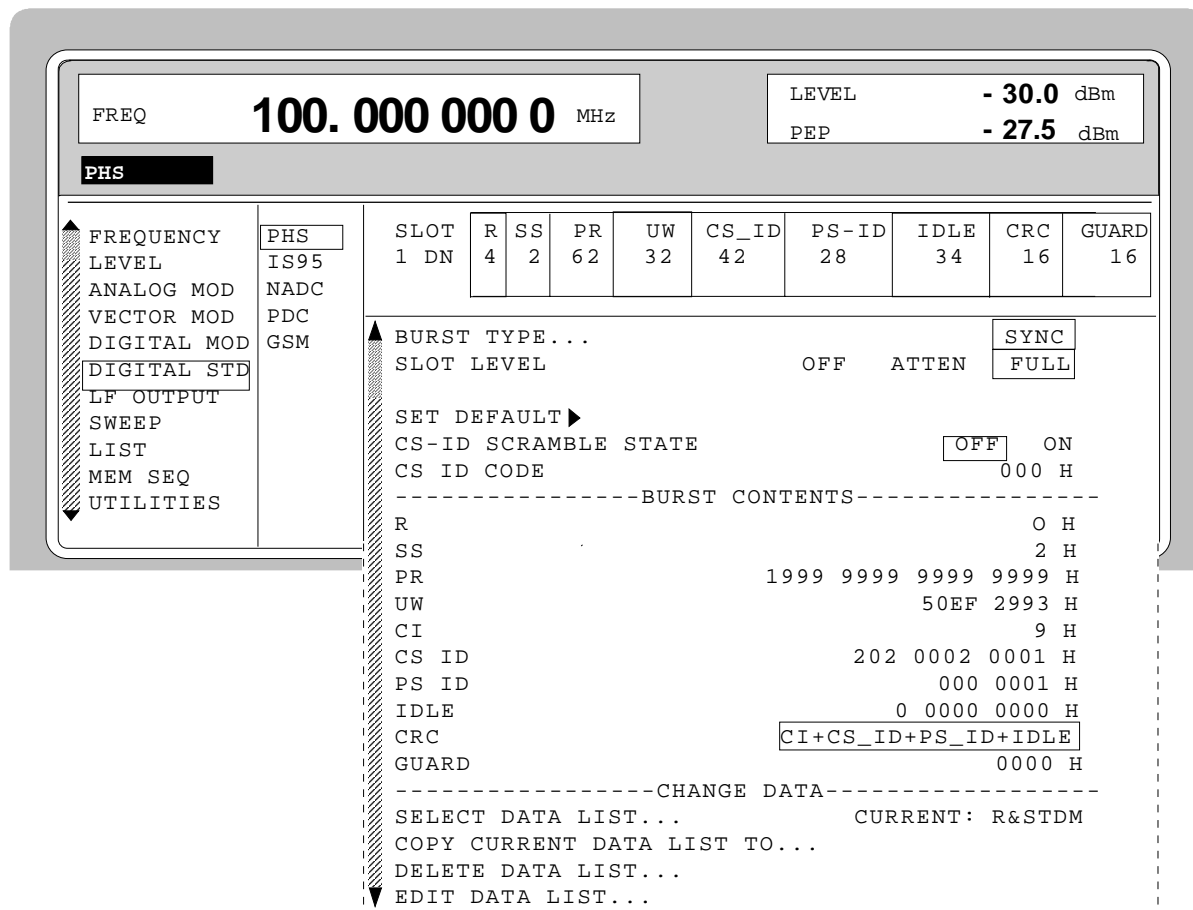

Fig. 2-75 Menu DIGITAL STD - PHS - SELECT SLOT, SMIQ equipped with Modulation Coder SMIQB20 and Data Generator SMIQB11

(SELECT SLOT)	BURST TYPE...	<p>Opens a window for the selection of the burst type used to configure the selected slot.</p> <p>TCH_FULL Traffic channel configuration (rate 32 kbit/s) IEEE-bus : SOUR:PHS:SLOT2:TYPE TCHF</p> <p>TCH_HALF Traffic channel configuration (rate 16 kbit/s) IEEE-bus : SOUR:PHS:SLOT2:TYPE TCHH</p> <p>VOX VOX configuration. In slots 4 to 8 (uplink) transmission is only in every fourth frame. IEEE-bus : SOUR:PHS:SLOT2:TYPE VOX</p> <p>SYNC Sync burst IEEE-bus : SOUR:PHS:SLOT2:TYPE SYNC</p> <p>ALL DATA Burst type for testing with freely programmable data contents IEEE-bus SOUR:PHS:SLOT2:TYPE ADAT</p>
	SLOT LEVEL	<p>Selection of level for selected slot.</p> <p>OFF Maximum attenuation IEEE bus : SOUR:PHS:SLOT2:LEV OFF</p> <p>FULL The level corresponds to the value indicated on the SMIQ LEVEL display. IEEE bus : SOUR:PHS:SLOT2:LEV FULL</p> <p>ATTEN The level is reduced by the value set under SLOT ATTENUATION. IEEE bus : SOUR:PHS:SLOT2:LEV ATT</p>
	SET DEFAULT ►	<p>Resets the subsequent parameters to the factory-set values. IEC/IEEE-bus command : SOUR:PHS:SLOT8:PRES</p>
	CS-ID SCRAMBLE STATE	<p>Switch on/off of CS-ID scrambling function. IEC/IEEE-bus : SOUR:PHS:SLOT2:SCR:STAT ON</p>
	CS-ID CODE	<p>Input value in hexadecimal form for initializing the scramble generator. IEEE-bus : SOUR:PHS:SLOT2:SCR:CODE #H123</p>
	ENCRYPTION STATE	<p>Switch on/off of encryption scrambling function. This parameter is only available for TCH burst types. IEC/IEEE-bus : SOUR:PHS:SLOT2:ENCR:STAT ON</p>
	SECURITY KEY	<p>Input value in hexadecimal form for initializing the scramble generator. This parameter is only available for TCHburst types. IEEE-bus : SOUR:PHS:SLOT2:ENCR:KEY #H1234</p>

(SELECT SLOT)	R	Display of data contents in the 4-bit data field "Ramp".
	SS	Display of data contents in the 2-bit data field "Start Symbol".
	PR	Display of "Preamble".
	UW	Input value for the "Unique Word" in hexadecimal form. The length of the hexadecimal value depends on the slot type (16 32 bit). IEC/IEEE-bus : SOUR:PHS:SLOT2:UWOR #H3D4C
	CI	Display of the "Channel Identifier" data field in hexadecimal form.
	SA	Selection of data source for SACCH. This data field is only displayed for burst types TCH and VOX. PN.. PRBS data according to CCITT V52 or Rec. 0.151 with periods between 2^9-1 and $2^{23}-1$. IEEE : SOUR:PHS:SLOT3:SACCH PN9 DLIST Data from a programmable data list. IEEE : SOUR:PHS:SLOT3:SACCH DLIS SERDATA Data from data input SER DATA IEEE : SOUR:PHS:SLOT3:SACCH SDAT
	TCH / VOX	Selection of data source for TCH data field. This data field is only displayed for burst types TCH and VOX. PN.. PRBS data according to CCITT V52 or Rec. 0.151 with periods between 2^9-1 and $2^{23}-1$. IEEE : SOUR:PHS:SLOT3:TCH PN9 DLIST Data from a programmable data list. IEEE : SOUR:PHS:SLOT3:TCH DLIS SERDATA Data from data input SER DATA IEEE : SOUR:PHS:SLOT3:TCH SDAT
	CS-ID	Input value for the "Cell Station ID Code" field in hexadecimal form. This data field is only displayed for the burst type SYNC. IEEE-bus : SOUR:PHS:SLOT2:CSID #H20200020001

(SELECT SLOT)	PS-ID	<p>Input value for the "Personal Station ID Code" field in hexadecimal form. This data field is only displayed for the burst type SYNC.</p> <p>IEEE-bus : SOUR:PHS:SLOT2:PSID #H0000001</p>
	IDLE	<p>Display of data contents in the "Idle" field. This field is only displayed for the burst type SYNC.</p>
	CRC	<p>Indication of data fields for calculating the CRC code.</p>
	GUARD	<p>Display of data contents in the "Guard" field in hexadecimal form.</p>
	SELECT DATA LIST...	<p>Opens a window for selecting a stored data list or for generating a new list.</p>
	COPY CURRENT DATA LIST TO...	<p>Stores the current data list under a different name.</p>
	DELETE DATA LIST...	<p>Deletes a data list.</p>
	EDIT DATA LIST...	<p>Opens a window for editing a data list bit-by-bit. The available storage capacity and the length of the current list is displayed in parameters FREE and LEN (see also Section List Editor).</p> <p>COPY Copies a list range</p> <p>FILL Fills the range with filler pattern</p> <p>INSERT Inserts a list range at a different position of the list</p> <p>DELETE Deletes a list range</p> <p>EDIT/VIEW Edits or views the list</p>

2.12 Digital Standard IS-95 CDMA

With the options Modulation Coder (SMIQB20), Data Generator (SMIQB11) and option Digital Standard CDMA (SMIQB42) provided, CDMA signals can be generated according to standard IS-95¹ as well as J-STD-008.

SMIQ can simulate both the transmit signal of a base station (forward link) and the transmit signal of a mobile station (reverse link). The forward link signal consists of up to 64 code channels. A reverse link signal can be generated in the full-rate or half-rate mode.

Simple bit patterns or pseudo random bit sequences (PRBS) can be selected as modulation data for forward link. Every code channel has a different PRBS. Modulation data are not subject to channel coding (convolution coding, interleaving).

The following figure shows the schematic of forward link signal generation.

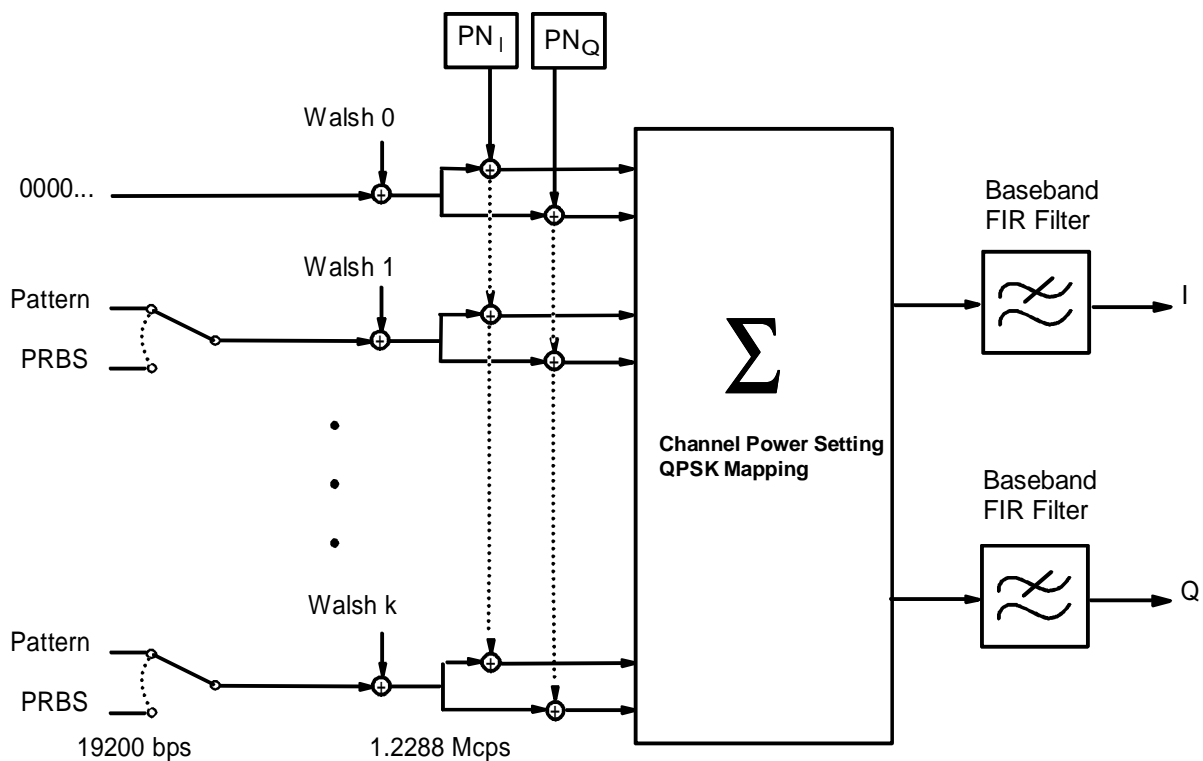

Fig. 2-76 Forward link signal generation

At a chip rate of 1.2288 Mcps, the modulation data rate for forward link is 19200 bp/s for all channels. The modulation type is QPSK. For baseband filtering, a FIR filter with equalizer is preset according to IS-95 (FILTER TYPE IS-95 EQUAL). Other filters can be set as well. The chip rate is preset to 1.2288 Mcps according to IS-95 but can be freely selected.

¹ TIA/EIA/IS-95, Mobile Station-Base Station Compatibility Standard for Dual-Mode Wideband Spread Spectrum Cellular Systems

To generate a reverse link signal, two different operating modes are available. The following figure shows the schematic of reverse link signal generation without channel coding.

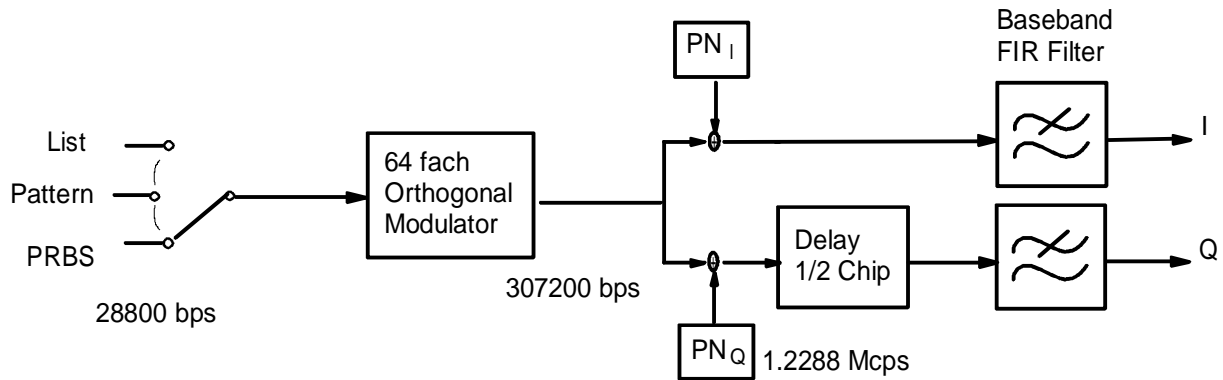

Fig. 2-77 Reverse link signal generation without channel coding

Simple bit patterns, PRBS and freely programmable data sequences in a data list are available as modulation data. At a chip rate of 1.2288 MHz, the modulation data rate of the reverse link is 28800 bps/s. The modulation type is offset-QPSK. A FIR filter is preset as baseband filter without equalizer according to IS-95 (FILTER TYPE IS-95).

The second reverse link mode also comprises channel coding. With this reverse link coded mode, both an access channel (4800 bps) and a traffic channel can be generated with all the data rates between 1200 bps and max. 14400 bps complying with IS-95 (Rate Set 1 and 2). The following figure gives an example of signal generation for the traffic channel with 9600 bps and shows the associated frame structure.

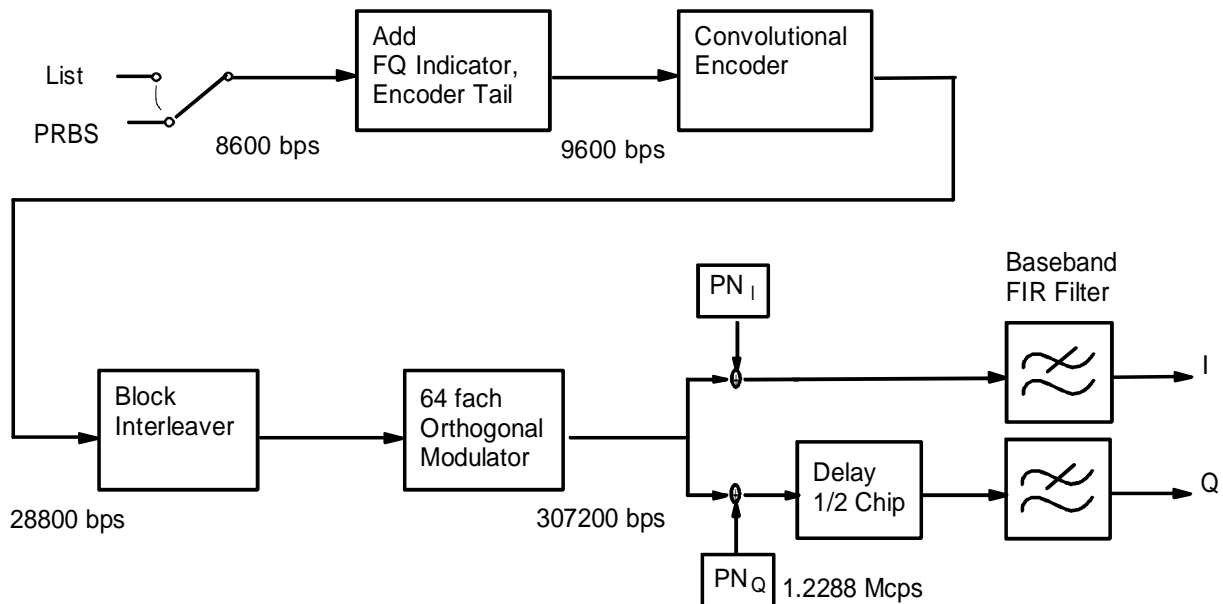

Fig. 2-78 Traffic channel 9600 in "Reverse Link Coded" mode

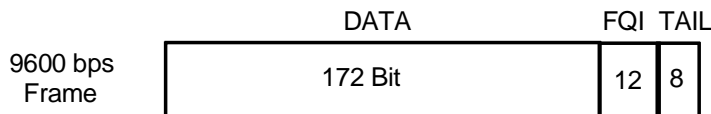

Fig. 2-79 Frame structure of traffic channel 9600 in "Reverse Link Coded" mode

PRBS of different lengths and a list of freely programmable data sequences are available as modulation data. In the reverse link coded mode, SMIQ generates a test signal for BER and FER measurements at a base station receiver. A special service mode is required for the DUT since the long code is set to 0 in the SMIQ test signal.

To facilitate operation, the following tables show the frequency channels according to regulations IS-95 and J-STD-008. The tables are also available on the SMIQ display via the HELP function for IS-95 menu selection.

Table 2-14 CDMA: channel numbers and their frequencies

IS-95	channel number	generator frequency /MHz
Mobile station	$1 \leq N \leq 777$ $1013 \leq N \leq 1023$	$0.03N + 825.0$ $0.03(N-1023)+825.0$
Base station	$1 \leq N \leq 777$ $1013 \leq N \leq 1023$	$0.03N + 870.0$ $0.03(N-1023)+870.0$

J-STD-008	channel number	generator frequency/MHz
Mobile station	$1 \leq N \leq 1199$	$0.050N + 1850.000$
Base station	$1 \leq N \leq 1199$	$0.050N + 1930.000$

Table 2-15 Preferred CDMA-frequency channels according to J-STD-008

channel number	generator-frequency/MHz		channel number	generator-frequency/MHz	
	mobile station	base station		mobile station	base station
25	1851.25	1931.25	600	1880.00	1960.00
50	1852.50	1932.50	625	1881.25	1961.25
75	1853.75	1933.75	650	1882.50	1962.50
100	1855.00	1935.00	675	1883.75	1963.75
125	1856.25	1936.25	725	1886.25	1966.25
150	1857.50	1937.50	750	1887.50	1967.50
175	1858.75	1938.75	775	1888.75	1968.75
200	1860.00	1940.00	825	1891.25	1971.25
225	1861.25	1941.25	850	1892.50	1972.50
250	1862.50	1942.50	875	1893.75	1973.75
275	1863.75	1943.75	925	1896.25	1976.25
325	1866.25	1946.25	950	1897.50	1977.50
350	1867.50	1947.50	975	1898.75	1978.75
375	1868.75	1948.75	1000	1900.00	1980.00
425	1871.25	1951.25	1025	1901.25	1981.25
450	1872.50	1952.50	1050	1902.50	1982.50
475	1873.75	1953.75	1075	1903.75	1983.75
500	1875.00	1955.00	1100	1905.00	1985.00
525	1876.25	1956.25	1125	1906.25	1986.25
550	1877.50	1957.50	1150	1907.50	1987.50
575	1878.75	1958.75	1175	1908.75	1988.75

2.12.1 Sync and Trigger Signals

A CDMA sequence with a length of 98304 chips is calculated for the generation of forward link CDMA signals and stored in the memory of the data generator (option SMIQB11). This chip sequence can be run repetitively (TRIGGER MODE AUTO). During reverse link signal generation with channel coding, the modulation data are continuously processed in real time.

Trigger signals can be used for synchronized measurements on receivers.

A trigger signal can be fed via the TRIGIN input at connector PAR DATA. The chip sequence either starts immediately after the active slope of the trigger signal or after a settable number of chips (TRIGGER DELAY). Retriggering (RETRIG) can be inhibited for a settable number of chips (TRIGGER INHIBIT).

A trigger event can be executed manually or via the IEC/IEEE bus using EXECUTE TRIGGER. When a trigger event is executed, a trigger signal is output at the TRIGOUT 3 output of SMIQ.

SMIQ also generates the following sync signals:

- a 20-ms frame clock (traffic channel frame clock)
- a 80/3-ms clock (short sequence rollover)
- a 80-ms clock (super frame clock)
- a 2-s clock (even second clock)
- a PCG clock in reverse link at half rate, 1/4 rate and 1/8 rate

SMIQ can output two of the four signals via pins TRIGOUT 1 and 2 of connector PAR DATA.

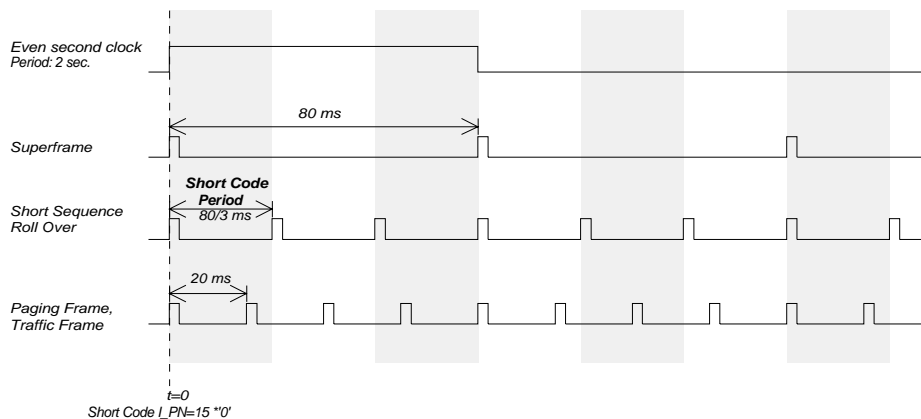

Fig. 2-80 CDMA sync signals

A clock synthesizer on the modulation coder generates the chip clock and a multifold chip clock in the SMIQ. All the clock signals are synchronized to the 10-MHz reference of the SMIQ. The chip clock is available at connector SYMBOL CLOCK and the multifold chip clock at connector BIT CLOCK. If required, the clock synthesizer in the SMIQ can be synchronized to an external chip clock which is fed in at connector SYMBOL CLOCK.

The clock signal is selected in the menu via CLOCK-CLOCK SOURCE EXT.

To allow for a trouble-free synchronization of the clock synthesizer first apply the external clock and set the correct symbol rate at SMIQ. Then switch CLOCK SOURCE from INT to EXT.

Note: *The set symbol rate should not differ by more than 1% from the symbol rate of the external signal.*

2.12.2 PRBS Data Source in Forward Link

A PN generator is used as PRBS data source for forward link modes. This PN generator provides a pseudo random bit sequence with a period of $2^{17}-1$. The PRBS data sequence is a so-called sequence of maximum length that is generated by means of a feedback shift register. The following schematic shows the PN generator with feedback to registers 3 and 0 (output). The data of the start value are entered into the register.

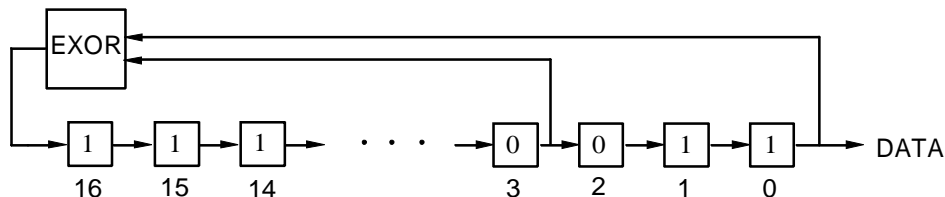

The start value of the PN generator is 1100 0100 1110 0011 1
 The bit sequence after the start thus is:

```

        1100 0100 1110 0011 1111 0001 1111 1110...
    ... 0011 1111 0000 0111 1110 0011 1001 1100...
    ... 0111 1111 1011 1111 1100 0001 0010 0000...
    ... 1110 0100 0001 0011 1110 0010 0100 0110.....
    
```

The generated bits are assigned to the modulation data of the different forward link modes as follows:

Mode FWD_LINK_18

The PN bits are assigned to the different code channels as follows:

Modulation data bit 0:

```

    1100 0100 1110 0011 1111 0001 1111 1110 ...
    ↑                               ↑
    c31, ch30, .....ch0 ...
    
```

Modulation data bit 1:

```

    0011 1111 0000 0111 1110 0011 1001 1100 ...
    ↑                               ↑
    ch31, ch30, .....ch0 ...
    
```

etc.

The data bits of the unused code channels c18 to c31 and those of the deactivated code channels are discarded, ie not used.

Modus FWD_LINK_64

The PN bits are assigned to the different code channels as follows:

Modulation data bit 0:

```

    11000100111000111111000111111110 00111111000001111110001110011100 ...
    ↑                               ↑ ↑                               ↑
    c31, ch30, .....ch0, ch63, ch62, .....ch32 ...
    
```

Modulation data bit 1:

```

    01111111101111111100000100100000.11100100000100111110001001000110 ...
    ↑                               ↑ ↑                               ↑
    c31, ch30, .....ch0, ch63, ch62, .....ch32 ...
    
```

etc.

The data bits of the deactivated code channels are discarded, ie not used.

2.12.3 PN Generators as Internal Data Source for Reverse Link

Different PN (Pseudo Noise) generators can be selected as data source for modulation data in the two reverse link modes. These PN generators provide pseudo random bit sequences of different lengths or periods which is why they are also called PRBS generators (Pseudo Random Binary Sequence). The data sequences are so-called sequences of maximum lengths that are generated by means of feedback shift registers.

The following schematic shows the 9 bit generator with feedback to registers 4 and 0 (output).

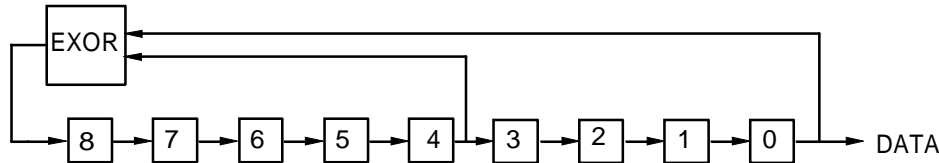

The pseudo random sequence of a PRBS generator is determined by the number of registers and the feedback. The following table describes all available PRBS generators:

Table 2-16 PN generators for IS-95 reverse link

PRBS generator	Length in bits	Feedback to	Start value
9 bits	$2^9 - 1 = 511$	Register 4, 0	1100 0100 1
11 bits	$2^{11} - 1 = 2047$	Register 2, 0	1100 0100 111
15 bits	$2^{15} - 1 = 32767$	Register 1, 0	1100 0100 1110 001
16 bits	$2^{16} - 1 = 65535$	Register 5, 3, 2, 0	1100 0100 1110 0011
20 bits	$2^{20} - 1 = 1048575$	Register 3, 0	1100 0100 1110 0011 1111
21 bits	$2^{21} - 1 = 2097151$	Register 2, 0	1100 0100 1110 0011 1111 0
23 bits	$2^{23} - 1 = 8388607$	Register 5, 0	1100 0100 1110 0011 1111 000

PN generators PN9,11,15,20 and PN23 are designed according to CCITT Rec. 0.151/152/153. The output sequence is inverted for generators PN15 and PN23.

Example: PN9 generator in slot 1 with start value 110001001 (binary)

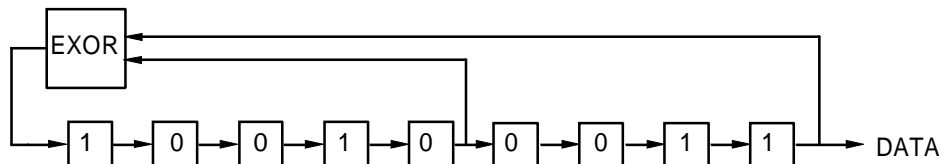

The resulting output sequence is 110001001100010001000 etc.

2.12.4 Menu IS-95 CDMA Standard - Forward Link Signal

Menu DIGITAL STD - IS-95 provides access to settings for IS-95 CDMA signal generation. The following figure shows the menu for generating the forward link signal (transmit signal of base station) in the FWD_LINK_18 mode. The menus for generating reverse link signals are described in the following section. Parameters that are identical for both modes are explained in the menu for forward link.

Menu selection: DIGITAL STD - IS-95- MODE - FWD_LINK_18

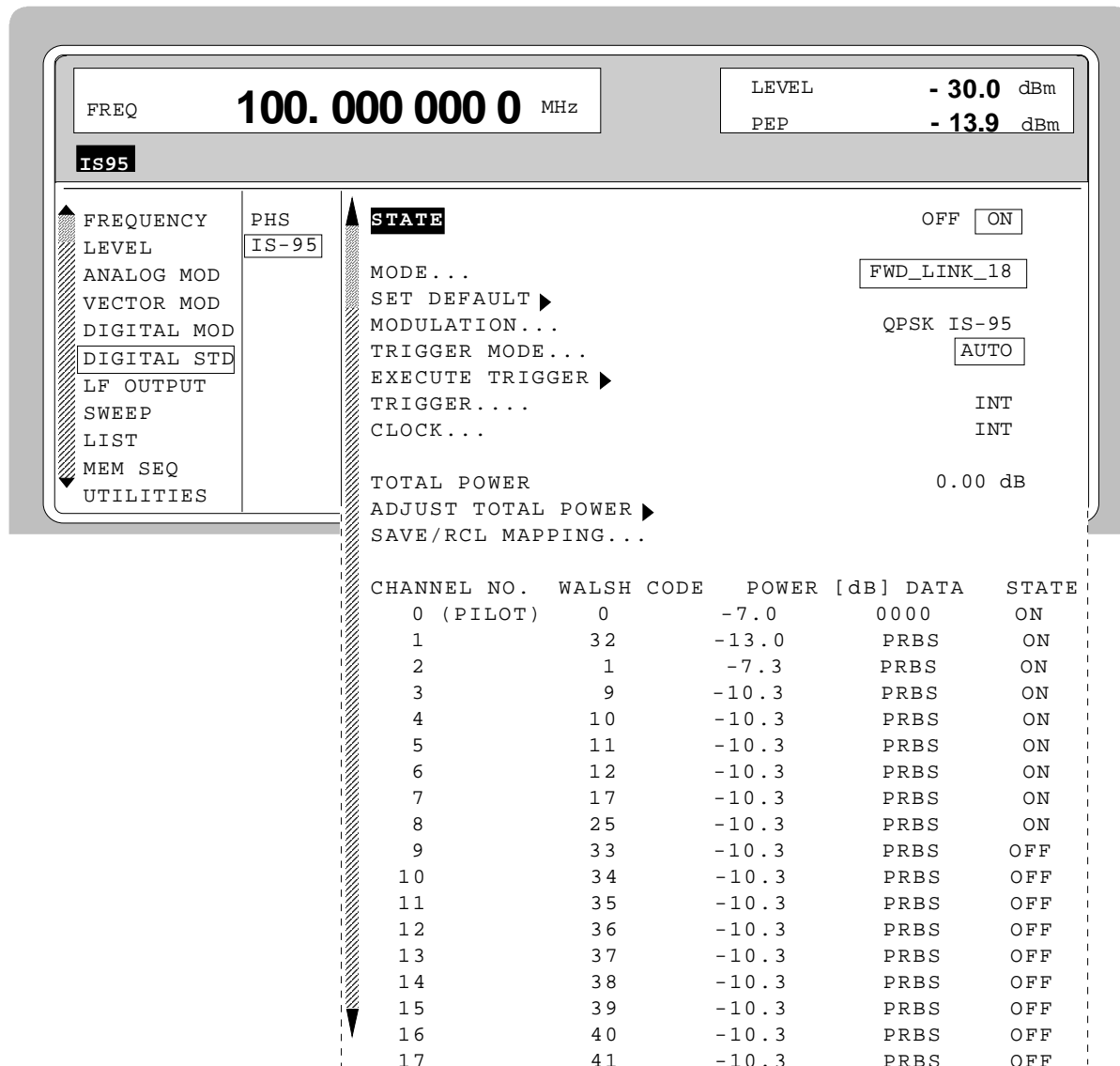

Fig. 2-81 Menu DIGITAL STD - IS-95 - MODE - FWD_LINK_18, equipped with options modulation coder SMIQB20, data generator SMIQB11 and SMIQB42

STATE Switch on/off of modulation Digital Standard IS-95 CDMA. Vector modulation and digital modulation will be switched off automatically.
IEC/IEEE-bus command SOUR:IS95:STAT ON

MODE...	Selection between the different modes for generating a forward link signal or reverse link signals. The REV_LINK modes will be described in the following sections.
FWD_LINK_18	<p>Activates the generation of a forward link signal with up to 18 code channels (channel No. 0 to 17). The Walsh code (WALSH CODE) and the source for modulation data (DATA) can be determined individually for each channel. Each channel can be switched on/off (STATE). The relative power (POWER) of channels 0 (pilot), 1 and 2 can be freely determined in range -30 dB to 0 dB. The power setting of channel 3 also determines the power setting of channels 4 to 17. This means that channels 3 to 17 all have the same power provided when the channels are switched on.</p> <p>IEC/IEEE-bus : SOUR:IS95:MODE FLIN18</p>
FWD_LINK_64	<p>Activates the generation of a forward link signal with up to 64 code channels. Walsh codes 0 to 63 (WALSH CODE) are assigned to the channels. The source for modulation data (DATA) can be determined individually for each channel. Each channel can be switched on/off (STATE). The relative power (POWER) of the pilot channel (Walsh 0) can be freely determined in range -30 dB to 0 dB. The power setting of channel 1 also determines the power setting of channels 2 to 63. This means that channels 1 to 63 all have the same power provided when the channels are switched on.</p> <p>IEC/IEEE-bus : SOUR:IS95:MODE FLIN64</p>
REV_LINK	<p>Activates the generation of a reverse link signal without channel coding. A selection between the full-rate and half-rate mode (RATE) is possible.</p> <p>IEC/IEEE-bus : SOUR:IS95:MODE RLIN</p>
REV_LINK_CODED	<p>Activates the generation of a reverse link signal with channel coding. A selection between the access channel and traffic channel with different rates is possible.</p> <p>IEC/IEEE-bus : SOUR:IS95:MODE RLCO</p>

SET DEFAULT ►

Provides the default setting for the channel configuration of the forward link modes.

For FWD_LINK_18:

- channels 0 to 8 are switched on
 - the power of the pilot channel (channel 0) makes out 20% of the total power (-7 dB).
 - channel 1 is set as sync channel by WALSH CODE 32
 - channel 2 is set as paging channel
 - the remaining 7 channels are configured as traffic channels
- The power setting was selected according to the "Base Station Test Model" of TIA standard IS-97.

For FWD_LINK_64:

- all 64 channels are switched on
- the power of the pilot channel makes out 20% of the total power (-7 dB).
- the remaining 80% of the transmit power is distributed equally on the remaining 63 channels.

IEC/IEEE-bus command : SOUR: IS95: PRES

MODULATION...

Opens a window for setting the modulation parameters.

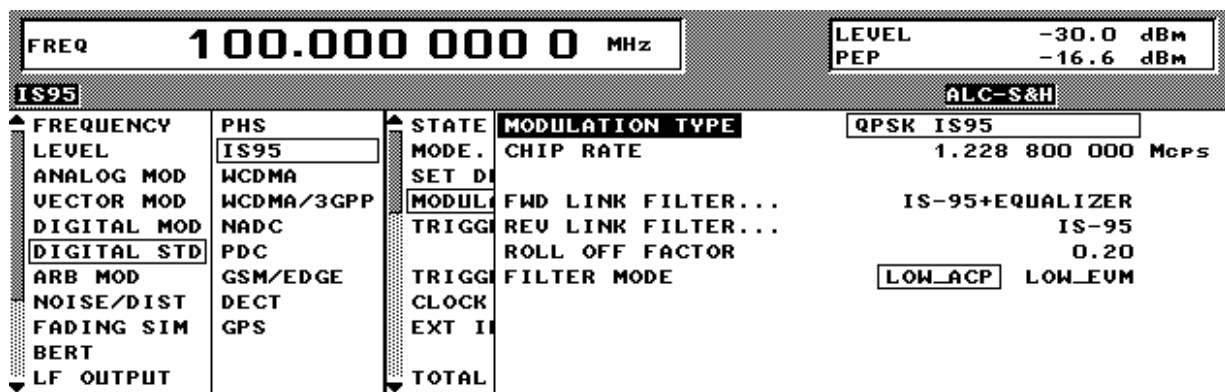

Fig. 2-82 Menu DIGITAL STD - IS-95 - MODULATION..., equipped with options modulation coder SMIQB20, data generator SMIQB11 and SMIQB42

- (MODULATION...)** **MODULATION TYPE** Indicates the modulation type.
- CHIP RATE** Setting value of chip clock frequency.
Preset to 1.2288 Mcps.
IEEE-bus command : SOUR: IS95: CRAT 1.2 MHZ
- (MODULATION...)** **FWD LINK FILTER...** Opens a window for selecting the baseband filters for the forward link. A selection between the FIR filters defined in IS-95, the Nyquist filters COS and SQRCOS or a user-defined filter USER (cf. Section Digital Modulation) is possible. A FIR filter is preset with equalizer according to IS-95.
IEEE command : SOUR: IS95: FILT: FTYP EIS95

REV LINK FILTER...	<p>Opens a window for selecting the baseband filter for the reverse link. A selection between the FIR filters defined in IS-95, the Nyquist filters COS and SQRCOS or a user-defined filter USER (cf. Section Digital Modulation) is possible. A FIR filter is preset according to IS-95.</p> <p>IEEE command : SOUR:IS95:FILT:RTYP IS95</p>
ROLL OFF FACTOR	<p>Setting value of roll-off factor. The setting is only possible provided that a COS or SQRCOS filter is selected under FILTER.</p> <p>IEEE-bus command : SOUR:IS95:FILT:PAR 0.22</p>
FILTER MODE	<p>Selection of filter mode.</p> <p>LOW_ACP Filter for minimum <u>A</u>djacent <u>C</u>hannel <u>P</u>ower. IEEE SOUR:IS95:FILT:MODE LACP</p> <p>LOW_EVM Filter for minimum vector error. IEEE SOUR:IS95:FILT:MODE LEVM</p>

TRIGGER MODE...	Opens a window for selecting the CDMA sequence.
AUTO	The calculated CDMA chip sequence is cyclically repeated. IEC/IEEE-bus command : SOUR:IS95:SEQ AUTO
RETRIG	The CDMA chip sequence is continuously repeated. A trigger event causes a restart from frame 1. IEC/IEEE-bus command : SOUR:IS95:SEQ RETR
ARMED_AUTO	The CDMA chip sequence cannot be started from frame 1 until a trigger event has occurred. The unit then automatically switches over to the AUTO mode and can no longer be triggered. IEC/IEEE-bus command : SOUR:IS95:SEQ AAUT
ARMED_RETRIG	The CDMA chip sequence cannot be started from frame 1 until a trigger event has occurred. each new trigger event causes a restart. IEC/IEEE-bus command : SOUR:IS95:SEQ ARET

EXECUTE TRIGGER ▶ Executes a trigger event to start the CDMA chip sequence.
IEC/IEEE-bus command : TRIG:DM:IMM

TRIGGER... Opens a window for selecting the trigger source, for configuring the trigger output signals and for setting the time delay of an external trigger signal.

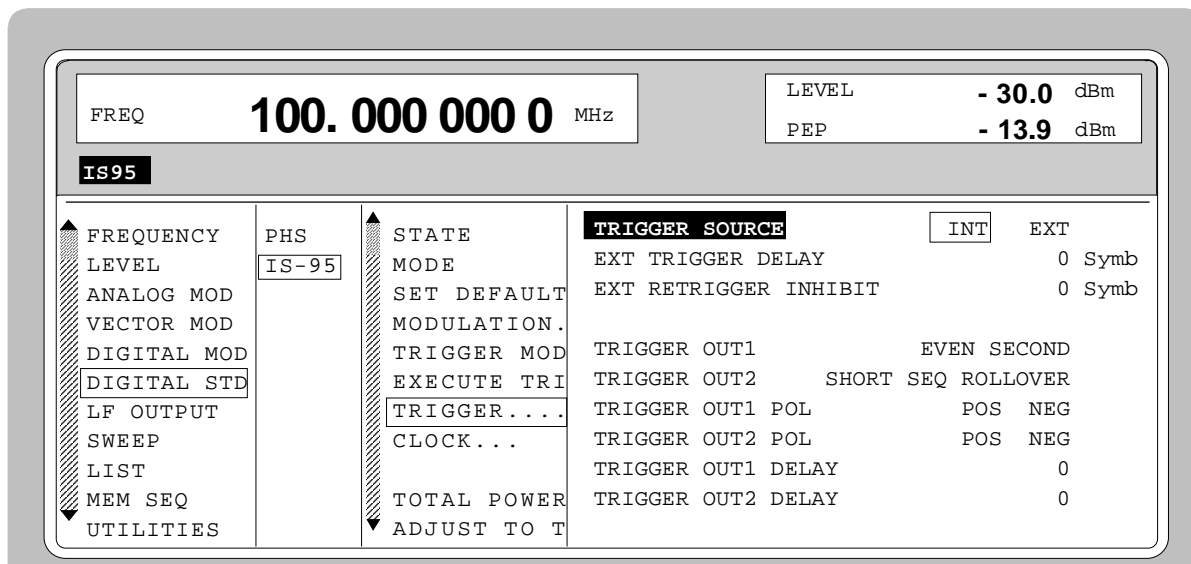

Fig. 2-83 Menu DIGITAL STD - IS-95 - TRIGGER..., equipped with options modulation coder SMIQB20, data generator SMIQB11 and SMIQB42

(TRIGGER...)	TRIGGER SOURCE	<p>Selection of trigger source.</p> <p>EXT The CDMA chip sequence is started from frame 1 by means of the active slope of an external trigger signal. The polarity, the trigger threshold and the input resistance of the TRIGIN input can be modified in menu DIGITAL MOD - EXT INPUTS.</p> <p>INT A trigger event is manually executed by EXECUTE TRIGGER.</p> <p>IEC/IEEE-bus : SOUR: IS95: TRIG: SOUR EXT</p>
	EXT TRIGGER DELAY	<p>Setting the number of chips (symbols) by which an external trigger signal is delayed before it starts the CDMA chip sequence.</p> <p>This is used for setting the time synchronicity between the DUT and other units.</p> <p>IEC/IEEE-bus : SOUR: IS95: TRIG: DEL 3</p>
	EXT RETRIGGER INHIBIT	<p>Setting the number of chips for which a restart is inhibited after a trigger event. With TRIGGER MODE RETRIG selected, each new trigger signal restarts the CDMA chip sequence. This restart can be inhibited for the entered number of chips (symbols).</p> <p>Example: The entry of 98000 symbols, for example, causes new trigger signals to be ignored for the duration of 98000 chips after a trigger event.</p> <p>IEC/IEEE-bus : SOUR: IS95: TRIG: INH 16000</p>
	TRIGGER OUT 1/2	<p>Selection of signals for outputs TRIGOUT 1 and TRIGOUT 2 of connector PARADATA. All the times indicated are valid for a chip rate of 1.2288 Mcps.</p> <p>TRAFFIC FRAME 20-ms frame clock IEC : SOUR: IS95: OUTP1 TFR</p> <p>SHORT SEQ ROLLOVER 80/3-ms clock IEC : SOUR: IS95: OUTP1 SSR</p> <p>SUPER FRAME 80-ms clock IEC : SOUR: IS95: OUTP1 SFR</p> <p>EVEN SECOND 2-s clock IEC : SOUR: IS95: OUTP1 ESEC</p> <p>PCG power control group rate IEC : SOUR: IS95: OUTP1 GATE</p>

(TRIGGER...) **TRIGGER OUT 1/2 POL** Selection of signal polarity at outputs TRIGOUT 1 and TRIGOUT 2 of the PARADATA connector.
 IEC/IEEE-bus : SOUR:IS95:OUTP1:POL NORM

TRIGGER OUT 1/2 DELAY Setting the number of chips by which the selected trigger signal is delayed.
 IEC/IEEE-bus : SOUR:IS95:OUTP1:DEL -50

CLOCK... Opens a window for selecting the clock source.
 The CDMA chip clock in SMIQ corresponds to the symbol clock of the modulation. Therefore, the terms symbol clock and chip clock are synonymous.

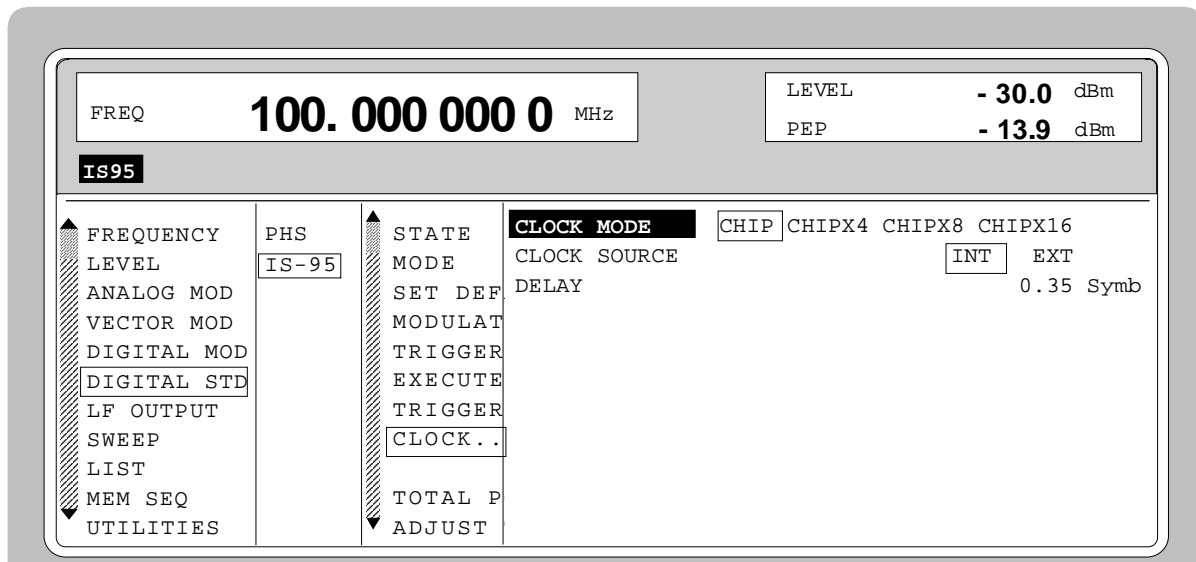

Fig. 2-84 Menu DIGITAL STD - IS-95 - CLOCK..., equipped with options modulation coder SMIQB20, data generator SMIQB11 and SMIQB42

(CLOCK...) **CLOCK MODE** Selection of the type of external clock signal.
 CHIP Chip clock
 CHIPXn Four-, eight- or sixteen-fold chip clock (n=4, 8 or 16).
 IEC/IEEE-bus : SOUR:IS95:CLOC:MODE CHIP

(CLOCK...)	CLOCK SOURCE	<p>Selection of clock source.</p> <p>INT SMIQ uses internally generated clock signals.</p> <p>EXT An external chip clock is fed in at connector SYMBOL CLOCK. Multifolds of the chip clock are fed in at connector BIT CLOCK . The clock synthesizer on the modulation coder is synchronized to this clock. Parameter CHIP RATE has to be set with an accuracy of $\pm 1 \%$. The polarity, the trigger threshold and the input resistance of the SYMBOL CLOCK input can be modified in menu DIGITAL MOD - EXT INPUTS.</p> <p>IEC/IEEE-bus : SOUR : IS95 : CLOC : SOUR INT</p>
	DELAY	<p>Setting the delay of generated modulation signal to an external clock.</p> <p>This can be used, for example, for synchronization with a second unit to achieve time synchronicity between the modulation signals of the two units.</p> <p>The displayed setting resolution of 1/100 symbol is only attained for symbol-clock frequencies below 100 kHz. The resolution is reduced with increasing frequency. At a chip rate of 1.2288 Mcps, the resolution equals the chip duration $\times 0.1$.</p> <p>IEC/IEEE-bus : SOUR : IS95 : CLOC : DEL 0.5</p>
TOTAL POWER		<p>Display of the total power of all active code channels. The TOTAL POWER is calculated when the modulation is active (STATE = ON). It is the sum of the channel power of all active channels. If the value is not equal 0 dB then all active channel power were internally adjusted so that the total power equals 0 dB (the power relation between single code channels is not affected!) This is necessary to keep the setted output power (LEVEL) constant. In addition to this average power (LEVEL) the peak envelope power (PEP) is also indicated in the header of the display. The value for PEP is calculated based on a worst case. The actual peak powers are mostly smaller.</p> <p>IEC/IEEE-bus command : SOUR : IS95 : POW?</p>
ADJUST TOTAL POWER ►		<p>Changes the power of every code channel switched on. After this adjustment the total power is 0 dB. The power relation between single active code channels is not affected.</p> <p>IEC/IEEE-bus command : SOUR : IS95 : POW : ADJ</p>

SAVE/RCL MAPPING...

Saves/calls up the set channel configuration.
This setting is only possible in the forward link mode.

For FWD_LINK_18, the following is saved for each channel number:

- selected WALSH CODE
- set POWER
- type of modulation data (DATA) and
- switch-on state.

For FWD_LINK_64, the following is saved for each channel number:

- set POWER
- modulation data (DATA) and
- switch-on state.

The channel configuration of the two forward-link modes is stored and loaded at the same time.

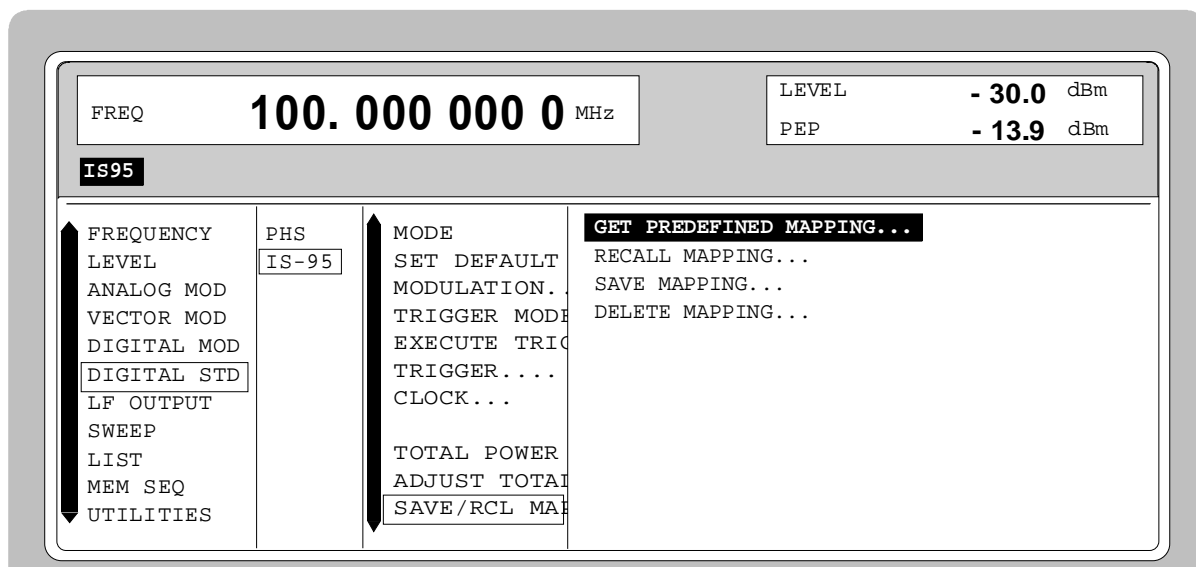

Fig. 2-85 Menu DIGITAL STD - IS-95 - SAVE/RCL MAPPING..., equipped with options modulation coder SMIQB20, data generator SMIQB11 and SMIQB42

(SAVE/RCL MAPPING...)

GET PREDEFINED MAPPING...

Loads a factory-set channel configuration.
 PILOT A pilot signal is generated only.
 09CHAN A signal with 9-code channels is generated according to the Base Station Test Model (IS95).
 18CHAN A signal with 18-code channels is generated.
 IEEE-bus :SOUR:IS95:MAPP:SEL:PRED "pilot"

RECALL MAPPING...

Loads a stored channel configuration.
 IEEE-bus :SOUR:IS95:MAPP:LOAD "name"

(SAVE/RCL MAPPING...)	SAVE MAPPING...	Stores the channel configuration. For remote control, a name with 7 characters at max. can be used. IEEE-bus : SOUR: IS95: MAPP: STOR "name"
	DELETE MAPPING...	Deletes a stored channel configuration. IEEE bus : SOUR: IS95: MAPP: DEL "name"
CHANNEL NO	Display of channel number. This menu column is only displayed in the forward link mode.	
WALSH CODE	Setting the Walsh code. This menu column is only displayed in the forward link mode. For FWD_LINK_18 - the Walsh code can be set individually for each channel. IEC/IEEE-bus command : SOUR: IS95: CHAN1: WALSH 32 For FWD_LINK_64 - the Walsh code cannot be set. In this mode, the Walsh code corresponds to the channel number. All the 64 code channels are displayed.	
POWER	Setting the power of channel. This menu column is only displayed in the forward link mode. POWER indicates the average power of the code channel relative to the power indicated in LEVEL display (code domain power). For FWD_LINK_18 - the power of channels 0, 1, 2 is set individually. - the other channels have the same power. The power for all the channels is set in channel 3. For FWD_LINK_64 - the power of the pilot channel is set individually. - the other channels have the same power. The power for all the channels is set in channel 1. IEC/IEEE-bus command : SOUR: IS95: CHAN1: POW -10 DB	
DATA	Setting the modulation data for the selected code channel. This menu column is only displayed in the forward link mode. The data rate for all forward link channels corresponds to the chip rate/64, ie 19200 bps at a chip rate of 1.2288 Mcps 0000 Continuous sequence of zeros IEC/IEEE-bus command SOUR: IS95: CHAN1: DATA ZERO 1111 Continuous sequence of ones IEC/IEEE-bus command SOUR: IS95: CHAN1: DATA ONE 1010 Alternating sequence of zeros and ones IEC/IEEE-bus command SOUR: IS95: CHAN1: DATA ALT PRBS Pseudo random data, different in every code channel IEC/IEEE-bus command SOUR: IS95: CHAN1: DATA PRBS	
STATE	Switch on/off of assigned code channel. This menu column is only displayed in the forward link mode. IEC/IEEE-bus command : SOUR: IS95: CHAN1: STAT ON	

2.12.5 Menu IS-95 CDMA Standard - Reverse Link Signal without Channel Coding

Menu DIGITAL STD - IS-95 provides access to settings for IS-95 CDMA signal generation. The following figure shows the menu for generating the reverse link signal (transmit signal of mobile station) without signal coding. The previous section showed the menu for generating the forward link signals as well as the parameters that are identical for both modes.

Menu selection: DIGITAL STD - IS-95- MODE - REV_LINK

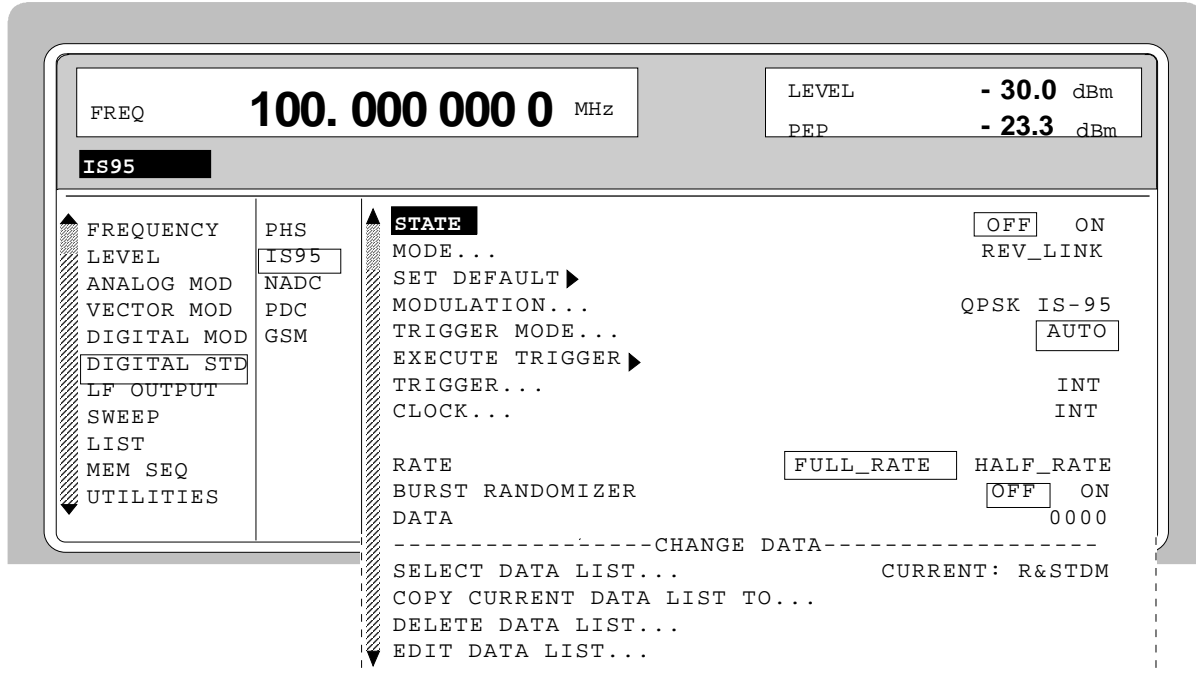

Fig. 2-86 Menu DIGITAL STD - IS-95 - MODE - REV_LINK

- STATE to CLOCK** see section "Menu IS-95 CDMA-Standard- Forward Link Signal"
- RATE** Selection of full-rate or half-rate transmission of modulation data. This selection is only possible in the reverse link mode. In the half-rate mode, only 8 of 16 power control groups of a frame are transmitted ("power gating").
IEC/IEEE-bus command : SOUR: IS95: RATE HALF
- BURST RANDOMIZER** Switch on/off of burst randomizer. This selection is only possible during half-rate transmission in the reverse link mode.
OFF Every second power control group is transmitted.
ON A random algorithm determines which eight of the 16 power control groups of a frame will be transmitted.
IEC/IEEE-bus command : SOUR: IS95: RAND ON

DATA	Selection of modulation data for the reverse link signal. The data rate corresponds to the chip rate x3/128, ie 28800 bps at 1.2288 Mcps.
0000	Continuous sequence of zeros IEC/IEEE-bus : SOUR : IS95 : DATA ZERO
1111	Continuous sequence of ones IEC/IEEE-bus : SOUR : IS95 : DATA ONE
1010	Alternating zeros and ones IEC/IEEE-bus : SOUR : IS95 : DATA ALT
PRBS	PRBS data. IEC/IEEE-bus : SOUR : IS95 : DATA PRBS
DLIST	Data from a programmable data list. IEC/IEEE-bus : SOUR : IS95 : DATA DLIS
SELECT DATA LIST...	Opens a window for selecting a stored data list or for generating a new list (only with Reverse Link or Reverse Link Coded modes).
COPY CURRENT DATA LIST TO...	Stores the current data list under a different name (only with Reverse Link or Reverse Link Coded modes).
DELETE DATA LIST...	Deletes a data list (only with Reverse Link or Reverse Link Coded modes).
EDIT DATA LIST...	Opens a window for editing a data list bit-by-bit. The available storage capacity and the length of the current list is displayed in parameters FREE and LEN (see also Section List Editor). Only with Reverse Link or Reverse Link Coded modes.
COPY	Copies a list range
FILL	Fills the range with filler pattern
INSERT	Inserts a list range at a different position of the list
DELETE	Deletes a list range
EDIT/VIEW	Edits or views the list

2.12.6 Menu IS-95 CDMA Standard - Reverse Link Signal with Channel Coding

Menu DIGITAL STD - IS-95 provides access to settings for generating IS-95 CDMA signals. The following figure shows the menu for generating a reverse link signals with channel coding. The section on the menu for forward link signal generation shows the parameters that are identical for both modes.

Menu selection: DIGITAL STD - IS-95- MODE - REV_LINK_CODED

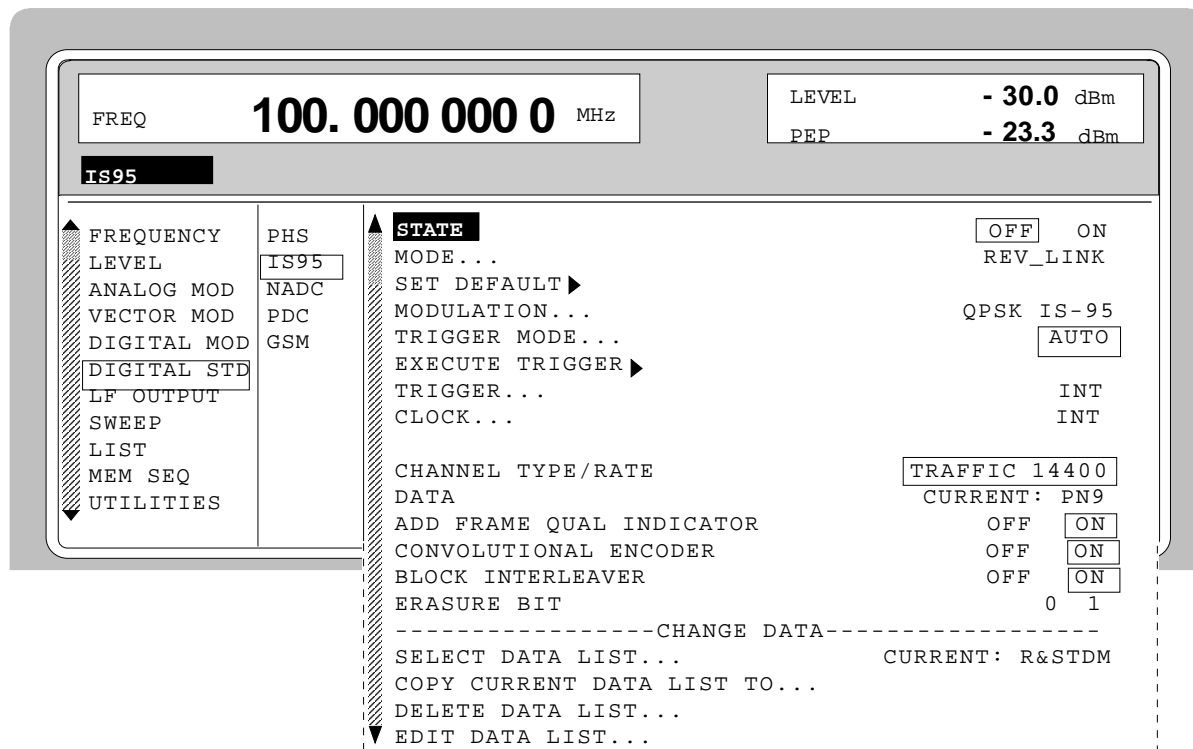

Fig. 2-87 Menu DIGITAL STD - IS-95 - MODE - REV_LINK_CODED

Parameter STATE to CLOCK... see section "Menu IS-95 CDMA Standard - Forward Link Signal".

CHANNEL TYPE/RATE	<p>Selects the type of channel and the associated data rate. This selection is only possible in the reverse link mode. The selection also determines the structure of the channel coding and the number of data bits to be inserted into each frame.</p> <p>TRAFFIC 14400 Traffic channel with 14400 bps. 267 bits are inserted into each frame</p> <p>TRAFFIC 7200 Traffic channel with 7200 bps. 125 bits are inserted into each frame</p> <p>TRAFFIC 3600 Traffic channel with 3600 bps. 55 bits are inserted into each frame</p> <p>TRAFFIC 1800 Traffic channel with 1800 bps. 21 bits are inserted into each frame</p> <p>ACCESS 4800 Access channel with 4800 bps. 88 bits are inserted into each frame</p> <p>TRAFFIC 9600 Traffic channel with 9600 bps. 172 bits are inserted into each frame</p> <p>TRAFFIC 4800 Traffic channel with 4800 bps. 80 bits are inserted into each frame</p> <p>TRAFFIC 2400 Traffic channel with 2400 bps. 40 bits are inserted into each frame</p> <p>TRAFFIC 1200 Traffic channel with 1200 bps. 16 bits are inserted into each frame</p> <p>IEC/IEEE-bus : SOUR: IS95:RLC:CTYP TRAF7200 : SOUR: IS95:RLC:CTYP ACC4800</p>
DATA SOURCE	<p>Selects the modulation data for the reverse link signal with channel coding. The data are continuously inserted into the data field of the corresponding frame.</p> <p>PN.. PRBS data to CCITT with period length between 2^9-1 and $2^{23}-1$. IEC/IEEE-bus command : SOUR: IS95:RLC:DATA PN1</p> <p>DLIST Data from a previously programmed and stored data list. IEC/IEEE-bus command : SOUR: IS95:RLC:DATA DLIST</p>
ADD FRAME QUAL INDICATOR	<p>Switches the frame quality indicator (CRC calculation) on or off. With OFF selected, only zeros are sent instead of CRC bits.</p> <p>IEC/IEEE-bus command : SOUR: IS95:RLC:FQIN ON</p>
CONVOLUTIONAL ENCODER	<p>Switches the convolutional encoder on or off. With OFF selected, the data rate is attained by repeating the symbol.</p> <p>IEC/IEEE-bus command : SOUR: IS95:RLC:CENC ON</p>
BLOCK INTERLEAVER	<p>Switches the interleaver function on or off.</p> <p>IEC/IEEE-bus command : SOUR: IS95:RLC:BINT ON</p>
ERASURE BIT	<p>Selects 1 or 0 for the erasure bit.</p> <p>IEC/IEEE-bus command : SOUR: IS95:RLC:EBIT 0</p>

Parameter **SELECT DATA LIST...** to **EDIT DATA LIST...** see section "Menu IS-95 CDMA Standard - Forward Link Signal"

2.13 Digital Standard W-CDMA (NTT DoCoMo/ARIB 0.0)

With the options Modulation Coder (SMIQB20), Data Generator (SMIQB11) and option Digital Standard W-CDMA (SMIQB43) provided, W-CDMA signals can be generated according to the Japanese experimental system NTT DoCoMo or the ARIB 0.0 standard¹.

SMIQ can simulate both the transmit signal of a base station (Downlink), and the transmit signal of a mobile station (Uplink) with up to 15 code channels.

Different physical channel types such as Perch, Common Control or Dedicated Physical Channel can be selected. For this purpose, SMIQ generates modulation data with the frame structure specified in the standard (framed data). Data fields with pilot symbols, TPC symbols (Traffic Power Control) or LMS symbols (Long Code Mask) are automatically generated. Freely programmable data lists or pseudo-random bit sequences (PRBS) can be used for the modulation symbols in the DATA fields. These modulation data are not subjected to any channel coding (convolution coding, interleaving). The user can, however, store channel-coded modulation data in a data list to generate a logic channel, eg a Dedicated Traffic Channel.

The following figure shows the schematic of forward link signal generation.

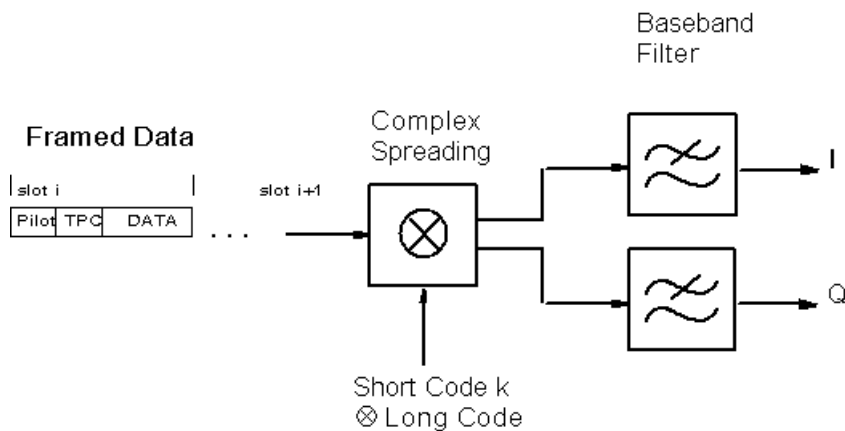

Fig. 2-88 Downlink DPCH signal generation for a code channel

The Perch Channel, DPCH (Dedicated Physical Channel) and CCPCH (Common Control Physical Channel) are available as channel types in the downlink. The data rate for modulation data (framed data) of the DPCH can be selected (32, 64, to 1024 ksymbol/s). The type of modulation is QPSK, but O-QPSK can also be set. A root cosine filter with roll-off factor 0.22 is preset for baseband filtering. Other filters can also be set (MODULATION FILTER). The chip rate is preset to 4.096 Mcps but can be modified within wide limits.

Two modes (LINK DIRECTION/MULTIPLEX) are available to generate an uplink signal. A mobile station transmitter of the Japanese W-CDMA experimental system is simulated in the UP mode. The frame structure of data corresponds to that of the downlink. DPCH and CCPCH are available as channel types.

¹ Association of Radio Industries and Businesses (ARIB), Specifications of Air-Interface for a 3 G Mobile System

A mobile station transmitter in line with the ARIB standard is simulated in the UP_IQ_MULT mode. Separate channel types and data sources for I and Q are available in the multiplex mode.

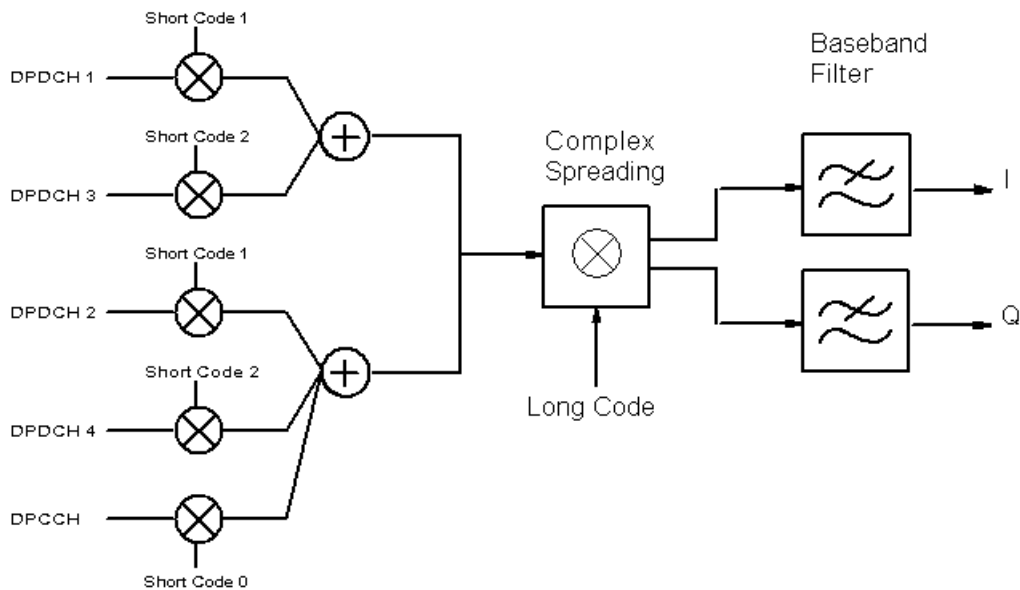

Fig. 2-89 Uplink signal generation with IQ multiplex and several code channels

According to ARIB, DPDCH (Dedicated Physical Data Channel) and DCPCH (Dedicated Control Physical Channel) are available as channel types in the uplink. The data rate for modulation data (framed data) of the DPDCH can be selected (16, 32, 64, to 1024 ksymbol/s).

The modulation data are not calculated in real time in SMIQ. On the user request, a W-CDMA chip sequence is calculated (STATE = ON) and then stored in the data memory of the data generator (option SMIQ B11). The sequence length is settable (SEQUENCE LENGTH [FRAMES]), the maximum possible length depends on the memory capacity of the data generator.

A special multicode mode is available (MULTICODE) for LINK DIRECTION/MULTIPLEX DOWN and UP modes. The data fields Pilot and TPC have the same settings and are spread with the same spreading codes of the MASTER CHANNEL.

2.13.1 Sync and Trigger Signals

A chip sequence is calculated for the generation of W-CDMA signals and stored in the memory of the data generator (option SMIQB11). This chip sequence can be run repetitively (TRIGGER MODE AUTO).

Trigger signals can be used for synchronized measurements on receivers (TRIGGER MODE RETRIG, ARMED_AUTO or ARMED_RETRIG).

A trigger signal can be fed via the TRIGIN input at connector PAR DATA of SMIQ. The chip sequence either starts immediately after the active slope of the trigger signal or after a settable number of chips (EXT TRIGGER DELAY). Retriggering (RETRIG) can be inhibited for a settable number of chips (EXT RETRIGGER INHIBIT).

A trigger event can be executed manually or via the IEC/IEEE bus using EXECUTE TRIGGER. When a trigger event is executed, a trigger signal is output at the TRIGOUT 3 output of SMIQ.

SMIQ generates the following sync signals:

- a 0.625 ms slot clock
- a 10 ms radio frame clock
- a marker signal for identifying the periodic repetition of the generated chip sequence

SMIQ can output two of the three signals via pins TRIGOUT 1 and 2 of connector PAR DATA.

A clock synthesizer on the modulation coder generates the chip clock in the SMIQ. All the clock signals are synchronized to the 10-MHz reference of the SMIQ. The chip clock is available at connector SYMBOL CLOCK. If required, the clock synthesizer in the SMIQ can be synchronized to an external chip clock which is fed in at connector SYMBOL CLOCK.

To allow for a trouble-free synchronization of the clock synthesizer first apply the external clock and set the correct chip rate at SMIQ (MODULATION - CHIPRATE VARIATION). Then switch CLOCK SOURCE from INT to EXT.

Note: *The set symbol rate should not differ by more than 1% from the symbol rate of the external signal.*

2.13.2 PN Generators as Internal Data Source

Different PN (Pseudo Noise) generators can be selected as data source for DATA fields. These PN generators provide pseudo random bit sequences of different lengths or periods which is why they are also called PRBS generators (Pseudo Random Binary Sequence).

The data sequences are so-called sequences of maximum lengths that are generated by means of feedback shift registers.

The following schematic shows the 9 bit generator with feedback to registers 4 and 0 (output).

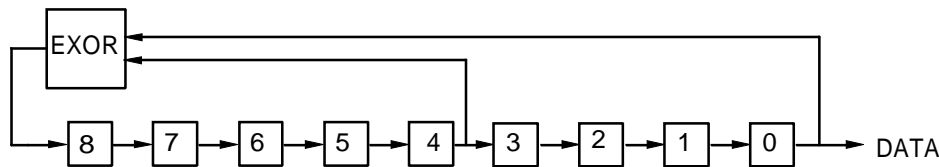

The pseudo random sequence of a PRBS generator is determined by the number of registers and the feedback. The following table describes all available PRBS generators:

Table 2-17 PN generators for W-CDMA

PRBS generator	Length in bits	Feedback to	Start value (*)
9 bits	$2^9 - 1 = 511$	Register 4, 0	Channel 0: 0000 0100 1 Channel 1: 1000 0100 1 Channel 2: 0100 0100 1 Channel 3: 1100 0100 1 ... Channel 15: 1111 0100 1
11 bits	$2^{11} - 1 = 2047$	Register 2, 0	Channel 0: 0000 0100 100 ... Channel 15: 1111 0100 100
15 bits	$2^{15} - 1 = 32767$	Register 1, 0	Channel 0: 0000 0100 1000 000 ... Channel 15: 1111 0100 1000 000
16 bits	$2^{16} - 1 = 65535$	Register 5, 3, 2, 0	Channel 0: 0000 0100 1000 0000 ... Channel 15: 1111 0100 1000 0000

*) the 5th start value bit of channels in Q phase is 1 (for example: channel 3: 1100 1100 1...)

PN generators PN9,11 and PN15 are designed according to CCITT Rec. 0.151/152/153. The output sequence is inverted for generator PN15.

Example: PN9 generator in channel 3 with start value 110001001 (binary)

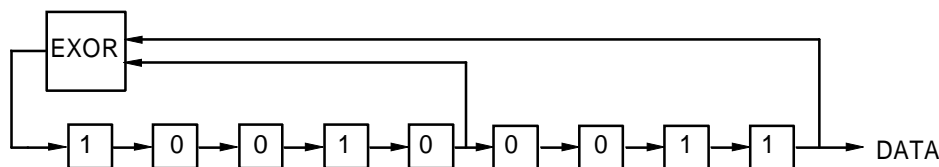

The resulting output sequence is 110001001100010001000 etc.

2.13.3 Lists as an Internal Data Source

A freely programmable memory can be used as a data source for DATA or TPC fields. The data are managed in lists. A list editor enables the data lists (DATA LIST) to be selected, copied, modified and erased. The list editor can be accessed via the menu DIGITAL MOD SOURCE...

2.13.4 Menu W-CDMA Standard - Downlink and Uplink Signals without IQ Multiplex

Menu DIGITAL STD - W-CDMA provides access to settings for W-CDMA signal generation. The figure below shows an example of the menu for generating the downlink signal (transmit signal of the base station) in the 8CHAN mode. The menus for generating uplink signals without IQ multiplex have nearly the same structure. A menu for generating uplink signals with IQ multiplex is shown in the next section. Parameters that are identical for all modes are explained in this section.

Menu selection: DIGITAL STD - WCDMA - MODE - 8CHAN, -LINK DIRECTION/MULTIPLEX DOWN

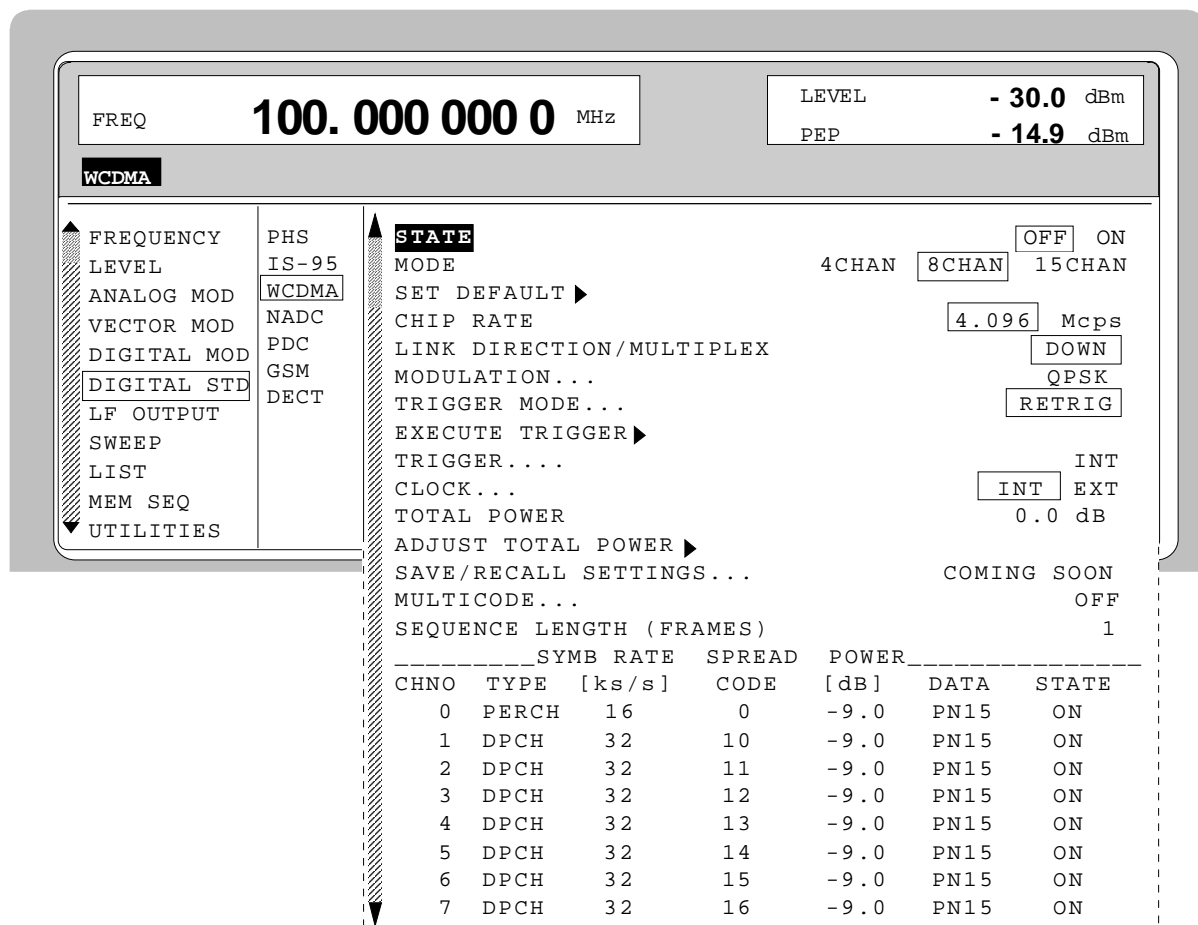

Fig. 2-90 Menu DIGITAL STD - WCDMA - MODE - 8CHAN, LINK DIRECTION/MULTIPLEX - DOWN, equipped with options modulation coder SMIQB20, data generator SMIQB11 and SMIQB43

STATE	<p>Switch on/off of modulation Digital Standard W-CDMA. Vector modulation and digital modulation will be switched off automatically.</p> <p>STATE = ON starts the calculation of a chip sequence based on the current settings. The length of the chip sequence and therefore the duration of calculation are determined by parameter SEQUENCE LENGTH.</p> <p>IEC/IEEE-bus command : SOUR:WCDM:STAT ON</p>
MODE...	<p>Opens a window for selecting from the different modes to determine the number of code channels.</p> <p>The physical channel type (TYPE), the symbol rate, some spreading parameters (SPREAD CODE) and the source for modulation data (DATA) can be separately defined for each channel. Each channel can be switched on or off (STATE).</p>
4CHAN	<p>Activates the generation of a signal with up to 4 code channels (channel No. 0 to 3). The relative power (POWER) of the channels can be freely determined in range -30 dB to 0 dB.</p> <p>IEC/IEEE-bus : SOUR:WCDM:MODE CHAN4</p>
8CHAN	<p>Activates the generation of a signal with up to 8 code channels (channel No. 0 to 7). The relative power (POWER) of channel 0 can be freely determined in range -30 dB to 0 dB. The power setting of channel 1 also determines the power setting of channels 2 to 7. This means that channels 1 to 7 all have the same power provided when the channels are switched on.</p> <p>IEC/IEEE-bus : SOUR:WCDM:MODE CHAN8</p>
15CHAN	<p>Activates the generation of a signal with up to 15 code channels (channel No. 0 to 14). The relative power of channels cannot be freely defined since all activated code channels have the same power. The relative power is displayed (POWER).</p> <p>IEC/IEEE-bus : SOUR:WCDM:MODE CHAN15</p>

SET DEFAULT ►

Provides the default setting for W-CDMA.

For LINK DIRECTION/MULTIPLEX DOWN

- in mode 8, channel 0 is a Perch channel, it is switched on and its symbol rate is 16 ksymbol/s
- all other channels are also switched on (STATE ON), channel type (TYPE) is DPCH, symbol rate is 32 ksymbol/s
- the channels have the same relative power (POWER)
- the data are pseudo random (PN15), except for Perch channel, a data offset of three times the channel number ($3 \bullet \text{CHNO}$) is set.

For LINK DIRECTION/MULTIPLEX UP

- only channel 0 is switched on, channel type is DPCH, symbol rate is 32 ksymbol/s
- the data are pseudo random (PN15), no data offset is set.

For LINK DIRECTION/MULTIPLEX UP_IQ_MULT

- all channels are switched on except I-channel 0 in mode 8
- Q-channel 0 is configured as DPCCH, all the other channels are configured as DPDCH with a symbol rate of 16 ksymbol/s
- all channels have the same relative power (POWER)
- the data are pseudo random (PN15), no data offset is set.

IEC/IEEE-bus : SOUR : WCDM : PRES

CHIP RATE

Selection between 4.096 Mcps and 8.192 Mcps. Selecting 8.192 Mcps depends on the hardware configuration of the unit and is not offered yet. Selecting CHIP RATE has an effect on the generation of spreading codes and thus on the calculated chip sequence.

IEC/IEEE-bus : SOUR : WCDM : CRAT R4M

**LINK DIRECTION/
MULTIPLEX**

Opens a window for selecting the type of transmit signal from the different modes.

DOWN

Activates the generation of a downlink signal. In this mode, the transmit signal of a base station can be generated in line with the Japanese ARIB standard or according to NTTDoCoMo specifications for an experimental system.

IEC/IEEE-bus : SOUR : WCDM : LINK DOWN

UP

Activates the generation of an uplink signal. In this mode, the transmit signal of a mobile station can be generated in line with the NTTDoCoMo specifications for an experimental system.

IEC/IEEE-bus : SOUR : WCDM : LINK UP

UP_IQ_MULT

Activates the generation of an uplink signal with a multiplex mode for the I and Q channel. Separate channel types and data sources are available for I and Q. In this mode, the transmit signal of a mobile station can be generated in line with the Japanese ARIB standard.

IEC/IEEE-bus : SOUR : WCDMA : LINK UPM

MODULATION... Opens a window for setting the modulation parameters.

Menu selection: DIGITAL STD - WCDMA - MODULATION...

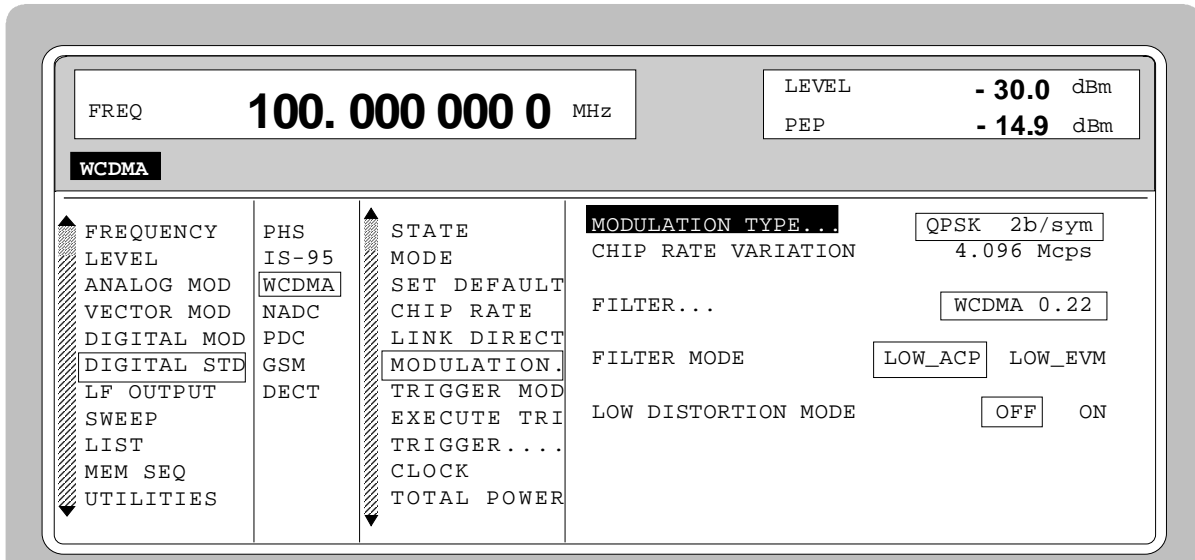

Fig. 2-91 Menu DIGITAL STD - WCDMA - MODULATION..., equipped with options modulation coder SMIQB20, data generator SMIQB11 and SMIQB43

(MODULATION...)	MODULATION TYPE	Selection between the types of modulation QPSK and offset QPSK. IEC/IEEE-bus : SOUR:WCDM:FORM QPSK
	CHIP RATE VARIATION	Setting value for the chip clock frequency. The value for CHIPRATE from the main menu is preset. CHIP RATE VARIATION modifies the output clock and the modulation bandwidth as well as the output synchronization signals. It has no effect on the calculated chip sequence. IEC/IEEE-bus : SOUR:WCDM:CRAT:VAR 4096001
	FILTER...	Opens a window for selecting the baseband filter. Selection can be made between a filter optimized for W-CDMA, the standard Nyquist filters COS and SQR COS or a user-defined filter USER (cf. Section Digital Modulation) is possible. The optimized root cosine filter WCDMA 0.22 is preset. Its roll-off factor is fixed to 0.22. IEC/IEEE-bus : SOUR:WCDM:FILT:TYPE WCDM
	ROLL OFF FACTOR	Setting value of roll-off factor. The setting is only possible provided that a COS or SQR COS filter is selected under FILTER. IEC/IEEE-bus : SOUR:WCDM:FILT:PAR 0.22

(MODULATION...)	FILTER MODE	<p>Selection of filter mode.</p> <p>LOW_ACP Filter for minimum <u>A</u>djacent <u>C</u>hannel <u>P</u>ower.</p> <p style="padding-left: 40px;">IEC/IEEE-bus command : SOUR:WCDM:FILT:MODE LACP</p> <p>LOW_EVM Filter for minimum vector error.</p> <p style="padding-left: 40px;">IEC/IEEE-bus command : SOUR:WCDM:FILT:MODE LEVM</p>
	LOW DISTORTION MODE	<p>Switch on/off of low-distortion mode.</p> <p>After switch-on, the level of the IQ baseband signals is reduced by 3 dB. In some cases, this might reduce undesired intermodulation products. OFF is normally the more favourable setting.</p> <p style="padding-left: 40px;">IEC/IEEE-bus : SOUR:WCDM:LDIS:STAT OFF</p>
TRIGGER MODE	Opens a window for selecting the W-CDMA sequence.	
	AUTO	<p>The calculated W-CDMA chip sequence is cyclically repeated.</p> <p style="padding-left: 40px;">IEC/IEEE-bus command : SOUR:WCDM:SEQ AUTO</p>
	RETRIG	<p>The W-CDMA chip sequence is continuously repeated. A trigger event causes a restart from frame 1.</p> <p style="padding-left: 40px;">IEC/IEEE-bus command : SOUR:WCDM:SEQ RETR</p>
	ARMED_AUTO	<p>The W-CDMA chip sequence cannot be started from frame 1 until a trigger event has occurred. The unit then automatically switches over to the AUTO mode and can no longer be triggered.</p> <p style="padding-left: 40px;">IEC/IEEE-bus command : SOUR:WCDM:SEQ AAUT</p>
	ARMED_RETRIG	<p>The W-CDMA chip sequence cannot be started from frame 1 until a trigger event has occurred. each new trigger event causes a restart.</p> <p style="padding-left: 40px;">IEC/IEEE-bus command : SOUR:WCDM:SEQ ARET</p>
EXECUTE TRIGGER ►	Executes a trigger event to start the W-CDMA chip sequence.	
		IEC/IEEE-bus command : TRIG:DM:IMM
TRIGGER...	Opens a window for selecting the trigger source, for configuring the trigger output signals and for setting the time delay of an external trigger signal.	

Menu selection: DIGITAL STD - WCDMA - TRIGGER...

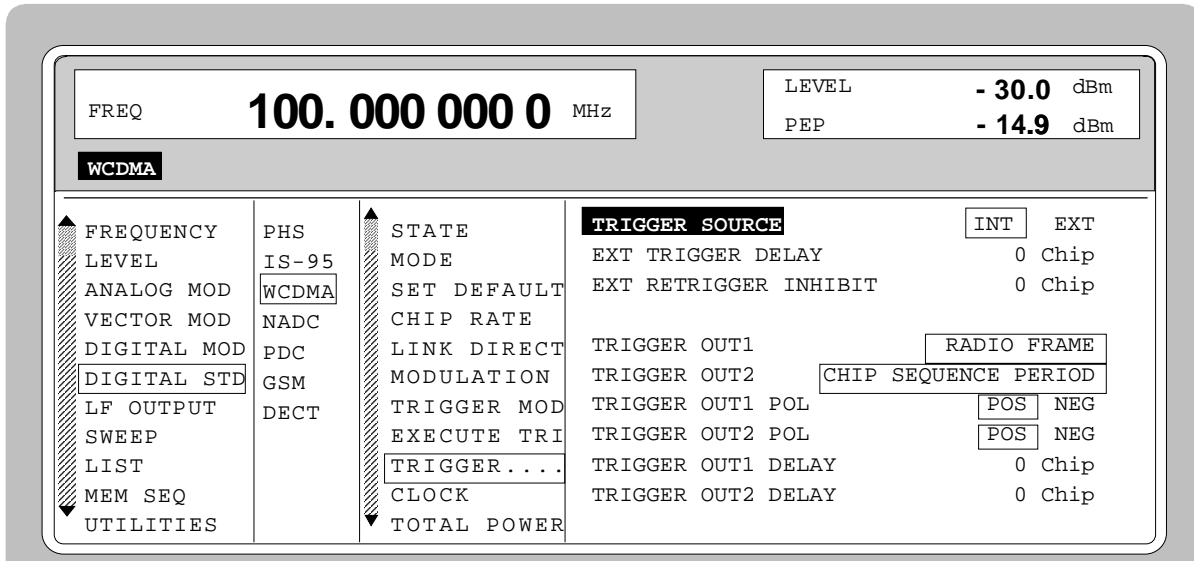

Fig. 2-92 Menu DIGITAL STD - WCDMA - TRIGGER..., equipped with options modulation coder SMIQB20, data generator SMIQB11 and SMIQB43

TRIGGER...	TRIGGER SOURCE	<p>Selection of trigger source.</p> <p>EXT The W-CDMA chip sequence is started from frame 1 by means of the active slope of an external trigger signal. The polarity, the trigger threshold and the input resistance of the TRIGIN input can be modified in menu DIGITAL MOD - EXT INPUTS.</p> <p>INT A trigger event is manually executed by EXECUTE TRIGGER.</p> <p>IEC/IEEE-bus : SOUR:WCDM:TRIG:SOUR EXT</p>
	EXT TRIGGER DELAY	<p>Setting the number of chips by which an external trigger signal is delayed before it starts the W-CDMA chip sequence. This is used for setting the time synchronicity between the DUT and other units.</p> <p>IEC/IEEE-bus : SOUR:WCDM:TRIG:DEL 3</p>
	EXT RETRIGGER INHIBIT	<p>Setting the number of chips for which a restart is inhibited after a trigger event. With TRIGGER MODE RETRIG selected, each new trigger signal restarts the W-CDMA chip sequence. This restart can be inhibited for the entered number of chips.</p> <p>Example: The entry of 82000 chips, for example, causes new trigger signals to be ignored for the duration of 82000 chips after a trigger event.</p> <p>IEC/IEEE-bus : SOUR:WCDM:TRIG:INH 82000</p>

(TRIGGER...)	TRIGGER OUT 1/2	<p>Selection of signals for outputs TRIGOUT 1 and TRIGOUT 2 of connector PARADATA. The time specifications are valid only if the frequency of the internal clock generation is not modified with the parameter CHIP RATE VARIATION.</p> <p>SLOT 0.625 ms time slot clock IEC/IEEE-bus : : SOUR:WCDM:TRIG:OUTP1 SLOT</p> <p>RADIO FRAME 10 ms frame clock IEC/IEEE-bus : : SOUR:WCDM:TRIG:OUTP1 RFR</p> <p>CHIP SEQUENCE PERIOD Marker signal for identifying the periodic repetition of the generated chip sequence IEC/IEEE-bus : : SOUR:WCDM:TRIG:OUTP1 CSP</p>
	TRIGGER OUT 1/2 POL	<p>Selection of signal polarity at outputs TRIGOUT 1 and TRIGOUT 2 of the PARADATA connector. IEC/IEEE-bus : SOUR:WCDM:OUTP2:POL POS</p>
	TRIGGER OUT 1/2 DELAY	<p>Setting the number of chips by which the selected trigger signal is delayed. IEC/IEEE-bus : SOUR:WCDM:OUTP2:DEL 0</p>
CLOCK...		<p>Enables the selection of the clock source of the chip clock.</p> <p>INT SMIQ uses internally generated clock signals.</p> <p>EXT A chip clock should externally be applied to connector SYMBOL CLOCK. Parameter CHIP RATE should be correctly set with a precision of ± 1 %. The polarity, the trigger threshold and the input resistance of the SYMBOL CLOCK input can be modified in menu DIGITAL MOD - EXT INPUTS. IEC/IEEE-bus : SOUR:WCDM:CLOC:SOUR INT</p>
TOTAL POWER		<p>Display of the total power of all active code channels. The TOTAL POWER is calculated when the modulation is active (STATE = ON). It is the sum of the channel power of all active channels. If the value is not equal 0 dB then all active channel power were internally adjusted so that the total power equals 0 dB (the power relation between single code channels is not affected!) This is necessary to keep the setted output power (LEVEL) constant. In addition to this average power (LEVEL) the peak envelope power (PEP) is also indicated in the header of the display. The value for PEP is calculated based on a worst case. The actual peak powers are mostly smaller. IEC/IEEE-bus command : SOUR:WCDM:POW?</p>
ADJUST TOTAL POWER ►		<p>Changes the power values of all activated code channels. After this adjustment the total power is 0 dB. The power relation between single active code channels is not affected. IEC/IEEE-bus command : SOUR:WCDM:POW:ADJ</p>

Menu selection: DIGITAL STD - WCDMA - MULTICODE...

Fig. 2-93 Menu DIGITAL STD - WCDMA - MULTICODE..., equipped with options modulation coder SMIQB20, data generator SMIQB11 and SMIQB43

MULTICODE...

Opens a window for selecting multicode settings. The multicode mode cannot be activated in the LINK DIRECTION/MULTIPLEX UP-IQ_MULT mode. In the multicode mode, the data fields Pilot and TPC have the same settings and are spread with the same spread codes of the MASTER CHANNEL for all selected code channels.

STATE

Switch on/off the multicode mode.

IEC/IEEE-bus : SOUR:WCDM:MULT:STAT ON

MASTER CHANNEL

Selection of the master channel. This channel defines spread code and contents for data fields Pilot and TPC in all multicode channels. The selection also causes that parameters LONG CODE INIT, LONG CODE OFFSET, SYMBOL RATE and DATA OFFSET of the selected multicode channels are set to the same values as the master channel.

IEC/IEEE-bus : SOUR:WCDM:MULT:MAST 1

MULTICODE OF CHANNELS

Selection of the channels for multicode transmission. The selected channels are marked with an X.

IEC/IEEE-bus : SOUR:WCDM:MULT:CHAN #H1E

SEQUENCE LENGTH [FRAMES]

Defines the length of the calculated chip sequence in number of frames.

IEC/IEEE-bus command : SOUR:WCDM:SLEN 4

CHNO

Column title for the display of the number of the channel for which the settings of the corresponding line are valid. The other columns can be selected with "=>" and "<=".

TYPE Opens a window for selecting the channel type.

PERCH Perch 1-channel with Pilot, DATA and LMS data field. Selection is possible with LINK DIRECTION - DOWN.

CCPCH Common Control Physical Channel with Pilot and DATA field. Selection is possible with LINK DIRECTION - DOWN and UP.

DPCH Dedicated Control Physical Channel with Pilot, TPC and DATA field. Selection is possible with LINK DIRECTION - DOWN and UP.

ALLD All data channel type only with DATA field. Selection is possible with LINK DIRECTION - DOWN and UP.

IEC/IEEE-bus command : SOUR : WCDM : CHAN4 : DPCH

SYMBOL RATE Opens a window for selecting the symbol rate. The admissible selection depends on the channel type selected (TYPE). The possible values are represented in the following table:

TYPE	SYMBOL RATE kS/s
PERCH	16
CCPCH	64
DPCH	32, 64, 128, 256, 512, 1024
DPDCH	16, 32, 64, 128, 256, 512, 1024
DPCCH	16
ALLD	16, 32, 64, 128, 256, 512, 1024

IEC/IEEE-bus command : SOUR : WCDM : CHAN4 : SRAT D64

Menu selection: DIGITAL STD - WCDMA - SPREAD CODE

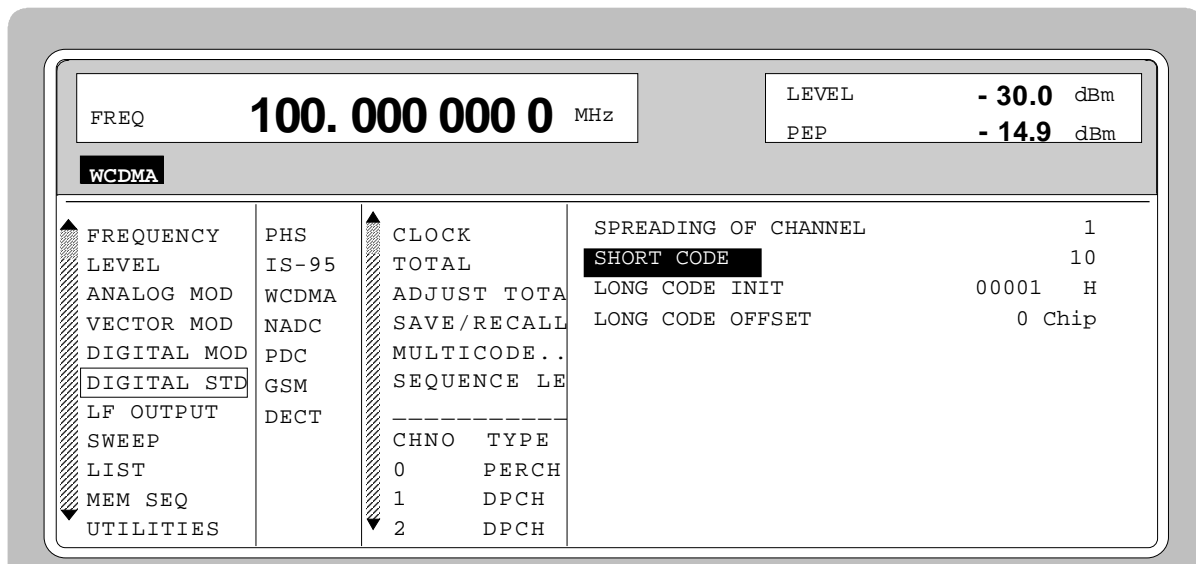

Fig. 2-94 Menu DIGITAL STD - WCDMA - SPREAD CODE; equipped with options modulation coder SMIQB20, data generator SMIQB11 and SMIQB43

SPREAD CODE Opens a window for the spread code settings. The first line of the window indicates the code channel for which the settings are done (SPREADING OF CHANNEL NO).

(SPREAD CODE)	SHORT CODE	Entry value for the short code index. The upper limit depends on parameters CHIP RATE, SYMBOL RATE as well as on the channel type. IEC/IEEE : SOUR:WCDM:CHAN4:SCOD 12
	LONG CODE INIT	Entry value for initializing the long code generator in hexadecimal notation. IEC/IEEE : SOUR: WCDM:CHAN4:LCOD #HFFF
	LONG CODE OFFSET	Entry value for a time shift of the long code with respect to the data symbols in units of chip duration. IEC/IEEE : SOUR:WCDM:CHAN4:LCOD:OFFS 1
	LMS SHORT CODE	Entry value for the short code index used for spreading the long code mask symbols (LMS) of the Perch channel. IEC/IEEE : SOUR:WCDM:CHAN4:SCOD:LMS #HFF

POWER

Input value for channel power.

POWER indicates the average power of the code channel relative to the power indicated in LEVEL display (code domain power).

For MODE - 4CHAN

- the power of channels 0, 1, 2 and 3 is set separately.

For MODE - 8CHAN

- the power of channel 0 is set separately.
- the other channels have the same power. The power for all the channels is set, for instant, in channel 1.

For MODE - 15CHAN

- Since all channels have the same power, they cannot be set. POWER is only a display parameter in this case.

When this value is modified, the value of TOTAL POWER is automatically adapted.

IEC/IEEE-bus command : SOUR:WCDM:CHAN4:POW -3

Menu selection: DIGITAL STD - WCDMA - DATA

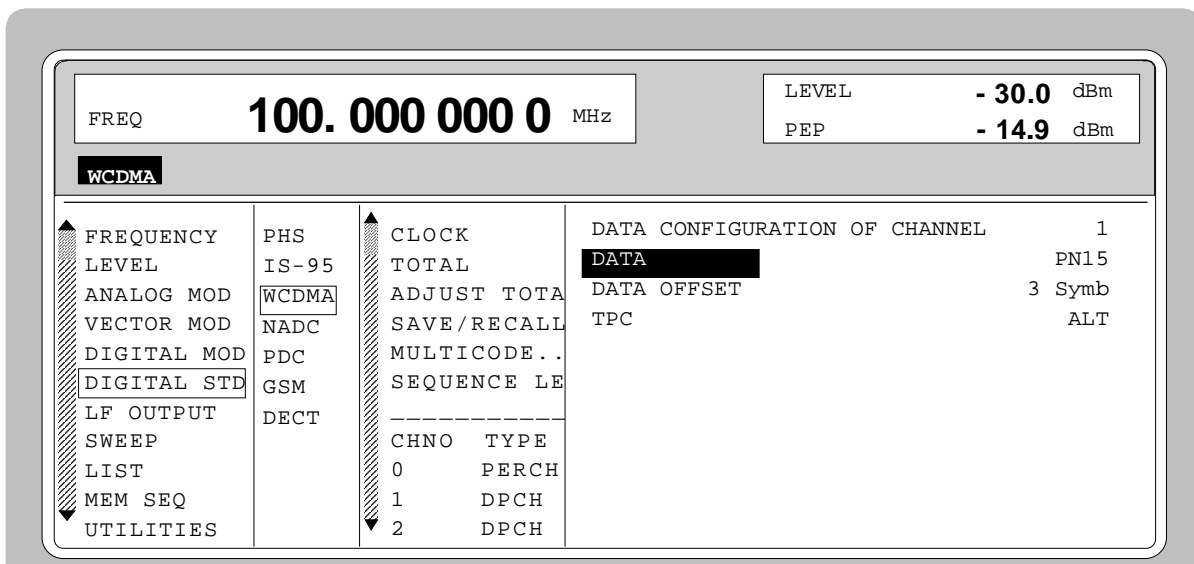

Fig. 2-95 Menu DIGITAL STD - WCDMA - DATA; equipped with options modulation coder SMIQB20, data generator SMIQB11 and SMIQB43

DATA... Opens a window for selecting data sources and setting a data offset. The first line of the window indicates the code channel for which the settings are done (DATA CONFIGURATION OF CHANNEL NO).

DATA Selection of the data source for the DATA field of the selected channel type. The data from the selected data source are permanently continued from slot to slot in the data field.

PN.. PRBS data to CCITT with period lengths between 29-1 and 216-1.

DLIST Data from a list previously programmed and stored. Programming is performed in the menu
DIGITAL MOD - SOURCE - EDIT DATA LIST

IEC/IEEE-bus : SOUR:WCDM:CHAN4:DATA PN9

DATA OFFSET Entry value for a data offset in units of symbol duration. The admissible range is as large as the length of a radio frame. The entry of a data offset shifts in time the modulation data with respect to the spread code.

IEC/IEEE-bus : SOUR:WCDM:CHAN4:DATA:OFFS 3

TPC Selection of the data source for the TPC field in channel types DPCH and DPCCh.

0 0 data are continuously generated

1 1 data are continuously generated

ALT The TPC field is alternately assigned with 1 or 0 from slot to slot.
(The first slot contains 1 data).

DLIST Data from a list previously programmed and stored. Programming is performed in the menu DIGITAL MOD - SOURCE - EDIT DATA LIST

IEC/IEEE-bus : SOUR:WCDM:CHAN4:TPC ZERO

STATE Switch on/off of assigned code channel.

IEC/IEEE-bus command : SOUR:WCDM:CHAN4:STAT ON

2.13.5 Menu W-CDMA Standard - Uplink Signals with IQ Multiplex

The settings for generating W-CDMA signals can be accessed via the menu DIGITAL STD - W-CDMA. The figure below shows the menu for generating the uplink signal with multiplex mode for the I and Q channel in the 8CHAN mode. The previous section shows the menu for generating the up and downlink signals without IQ multiplex as well as the parameters which are identical for all modes.

Selection: DIGITAL STD - WCDMA- MODE -8CHAN, -LINK DIRECTION/MULTIPLEX - UP_IQ_MULT

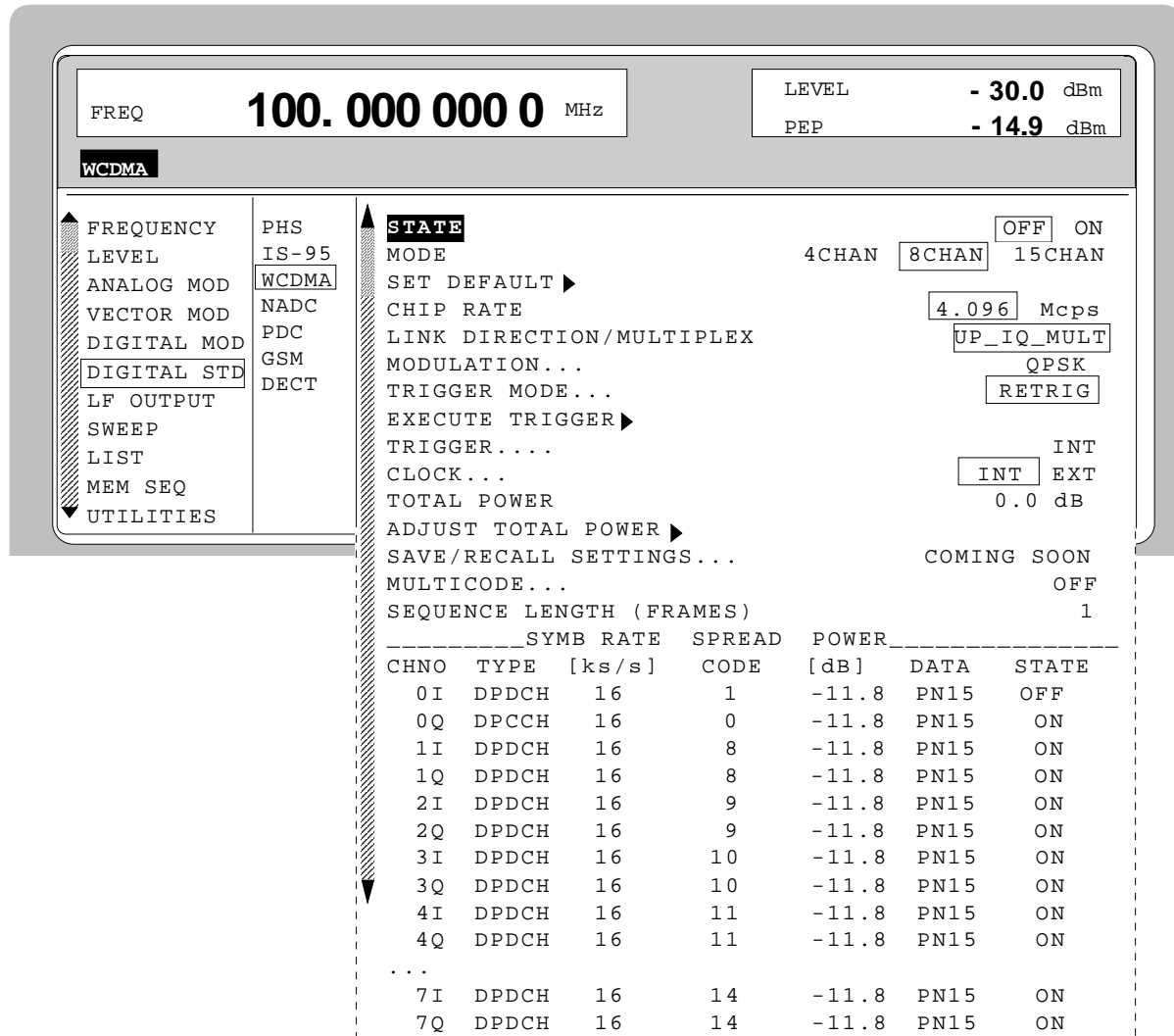

Fig. 2-96 Menu DIGITAL STD - WCDMA - MODE - 8CHAN, -LINK DIRECTION/MULTIPLEX - UP_IQ_MULT, equipped with options modulation coder SMIQB20, data generator SMIQB11 and SMIQB43

Parameters STATE to SEQUENCE LENGTH see section " Menu W-CDMA Standard -Downlink and Uplink Signals without IQ Multiplex"

CHNO	<p>Column title for the display of channel numbers.</p> <p>I Line for the parameters of the I channel</p> <p>Q Line for the parameters of the Q channel</p>
TYPE	<p>Opens a window for selecting the channel type. The channel type can be separately set for the I and Q channel.</p> <p>DPDCH Dedicated Physical Data Channel with data field DATA</p> <p>DPCCH Dedicated Physical Control Channel with data field Pilot and TPC</p> <p>IEC/IEEE-bus command : SOUR:WCDM:CHAN4:I:TYPE DPCC</p>
SYMBOL RATE	<p>Opens a window for selecting the symbol rate. The admissible selection depends on the channel type selected (TYPE). Possible values for DPDCH are 16, 32, 64, 128, 256, 512 and 1024 ksymbol/s (ksymbols per second). The DPDCH type has a fixed symbol rate of 16 ksymbol/s. The symbol rate can be separately set for the I and Q channel.</p> <p>IEC/IEEE-bus command : SOUR:WCDM:CHAN4:I:SRAT D16</p>
SPREAD CODE	<p>Opens a window for the spread code settings. The first line of the window indicates the code channel for which the settings are done (SPREADING OF CHANNEL NO).</p> <p>The long code settings are valid in common for the I and Q channel. For the short code of I and Q separate settings are possible within a channel number line.</p>
SHORT CODE	<p>Entry value for the short code index.</p> <p>The upper limit depends on parameters CHIP RATE, SYMBOL RATE.</p> <p>IEC/IEEE : SOUR:WCDM:CHAN4:I:SCOD 9</p>
LONG CODE INIT	<p>Entry value for initializing the long code generator in hexadecimal notation.</p> <p>IEC/IEEE : SOUR:WCDM:CHAN4:I:LCOD #H1</p>
LONG CODE OFFSET	<p>Entry value for a time shift of the long code with respect to the data symbols in units of chip duration.</p> <p>IEC/IEEE : SOUR:WCDM:CHAN4:I:LCOD:OFFS 5</p>

POWER

Input value for channel power

POWER indicates the average power of the I or Q code channel component in relation to the power indicated in the LEVEL display (Code Domain Power).

The setting values for the I and Q code channels having the same channel number should always be identical.

For MODE - 4CHAN

- the power of channels 0, 1, 2 and 3 is set separately.

For MODE - 8CHAN

- the power of channel 0 is set separately.
- the other channels have the same power. The power for all the channels is set, for instant, in channel 1.

For MODE - 15CHAN

- Since all channels have the same power, they cannot be set. POWER is only a display parameter in this case.

When this value is modified, the value of TOTAL POWER is automatically adapted if STATE = ON.

IEC/IEEE-bus command : SOUR:WCDM:CHAN4:I:POW -6

DATA...

Opens a window for selecting data sources and setting a data offset. The first line of the window indicates the code channel for which the settings are done (DATA CONFIGURATION OF CHANNEL NO).

The data source, the data offset and TPC can be separately set for the I and Q channel.

DATA

Selection of the data source for the DATA field of a DPDCH channel.

PN.. PRBS data to CCITT with period lengths between 2^9-1 and $2^{16}-1$.

DLIST Data from a list previously programmed and stored. Programming is performed in the menu DIGITAL MOD - SOURCE - EDIT DATA LIST

IEC/IEEE-bus : SOUR:WCDM:CHAN4:I:DATA PN15

DATA OFFSET

Entry value for a data offset in units of symbol duration. The admissible range is as large as the length of a radio frame. The entry of a data offset shifts in time the modulation data with respect to the spread code.

IEC/IEEE-bus : SOUR:WCDM:CHAN4:I:DATA:OFFS 2

(DATA...)	TPC	<p>Selection of the data source for the TPC field of a DPDCH channel.</p> <p>0 0 data are continuously generated</p> <p>1 1 data are continuously generated</p> <p>ALT The TPC field is alternately assigned with 1 or 0 from slot to slot. (The first slot contains 1 data).</p> <p>DLIST Data from a list previously programmed and stored. Programming is performed in the menu DIGITAL MOD - SOURCE - EDIT DATA LIST</p> <p>IEC/IEEE-bus : SOUR:WCDM:CHAN4:I:TPC ZERO</p>
------------------	------------	---

STATE Activation or deactivation of the I or Q component of the assigned code channel. The I or Q component of channels with common power-up should always have the same state ON or OFF.

IEC/IEEE-bus command : SOUR:WCDM:CHAN4:I:STAT ON

2.14 Digital Standard 3GPP W-CDMA (FDD)

The SIMQ can generate 3GPP W-CDMA signals provided that the SIMQ is equipped with the following options: Modulation Coder (SMIQB20), Data Generator (SMIQB11) and Digital Standard 3GPP W-CDMA (SMIQB45). Section 2.14.1 gives an overview of this mobile transmission method. Section 2.14.2 describes the associated operating functions. Section 2.14.3 provides in-depth information about the generation of 3GPP W-CDMA signals.

Chapter 2.15 describes all enhanced functions for digital standard 3GPP W-CDMA (option SIMQB48).

2.14.1 Description of Mobile Radio Transmission Method 3GPP W-CDMA

W-CDMA (wideband CDMA) designates a group of mobile radio transmission methods which differ in numerous details. The SIMQ provides a version developed by the 3 GPP standard organization ("3rd Generation Partnership Project").

This version can be regarded as an amalgamation of the IMT-2000 proposals by

- Association of Radio Industries and Businesses (ARIB)
- The European Telecommunications Standards Institute (ETSI)

and is thus also the successor of versions to 3GPP 2.0.0, 2.1.0, 3.1.1,3.2.0 and 3.4.0 implemented in former firmware versions.

The current version (SIMQ firmware version 5.70 or higher) supports W-CDMA according to 3GPP in version 4.1.0 (FDD mode). It is compatible with "Release 1999".

References:

- [1] 3GPP TS 25.211 Version 4.1.0 Physical channels and mapping of transport channels onto physical channels (FDD)
- [2] 3GPP TS 25.213 Version 4.1.0 Spreading and modulation (FDD)
- [3] 3GPP TS 25.141 Version 4.1.0 Base station conformance testing (FDD)

The SIMQ simulates W-CDMA 3GPP at the physical channel layer. The following description is therefore limited to this layer.

Table 2-18 Parameters of W-CDMA system

Chip rate	3.84 Mcps
Channel types	<p>Downlink :</p> <ul style="list-style-type: none"> • Primary Common Pilot Channel (P-CPICH) • Secondary Common Pilot Channel (S-CPICH) • Primary Sync Channel (P-SCH) • Secondary Sync Channel (S-SCH) • Primary Common Control Phys. Channel (P-CCPCH) • Secondary Common Control Phys. Channel (S-CCPCH) • Page Indication Channel (PICH) • Acquisition Indication Channel (AICH) • Access Preamble Acquisition Indication Channel (AP-AICH) • Phys. Downlink Shared Channel (PDSCH) • Dedicated Physical Control Channel (DL-DPCCH) • Dedicated Phys. Channel (DPCH) <p>Uplink :</p> <ul style="list-style-type: none"> • Phys. Random Access Channel (PRACH) • Phys. Common Packet Channel (PCPCH) • Dedicated Physical Control Channel (DPCCH) • Dedicated Physical Data Channel (DPDCH)
Symbol rates	7.5 ksps, 15 ksps, 30 ksps to 960 ksps depending on type of channel
Number of channels	<p>4 base stations in the downlink with up to 128 DPCHs and 11 special channels each</p> <p>4 mobile stations in the uplink either with PRACH or PCPCH or DPDCH and up to 6 DPDCHs.</p>
Frame structure	<p>Timeslot: 0.667 ms,</p> <p>Radio Frame: 15 timeslots = 10 ms, the structure of the frames depends on the symbol rate.</p>
Scrambling code	<p>Downlink: 18 bit M sequence</p> <p>Uplink: 25 bit M sequence in long mode and 8 bit M sequence in short mode</p>
Channelization code for DPCH, DPDCH and DPCCH	<p>“Orthogonal Variable Spreading Factor Code (OVSF)”</p> <p>Orthogonal matrix of <i>chip rate/symbol rate</i></p>

2.14.1.1 System Components

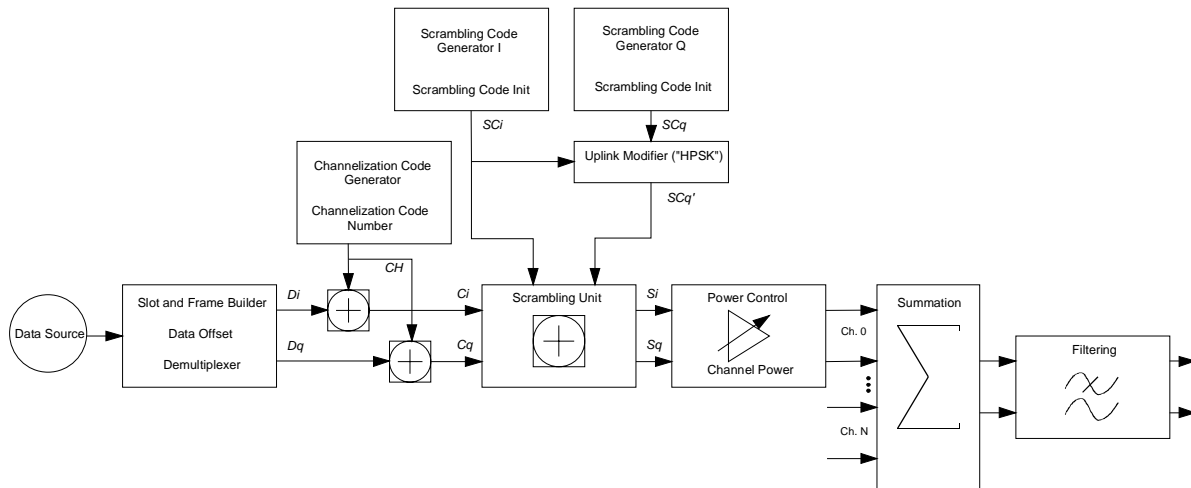

Fig. 2-97 Components of 3GPP W-CDMA transmission system

The individual functional blocks are described below in detail.

Scrambling code generator

The scrambling code generator (formerly long code generator) is used to scramble the chip sequence as a function of the transmitter. The structure and initialization rule of the generator differ depending on the link direction and the mode (long or short).

1. Downlink scrambling code generator

This generator consists of a pair of shift registers from which the binary sequences for in-phase and quadrature components of the scrambling code are determined. Fig. 2-98 shows that the I component results from an EXOR link of the LSB outputs whereas for the Q component the register contents are first output masked and then EXORed.

Note: *As an alternative, the Q component can be determined via a second pair of registers with the same structure, which idle for a certain number of cycles before the scrambling code bits are output. This I/Q offset is 131.072 in the downlink and 16.777.232 in the similarly designed uplink long scrambling code generator. For reasons of simplicity, the implementation shown in Fig. 2-98 is the better choice.*

Generator polynomials of downlink scrambling code generators

Shift register 1	$x^{18}+x^7+1$
Shift register 2	$x^{18}+x^{10}+x^7+x^5+1$

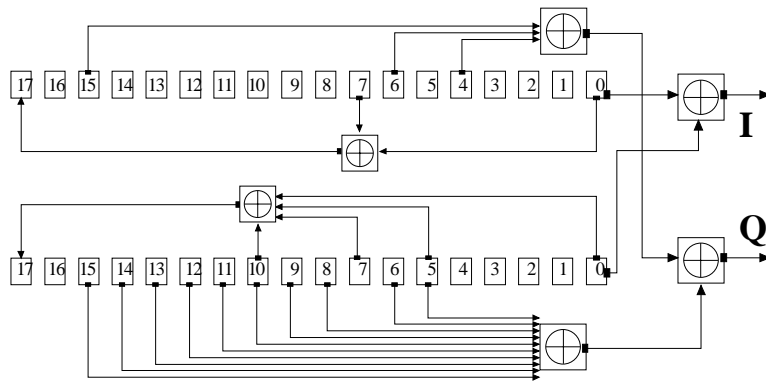

Fig. 2-98 Structure of the downlink scrambling code generator

The shift registers are initialized by loading shift register 1 with "0 to 01" and shift register 2 with all "1". In addition, shift register 1 is run forward by n cycles, n being the scrambling code number or in short the "scrambling code" (SC).

After a cycle time of one radio frame the generators are reset, i.e. the above initialization is carried out again.

2. Uplink scrambling code generator

In the uplink, distinction is made between two modes of the SC. There is on the one hand the long SC which can be used for all types of channel. On the other hand, there is the short SC which can be used for all channels except PRACH and PCPCH as an alternative to the long SC.

a) Uplink long scrambling code generator

The code generator of the long SC in the uplink has basically the same structure as the SC in the downlink. However, the generator polynomials of the shift registers and the type of initialization differ.

Table 2-19 Generator polynomials of uplink long scrambling code generators

Shift register 1	$x^{25}+x^3+1$
Shift register 2	$x^{25}+x^3+x^2+x+1$

The shift registers are initialized by assigning 1 to bit number 24 in shift register 1 and the binary form of the scrambling code number n to bits 23 to 0. Shift register 2 is loaded with all "1".

The readout positions for the Q component are such that they correspond to an IQ offset of 16.777.232 cycles.

After a cycle time of one radio frame the generators are reset, i.e. the above initialization is carried out again.

b) Uplink short scrambling code generator

The code generator of the short SC in the uplink comprises altogether 3 coupled shift registers.

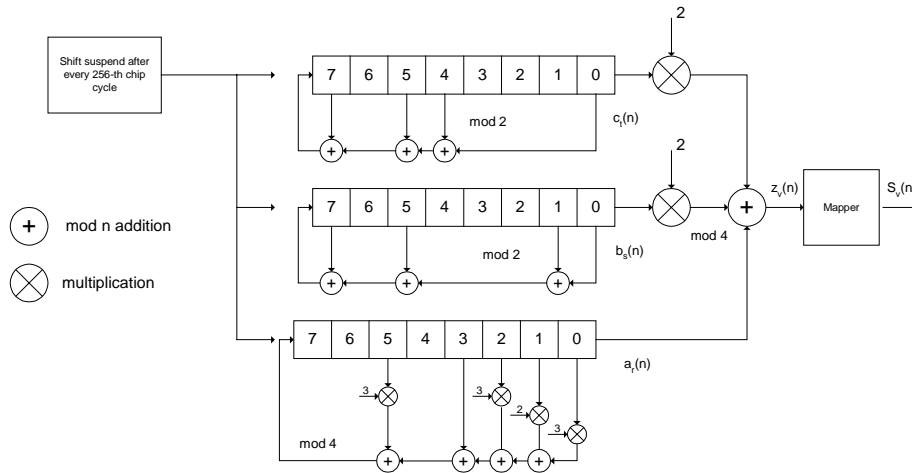

Fig. 2-99 Structure of the uplink short scrambling code generator

Table 2-20 Generator polynomials of uplink short scrambling code generators

Shift register 1 (binary)	$x^8+x^7+x^5+x^4+1$
Shift register 2 (binary)	$x^8+x^7+x^5+x+1$
Shift register 3 (quaternary)	$x^8+x^5+3x^3+x^2+2x1$

The output sequences of the two binary shift registers are weighted with factor 2 and added to the output sequence of the quaternary shift register (Modulo 4 addition). The resulting quaternary output sequence is mapped into the binary complex level by the mapper block.

For initialization of the three 8-bit shift registers (in a modified way) the binary form of the 24-bit short SC number n is used, for details see section 4.3.2.3 in [2].

Table 2-21 Mapping of the quaternary output sequence into the binary IQ level

$z_v(n)$	$S_v(n)$
0	$+1 + j1$
1	$-1 + j1$
2	$-1 - j1$
3	$+1 - j1$

c) Preamble scrambling code generator

When generating the preambles of the PRACH and PCPCH a special SC is used. It is based on the long SC described under a), however only the I component is taken and subsequently a pointer ($e^{j(P/4 + P/4 * k)}$, $k=0$ to 4095) modulated upon it.

Modification of the long and short scrambling code output sequence

The scrambling code sequence of the Q component is modified as standard to reduce the crest factor of the signal. Zero-crossings can then be avoided for every second chip using this method. (This method is often called HPSK).

For details see [2], section 4.3.2.1. The SMIQ uses a decimation factor of 2.

Scrambling Unit

In the scrambling unit, the output of the scrambling code generator and the spread symbols are combined. If the input signal and the scrambling code signal are interpreted as complex numbers ($C_i, C_q, SC_i, SC_q' \in \{-1, +1\}$), the output signal is a complex multiplication of the two signals:

$$S_i + j S_q = (C_i + j C_q) * (SC_i + j SC_q')$$

This gives:

$$\begin{aligned} S_i &= C_i SC_i - C_q SC_q' \\ S_q &= C_i SC_q' + C_q SC_i \end{aligned}$$

The signal obtained in this way has a constellation diagram like a QPSK signal:

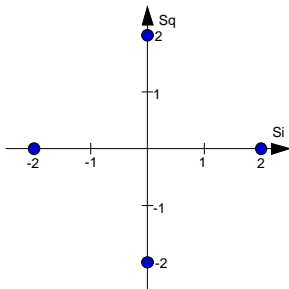

Fig. 2-100 Constellation diagram of a channel with 0 dB power

Note: *There are auxiliary conditions for some types of channels that may result in different constellation diagrams. If, for instance, symbols of SCH or preamble part of PRACH are coded, a BPSK constellation is obtained without the scrambling unit. For an explanation of the different constellation diagrams see section 2.14.3.*

Channelization code generator

The channelization code generator cyclically outputs a channel-specific bit pattern. The length of the cycle corresponds to the duration of the source symbol to be spread, i.e. the number of bits corresponds to the spread factor. The spreading sequence for the I and Q branches is identical (real). Spreading itself is a simple EXOR operation.

Two different channelization code generators are used depending on the type of channel:

Channelization code generator for all channels except SCH

Due to this channelization code the channel separation takes place in the sum signal. The channelization code number is the row in an orthogonal spreading matrix which is generated by an iterative process (OVSF).

Channelization code generator SCH

This generator replaces the one described above if the synchronization code symbol of the SCH channels is spread.

The spreading matrix is replaced by a method that forms the spreading sequence from a Hadamard sequence and a statistical sequence. For details see [2], section 5.2.3.1.

Data source

The data source used in the SMIQ is implemented at the physical layer. There is neither mapping of logical channels to physical channels nor is inner coding/outer coding performed. If the data source is to be implemented at a higher layer, this can be done with the aid of a file interface (see section 5.6 in the operating manual).

Slot and frame builder

The bits from the data source are first entered into a frame structure. The frames are made up of two hierarchical levels:

Table 2-22 Hierarchical structure of 3GPP W-CDMA frames

Hierarchy	Length in ms	Remarks
Time slot	0.667	
Radio frame	10	After a radio frame, pilot symbols are repeated. A radio frame consists of 15 time slots. This is also the length of a scrambling code cycle. Frames are the basic unit in the SMIQ. The sequence length is stated in radio frames.

The configuration of the time slots depends on the channel type and symbol rate. The following components are distinguished:

- Pilot sequence

The pilot sequence characterizes the time slot position within the radio frame and also depends on the symbol rate, transmit diversity and the pilot length parameter. Channel types DPCH, S-CCPCH, DL-DPCCH, DPCCH, PRACH and PCPCH have a pilot sequence. The pilot sequence cannot be changed by the user.
- Synchronization code symbol

The synchronization code symbol is the only symbol of the SCH. It is fixed to "11".
- TPC symbol

This symbol is used to control the transmit power. It is used in DPCH, DL-DPCCH and DPCCH. A bit pattern for the sequence of TPC symbols can be indicated as a channel-specific pattern.
- Data symbols

These symbols carry the user information and are fed from the data source. They are used in DPCH, P-CCPCH, S-CCPCH, PDSCH, DL-DPCCH, DPDCH, PRACH and PCPCH.
- Signature

The signature is used in PRACH and PCPCH. 16 fix bit patterns are defined of which the user may select one.
- TFCI

The "Transport Format Combination Indicator" is used in DPCH/DPCCH if the corresponding button of the interface (Base Station Configuration, see section 2.14.2.5/ Mobile Station Configuration, see section 2.14.2.6) is activated. In this case, a code sequence with the length of 30 is defined using this value and distributed among 15 subsequent time slots. In PRACH and PCPCH, the TFCI field is provided as standard.
- FBI

Feedback indication bits are only used in DPCCH and PCPCH.

Timing offset

The symbol stream can be shifted in time relative to the other channels. For this purpose a timing offset can be entered into the channel table, stating the range of shifting in multiples of 256 chips. Since the SMIQ does not generate infinite symbol streams like a realtime system, this offset is implemented as a rotation.

Example for DPCH 30 kbps, 1 time slot,

Timing offset = 2 → 2 x 256 chips = 512 chip offset → 4 data symbols shifting at a symbol rate of 30 kbps (1 symbol corresponds to 3.84 Mcps / 30 kbps = 128 chips).

previously:

11	11	11	11	00	01	10	11	00	10	01	11	11	01	00	01	10	11	01	00
----	----	----	----	----	----	----	----	----	----	----	----	----	----	----	----	----	----	----	----

afterwards:

10	11	01	00	11	11	11	11	00	01	10	11	00	10	01	11	11	01	00	01
----	----	----	----	----	----	----	----	----	----	----	----	----	----	----	----	----	----	----	----

The use of the timing offset usually causes a reduction of the crest factor of the total signal, since it is not always the same spreading chips (channelization chips) CH and scramble chips SC_i/SC_q' that are applied to the pilot sequences of the channels.

Demultiplexer

In the downlink, the symbol stream is divided into two bit streams D_i and D_q prior to processing in the spreading unit. The symbol stream is divided by allocating bits 1, 3, 5, to $2n-1$ to the in-phase bit stream D_i , and bits 2, 4, 6, $2n$ to the quadrature bit stream D_q .

For the above example with timing offset:

$$D_i = 11001111001101011000$$

$$D_q = 01101111010100111101$$

(lefthand bit is always the first one in the time sequence)

In the uplink, independent data are used for the two paths.

PRACH/PCPCH: Preamble: signature parallel to I and Q
 Message part : data to I, pilot and TFCI to Q

DPCCH: All bits to I, Q always unused

DPDCH: All bits are always to I or Q (dependent on channel number), the other path is unused.

Power control

After spreading and scrambling, a channel-specific power factor p is applied to the signal. A value of -6 dB therefore results in half the level (or $1/4$ power) and the following diagram (DPCH):

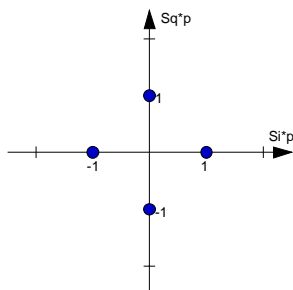

Fig. 2-101 Constellation diagram of a channel with -6 dB power

Summation

After application of the channel power, the components of the individual channels are summed up. The constellation diagram of the sum signal is obtained by superposition of the diagrams of the individual channels. If the signal consists of two channels with a power of -6 dB and -12 dB and each channel contains independent source data (DPCH), the following constellation diagram is obtained:

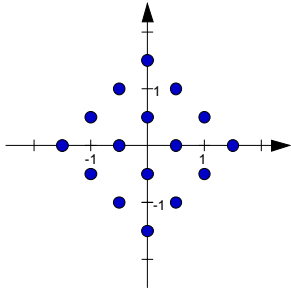

Fig. 2-102 Constellation diagram of a 3GPP W-CDMA signal with two DPCH channels

Filtering

An unfiltered spread signal is obtained after summation. Due to filtering the number of samples is increased by the oversampling factor and band-limiting is performed.

Multi code

3GPP W-CDMA supports multi-code transmission for downlink-dedicated physical channels (DPCH). This form of transmission is used for channels intended for the same receiver, i.e. those receivers that belong to a radio link. The first channel of this group is used as a master channel. Shared parts (pilot, TPC and TCFI) are spread for all channels using the spreading code of the master channel.

Note: *Instead of changing the spreading code within a slot several times, the master code rather than the shared parts can be sent at higher power. The other channels then have to be blanked out correspondingly.*

2.14.2 Generation of 3GPP W-CDMA Signals

The DIGITAL STD - WCDMA/3GPP menu is used to configure W-CDMA signals to the 3GPP standard (FDD). Up to 512 channels (distributed amongst up to four base or mobile stations) can be simulated in the downlink. The operation in the uplink was changed due to the extension to 3GPP version 3.1.1. In contrast to the 3GPP versions 2.0.0 and 2.1.0, there is no longer a large channel table with 128 DPDCHs. A mobile station has now 6 DPDCHs at maximum, the parameters of which are prescribed to a large extent by the standard. In order to obtain clear and simple operation, distinction is now made between 3 modes in the uplink (PRACH only, PCPCH only and DPCCH + DPDCH). In each mode, only the relevant parameters are displayed. But it is still possible to simulate a signal scenario of up to 4 mobile stations.

The menu is hierarchical with several levels. This organizes the large number of parameters in a clear way.

There are also other menus with parameters that modify the W-CDMA signal.

The following figure overviews all menus relevant for the W-CDMA signal and refers to related sections in the manual.

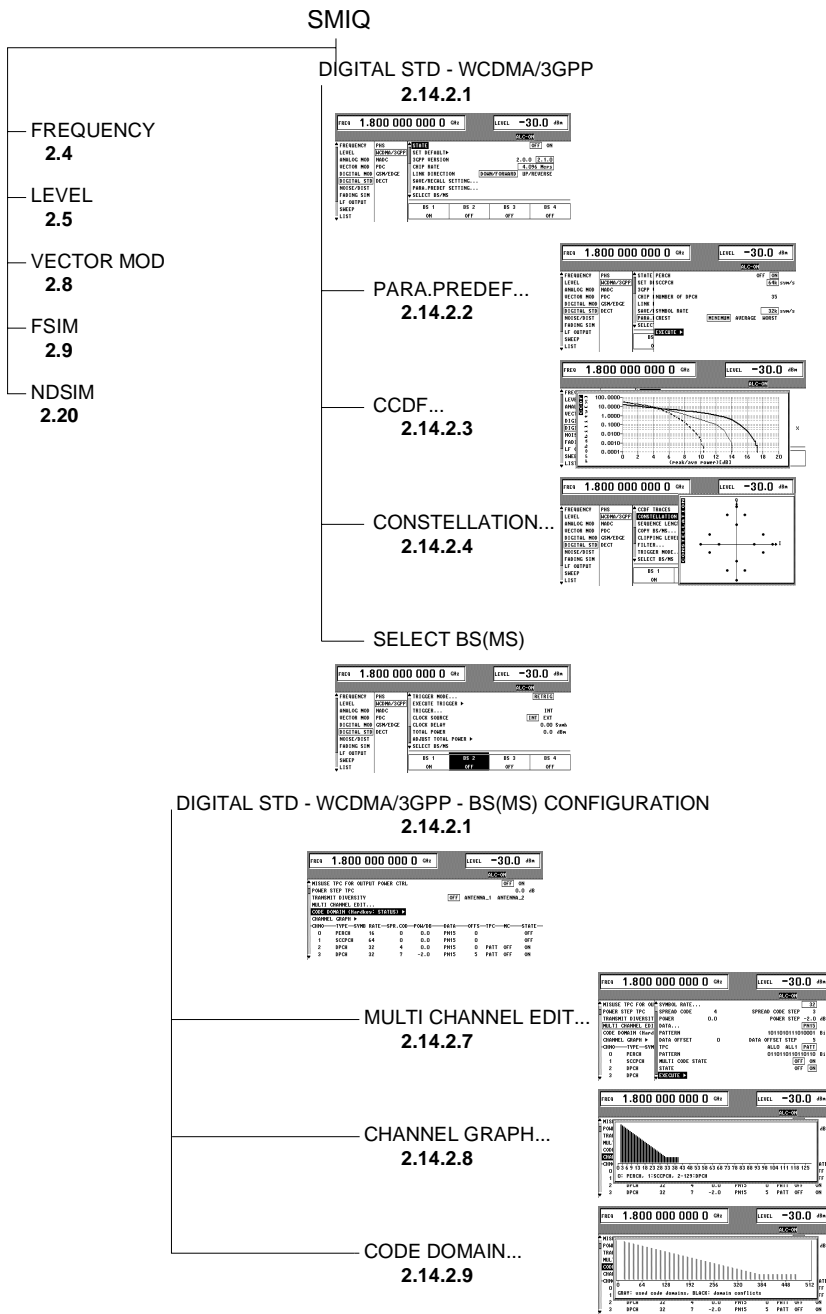

Fig. 2-103 Overview of DIGITAL STD – 3GPP WCDMA/3GPP menu structure

Note: The parts of the DIGITAL STD – WCDMA/3GPP menu that are below the SELECT BS(MS) function are not required if a signal is parameterized by means of the PARA. PREDFEF function (see section 2.14.2.2).

2.14.2.1 Menu WCDMA/3GPP

The following figure shows the menu for generating a downlink signal (transmit signal of base station).

FREQ 2.000 000 000 0 GHz		LEVEL -30.0 dBm	
		PEP -19.4 dBm	
WCDMA/3GPP		ALC-S&H	
ANALOG MOD	PHS	STATE	OFF ON
VECTOR MOD	IS95	SET DEFAULT▶	
DIGITAL MOD	WCDMA	SAVE/RECALL SETTING...	
DIGITAL STD	WCDMA/3GPP	TEST MODELS...	
ARB MOD	NADC	-----General Settings-----	
BERT	PDC	3GPP VERSION	3.2.0 (RELEASE 99)
LF OUTPUT	GSM/EDGE	CHIP RATE	3.84 Mcps
SWEEP	DECT	LINK DIRECTION	DOWN/FORWARD UP/REVERSE
LIST		SEQUENCE LENGTH	1 Frame
MEM SEQ		CLIPPING LEVEL	100 %
UTILITIES		FILTER...	WCDMA 0.22
		-----Assistant/Enhanced Functions-----	
		PARA.PREDEF SETTING...	
		ENHANCED CHANNELS BS1/MS1...	OFF
		OCNS CHANNELS...	
		-----Graphics-----	
		CCDF ▶	
		CCDF TRACES	3
		CONSTELLATION ▶	
		COPY BS/MS...	
		TRIGGER MODE...	RETRIG
		EXECUTE TRIGGER ▶	
		TRIGGER...	INT
		CLOCK SOURCE	INT EXT
		CLOCK DELAY	0.00 Symb
		TOTAL POWER	0.0 dB
		ADJUST TOTAL POWER ▶	
		SELECT BS/MS	
		BS 1	BS 2
		ON	OFF
		BS 3	BS 4
		OFF	OFF

Fig. 2-104 DIGITAL STD - WCDMA/3GPP - Downlink menu

For clarity, associated parameters are combined to subgroups by horizontal lines.

STATE

Switch-on/off of modulation - digital standard 3GPP W-CDMA. If vector modulation, digital modulation or another digital standard are on, they are automatically switched off.

STATE = ON starts the calculation of a chip sequence based on current settings. The length of the chip sequence, and so the duration of the calculation, is determined by the SEQUENCE LENGTH parameter.

IEC/IEEE-bus command : SOUR:W3GP:STAT ON

Note: When a parameter is changed, STATE is automatically switched to OFF to ensure that the set values and the output signal are consistent. After changing all the values, STATE can manually be set to ON. This is possible via menu parameter STATE and with the MOD ON/OFF key below the rollkey.

A progress bar is displayed while the chip sequence is calculated. The progress of the calculation can also be read via the remote control interfaces.

IEC/IEEE-bus command : SOUR:W3GP:CAL:PROG?

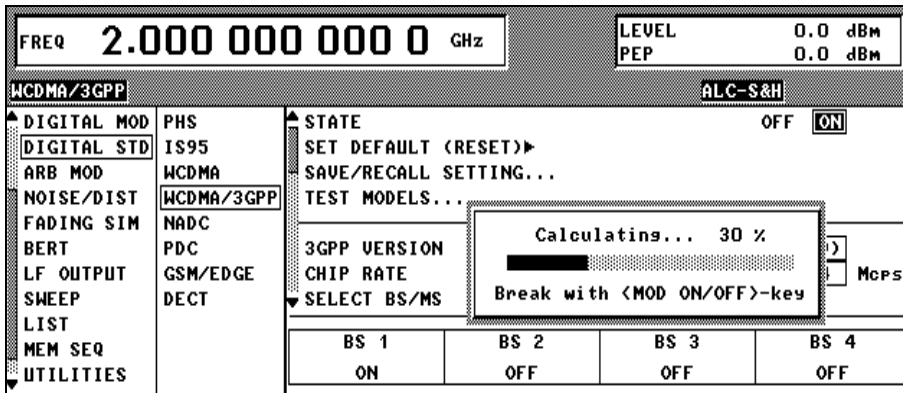

Fig. 2-105 DIGITAL STD - WCDMA/3GPP menu – progress bar

SET DEFAULT ▶

Sets the default setup for 3GPP W-CDMA.
 For further information about the default setting see section 2.14.2.12.
 IEC/IEEE-bus command :SOUR:W3GP:PRES

SAVE/RECALL...

The SMIQ supports two parallel SAVE/RECALL memory systems: The SAVE and RCL hardkeys are used to handle the frequency, level and state in the 3GPP W-CDMA menu. Menu selection SAVE/RECALL, however, manages all the other parameters in the 3GPP W-CDMA menu. This also includes station-specific parameters such as the channel table.

RECALL SETTING Recalling a saved configuration.
 IEC/IEEE bus :SOUR:W3GP:SETT:LOAD "MYSETUP"

SAVE SETTING Saving the current configuration.
 An existing setting can be overwritten or a new setting can be created. The name of the new setting is assigned automatically, e.g. WCDMASEQ1.
 If the setting is created via the IEC/IEEE bus, the name is user-selectable and the usual restrictions apply.
 IEC/IEEE bus :SOUR:W3GP:SETT:STOR "MYSETUP"

DELETE SETTING Deleting a configuration.
 IEC/IEEE bus :SOUR:W3GP:SETT:DEL "MYSETUP"

TEST MODELS

Selection of one of the test models defined in the 3GPP standard [3]. This menu item is available only in the downlink. The following test scenarios are available:

Test Model	Application/measurement
Test1_16 TEST MODEL 1 (16 channels)	Spectrum emission mask ACLR Spurious emissions Transmit intermodulation Modulation accuracy Peak code domain error
Test1_32 TEST MODEL 1 (32 channels)	Spectrum emission mask ACLR Spurious emissions Transmit intermodulation Modulation accuracy

Test1_64 TEST MODEL 1 (64 channels)	Spectrum emission mask ACLR Spurious emissions Transmit intermodulation Modulation accuracy
Test2 TEST MODEL 2	Output power dynamics
Test3_16 TEST MODEL 3 (16 channels)	Peak code domain error
Test3_32 TEST MODEL 3 (32 channels)	Peak code domain error

IEC/IEEE-bus command : SOUR:W3GP:SETT:TMOD "TEST1_16"

TEST MODELS (NOT STANDARDIZED)

No test models are defined for the uplink in the 3GPP standard. To be able to generate appropriate test signals by a keystroke nevertheless, the SMIQ offers predefined test signals also for the uplink.

Test model	Description
C+D60 k	Mobile station 1 is activated in the DPCCH + DPDCH mode. 60 ksps is selected as overall symbol rate and the power of DPCCH and DPDCH is set to 0 dB.
C+D960 k	Mobile station 1 is activated in the DPCCH + DPDCH mode. 960 ksps is selected as overall symbol rate and the power of DPCCH and DPDCH is set to 0 dB.

IEC/IEEE bus : SOUR:W3GP:SETT:TMOD "C+D60 k"

-----General Settings-----

- 3GPP VERSION** Display of current 3GPP version 3.2.0.
IEC/IEEE-bus command : SOUR:W3GP:GPP3:VERS?
- CHIP RATE** Display of fixed chip rate for a 3GPP W-CDMA of 3.84 Mcps.
IEC/IEEE-bus command : SOUR:W3GP:CRAT?
- LINK DIRECTION** Selecting the link direction:
DOWN/FORWARD Activates downlink-signal generation. In this mode, the base-station transmit signal can be generated.
IEC/IEEE-bus command : SOUR:W3GP:LINK FORW
UP/REVERSE Activates uplink-signal generation. In this mode, the mobile-station transmit signal can be generated.
IEC/IEEE-bus command : SOUR:WCDM:LINK REV
- SEQUENCE LENGTH (FRAMES)** The sequence length can be set.
The maximum length is 13 frames.
IEC/IEEE-bus command : SOUR:W3GP:SLEN 4
- CLIPPING LEVEL** Sets a clipping level relative to the highest peak in per cent. The value range is 1 to 100 %. A value of 100% means that the signal is not clipped. Clipping reduces the crest factor. For background information on how to use this parameter see section 2.14.2.10.
This menu item is only available with Option SMIQB48 installed. For details, see section 2.15.1.
IEC/IEEE-bus command : SOUR:W3GP:CLIPP:LEV 50

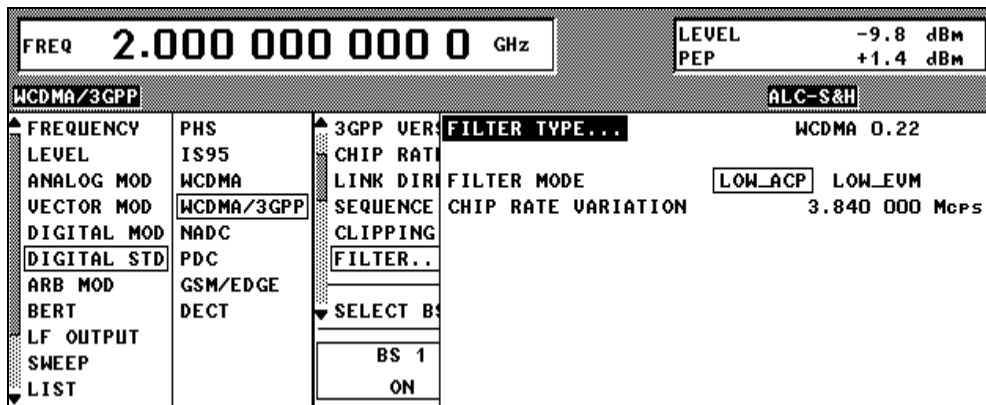

Fig. 2-106 DIGITAL STD - WCDMA/3GPP - FILTER... menu

- FILTER...** **FILTER** Selects the baseband filter. Either the W-CDMA standard filter WCDMA 0.22, the general Nyquist filters COS and SQRCOS or a user-defined filter USER (see section Digital Modulation) can be selected. The optimized square-root cosine filter WCDMA 0.22 is preset. Its roll-off factor is fixed at 0.22.
IEC/IEEE bus : SOUR:W3GP:FILT:TYPE WCDM

(FILTER...)	ROLL OFF FACTOR	<p>Setting value for the roll-off factor. The setting is only possible if a COS or SQRCOS filter is selected under FILTER.</p> <p>IEC/IEEE bus : SOUR:W3GP:FILT:PAR 0.22</p>
	FILTER MODE	<p>Selection of filter mode.</p> <p>LOW_ACP Filter for lowest adjacent-channel power. IEC bus : SOUR:W3GP:FILT:MODE LACP</p> <p>LOW_EVM Filter for lowest error vector magnitude. IEC bus : SOUR:W3GP:FILT:MODE LEVM</p>
	CHIP RATE VARIATION	<p>Input value of chip clock frequency. The value for CHIP RATE from the main menu is preset. CHIP RATE VARIATION changes the output clock, the modulation bandwidth and the output sync signals. It has no effect on the calculated chip sequence. The value range is 100 cps to 18 Mcps.</p> <p>IEC bus : SOUR:W3GP:CRAT:VAR 4096001</p>

-----Assistant/Enhanced Functions-----

PARA. PREDEF.	Calling parameterized predefined settings. This menu item is only available in the downlink. For a description of this function see section 2.14.2.2.
ENHANCED CHANNELS BS1/MS1	Calling an operating menu for the configuration of extended functions of the digital standard 3GPP W-CDMA. The menu item is available only if option SMIQB48 is installed. For more detail on this menu see section 2.15.1.
OCNS CHANNELS	Simulation of Orthogonal Channel Noise. The menu item can be accessed only in the downlink and is available provided option SMIQB48 is installed. For more detail on this menu see section 2.15.1.
ADDITIONAL MS BASED ON MS4	Simulation of up to 50 further mobile stations. The menu item can be accessed only in the uplink and is available provided option SMIQB48 is installed. For more detail on this menu see section 2.15.1.

-----Graphics-----

CCDF	A complementary cumulative distribution function is calculated and displayed using the signal in the waveform memory. For details see section 2.14.2.3.
CCDF TRACES	The number of simultaneously displayed CCDF traces can be set. For details see section 2.14.2.3.
CONSTELLATION	The constellation diagram for the signal in the waveform memory is calculated and displayed. For details see section 2.14.2.4.

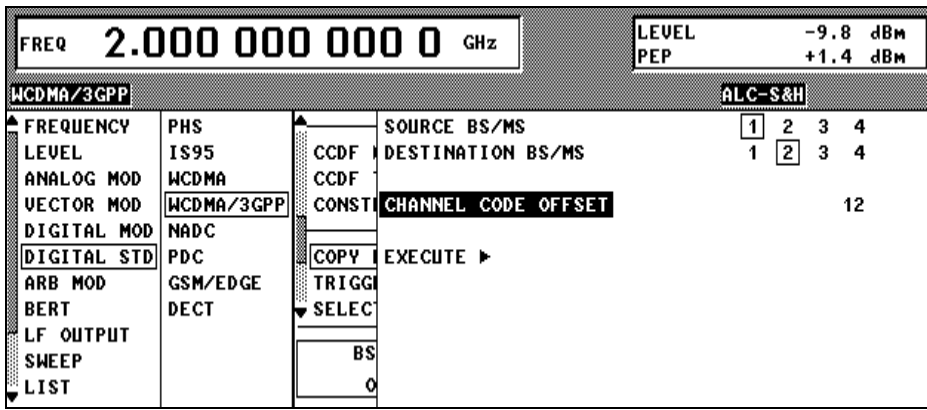

Fig. 2-107 DIGITAL STD - WCDMA/3GPP - Downlink - COPY BS(MS) menu

COPY BS(MS)...

Using COPY BS (MS) it is easy to create a new base/mobile station from an existing station. This feature is useful, say, when base stations with more than 128 data channels are to be simulated. For examples, see section 2.14.3.6.2.

SOURCE BS/MS

For selecting the BS(MS) whose parameter set is to be copied. Possible values are 1, 2, 3 or 4.

IEC/IEEE-bus command : SOUR : W3GP : COPY : SOUR 1

DESTINATION BS/MS

For selecting the destination BS(MS) whose parameter set is to be overwritten. Possible values are 1, 2, 3 or 4.

IEC/IEEE-bus command : SOUR : W3GP : COPY : DEST 2

CHANNELIZATION

CODE OFFSET

Offset used for the spreading codes during copying from the source BS to the channelization codes. The minimum value is 0 and the maximum value 511. This parameter is only available in the downlink.

IEC/IEEE-bus command : SOUR : W3GP : COPY : COFF 123

EXECUTE ►

Starts copying.

IEC/IEEE-bus command : SOUR : W3GP : COPY : EXEC

TRIGGER MODE

Configuration of W-CDMA sequence control (see section 2.14.2.11).

AUTO

The calculated W-CDMA chip sequence is immediately output and repeated cyclically. Trigger events are ignored.

IEC/IEEE-bus command : SOUR : W3GP : SEQ AUTO

RETRIG

The calculated W-CDMA chip sequence is immediately output and repeated cyclically. A trigger event causes a restart from frame 1.

IEC/IEEE-bus command : SOUR : W3GP : SEQ RETR

ARMED_AUTO

Only a trigger event results in the W-CDMA chip sequence being started from frame 1. Other trigger events are ignored.

IEC/IEEE-bus command : SOUR : W3GP : SEQ AAUT

ARMED_RETRIG

Only a trigger event results in the W-CDMA chip sequence being started from frame 1. Each further trigger event causes a restart.

IEC/IEEE-bus command : SOUR : W3GP : SEQ ARET

EXECUTE TRIGGER ► Executes a trigger event at the start of the W-CDMA chip sequence.
 IEC/IEEE-bus command : TRIG:DM:IMM

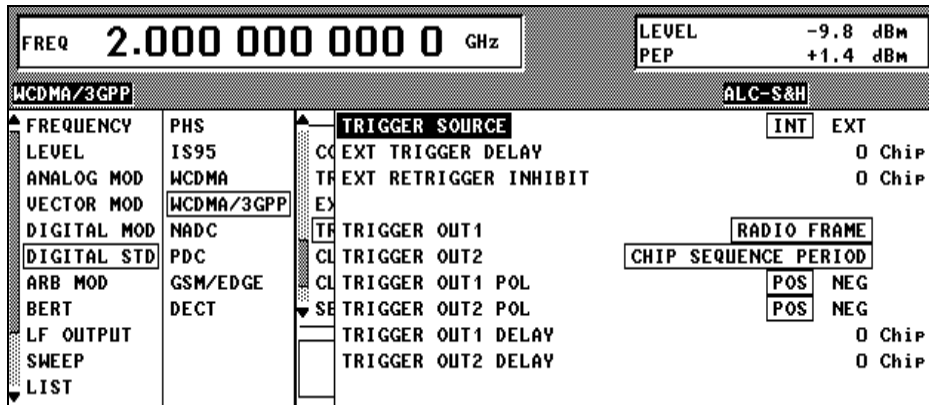

Fig. 2-108 DIGITAL STD – WCDMA/3GPP – TRIGGER... menu

TRIGGER... Opens a window to select the trigger source, to configure trigger output signals and to set the delay of an external trigger signal (see also section 2.14.2.11).

TRIGGER SOURCE For selecting the trigger source.

EXT The W-CDMA chip sequence is started from frame 1 on the active edge of an external trigger signal. The polarity, the trigger threshold and the input resistance of the TRIGIN input can be changed in the DIGITAL MOD - EXT INPUTS menu.

INT A trigger event is activated manually by EXECUTE TRIGGER.

IEC/IEEE-bus : SOUR:W3GP:TRIG:SOUR EXT

EXT TRIGGER DELAY For setting the number of chips by which an external trigger signal is delayed before it starts the W-CDMA chip sequence. This is used to set up synchronization with the DUT or other units.

IEC/IEEE-bus : SOUR:W3GP:TRIG:DEL 3

EXT RETRIGGER INHIBIT Sets the number of chips by which a restart is delayed after a trigger event. If the RETRIG TRIGGER MODE is selected, every further trigger signal restarts the W-CDMA chip sequence. This restart is inhibited for the number of chips that have been entered.

Example:
 The effect of entering 82000 chips is that any further trigger signal is ignored for 82000 chips after a trigger event.

IEC/IEEE-bus : SOUR:W3GP:TRIG:INH 82000

(TRIGGER...)	TRIGGER OUT 1/2	<p>For selecting signals for outputs TRIGOUT 1 and TRIGOUT 2 in the PARADATA connector. The times only apply if the internal clock generation frequency was not modified with the CHIP RATE VARIATION parameter.</p>
	SLOT	<p>0.667 ms slot clock IEC/IEEE-bus command: : SOUR:W3GP:TRIG:OUTP1 SLOT</p>
	RADIO FRAME	<p>10 ms frame clock IEC/IEEE-bus command: : SOUR:W3GP:TRIG:OUTP1 RFR</p>
	CHIP SEQUENCE PERIOD	<p>Marker signal for identifying the periodic repetition of the generated chip sequence IEC/IEEE-bus command: : SOUR:W3GP:TRIG:OUTP1 CSP</p>
	ENHANCED CHIP SEQUENCE PERIOD	<p>Marker signal for marking the periodic repetition of generated enhanced chip sequence (only displayed with option SMIQB48 installed). IEC/IEEE-bus command: : SOUR:W3GP:TRIG:OUTP1 ECSP</p>
	P-CCPCH /BCH SFN RESTART	<p>Marker signal for identifying the restart of the system frame number (SFN Restart) after 4096 frames (available only when option SMIQB48 is installed and a P-CCPCH/BCH is generated). IEC/IEEE-bus command: : SOUR:W3GP:TRIG:OUTP1 SFNR</p>
	TRIGGER OUT 1/2 POL	<p>Selects the polarity of signals at the TRIGOUT 1 and TRIGOUT 2 outputs in the PARADATA connector. IEC/IEEE-bus : SOUR:W3GP:OUTP2:POL POS</p>
	TRIGGER OUT 1/2 DELAY	<p>Setting of the number of chips by which the selected trigger output signal is delayed. IEC/IEEE-bus : SOUR:W3GP:OUTP2:DEL 0</p>

CLOCK SOURCE	<p>Allows selection of the clock source for the chip clock (see section 2.14.2.11).</p> <p>INT The SMIQ operates with internally generated clock signals.</p> <p>EXT A chip clock has to be fed in externally at the SYMBOL CLOCK connector. The CHIP RATE parameter must be set with an accuracy of $\pm 1\%$. The polarity, the trigger threshold and the input resistance of the SYMBOL CLOCK input can be changed in DIGITAL MOD - EXT INPUTS menu.</p> <p>IEC/IEEE-bus command : SOUR:W3GP:CLOC:SOUR INT</p>
EXT CLOCK MODE	<p>Selection of type of external chip signal.</p> <p>CHIP chip clock CHIPX4 Vierfacher Chiptakt</p> <p>ATTENTION: An external chip clock is fed in at connector SYMBOL CLOCK. Multi-folds chip clock has to be fed in at the connector BIT CLOCK!</p> <p>IEC/IEEE bus command : SOUR:W3GP:CLOCK:MODE CHIP4</p>
CLOCK DELAY	<p>Setting the delay of generated modulation signal to an external clock. This can be used, for example, for synchronization with a second unit to achieve time synchronicity between the modulation signals of the two units. The displayed setting resolution of 1/100 symbol is only attained for symbol-clock frequencies below 100 kHz. The resolution is reduced with increasing frequency. At a chip rate of 1.2288 Mcps, the resolution equals the chip duration $\times 0.1$.</p> <p>IEC/IEEE-bus command : SOUR:W3GP:CLOC:DEL 0.5</p>
TOTAL POWER	<p>Displays the total power of activated code channels. The total power is calculated from the power ratio of the activated code channels with the modulation switched on (STATE=ON). If the value is not equal to 0 dB, the individual code channels are internally adjusted (while maintaining the power ratios) so that the TOTAL POWER is 0 dB to obtain the output level (LEVEL) set in the header of the display. In addition to the average power, the peak envelope power (PEP) is also displayed.</p> <p>IEC/IEEE-bus command : SOUR:W3GP:POW?</p>

**ADJUST
TOTAL POWER ►**

Changes the power of every activated code channel so that the TOTAL POWER returns to 0 dB again, while the ratio of the powers of the individual code channels remains the same.

IEC/IEEE-bus command
: SOUR : W3GP : POW : ADJ

SELECT BS/MS

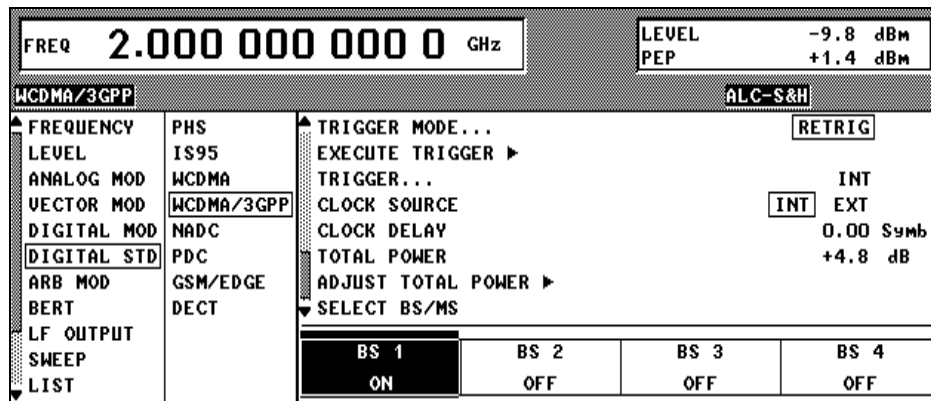

Fig. 2-109 DIGITAL STD – WCDMA/3GPP – SELECT BS(MS) menu

SELECT BS/MS has a special significance in the 3GPP W-CDMA menu: It is always displayed in the bottom line of the scrollable area, i.e. above the four station blocks. After selection of this menu item (**SELECT** hardkey), the cursor is positioned in the area below. The station whose parameters are to be edited can be selected by means of the spinwheel or the arrow keys.

Note: The state of the BS/MS can also be toggled without selecting the station. Just move the cursor to the station and press the ENTER key.

For editing the station parameters see section 2.14.2.5.

2.14.2.2 WCDMA/3GPP Menu - Para. Predef. Submenu

With the Para. Predef. function, it is possible to create highly complex scenarios with just a few keystrokes. This function is of use if, say, just the envelope of the signal is of interest. The menu is only available in the downlink.

FREQ 2.000 000 000 0 GHz		LEVEL -9.8 dBm	
		PEP +1.4 dBm	
WCDMA/3GPP		ALC-S&H	
FREQUENCY	PHS	CLIPP	CHANNELS FOR SYNC OF MOBILE
LEVEL	IS95	FILTE	S-CCPCH
ANALOG MOD	WCDMA		NUMBER OF DPCH
VECTOR MOD	WCDMA/3GPP	PARA.	SYMBOL RATE
DIGITAL MOD	NADC	ENHAN	CREST
DIGITAL STD	PDC	OCNS	EXECUTE ▶
ARB MOD	GSM/EDGE	SELEC	
BERT	DECT		
LF OUTPUT			
SWEEP			
LIST			

Fig. 2-110 DIGITAL STD - WCDMA/3GPP - PARA. PREDEF. menu (downlink only)

CHANNELS FOR SYNC OF MOBILE

When this parameter is set to ON, all "special channels" required by a mobile for synchronization are automatically activated. These are the following channels: P-CPICH, P-SCH, S-SCH, PCCPCH.

IEC/IEEE-bus command : SOUR:W3GP:PPAR:SCH OFF

SCCPCH

OFF

SCCPCH is not used in the scenario.

IEC/IEEE-bus command

: SOUR:W3GP:PPAR:SCCPC:STAT OFF

15k, 30k, to 960k

SCCPCH is used in the scenario at the stated symbol rate.

IEC/IEEE-bus commands

: SOUR:W3GP:PPAR:SCCPC:STAT ON

: SOUR:W3GP:PPAR:SCCPC:SRAT D15K

NUMBER OF DPCH

Number of DPCH in the scenario. The minimum number is 0. The maximum number is the ratio of the chip rate and the symbol rate (maximum 512 at the lowest symbol rate of 7.5 ksp/s).

IEC/IEEE-bus command : SOUR:W3GP:PPAR:DPCH:COUN 123

SYMBOL RATE

Symbol rate of all DPCH.

Possible values are 7,5k, 15k, 30k, 60k, 120k, 240k, 480k and 960k.

IEC/IEEE-bus command : SOUR:W3GP:PPAR:DPCH:SRAT D30K

CREST

The crest factor of the signal can be modified by setting appropriate channelization codes and timing offsets.

MINIMUM: The crest factor is minimized (the channelization codes are distributed uniformly over the code domain. The timing offsets are increased by 3 per channel).

IEC/IEEE-bus command : SOUR:W3GP:PPAR:CRES MIN

AVERAGE: An average crest factor is set (the channelization codes are distributed uniformly over the code domain. The timing offsets are all set to 0).

IEC/IEEE-bus command : SOUR:W3GP:PPAR:CRES AVER

WORST: The crest factor is set to an unfavourable value (i.e. maximum) (the channelization codes are assigned in ascending order. The timing offsets are all set to 0.)

IEC/IEEE-bus command : SOUR:W3GP:PPAR:CRES WORS

EXECUTE ►

The channel table is automatically filled up with the set parameters.
Scrambling Code 0 is automatically selected (as defined in the 3GPP test models).

IEC/IEEE-bus command : SOUR:W3GP:PPAR:EXEC

2.14.2.3 WCDMA/3GPP Menu - Display of CCDF

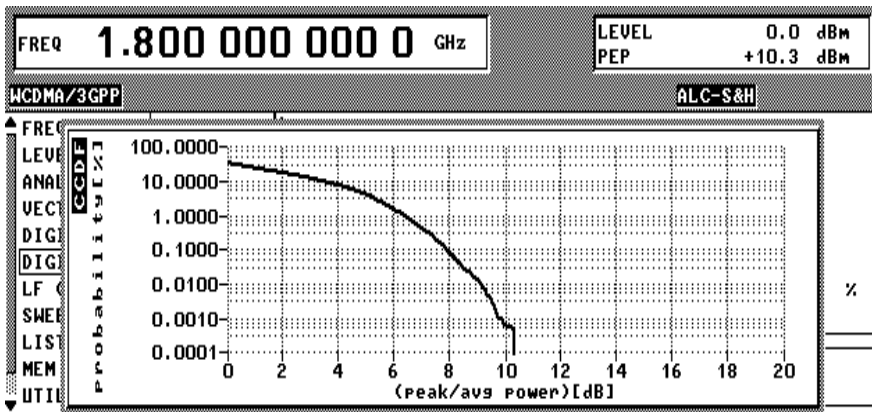

Fig. 2-111 DIGITAL STD – WCDMA/3GPP – CCDF menu with a trace

A complementary cumulative distribution function" can be generated from the filtered I/Q samples. This function gives the probability of the magnitude of a complex sample exceeding a predefined threshold. The complete waveform, i.e. the sum for all (max. 4) stations is used to calculate the CCDF.

If this threshold is thought of as the radius of a circle centered on the origin, the radius is plotted along the horizontal axis and the probability of the samples lying outside this circle along the vertical axis. Only radii that correspond to values that are at least as great as the average power are considered.

The crest factor can be read off at the intersection of the trace with the x axis. The precise value is obtained from the displayed levels (PEP-LEVEL).

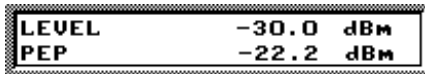

Fig. 2-112 Reading off the crest factor from LEVEL displays

In this example, the crest factor is 7.8 dB.

The number of simultaneously displayed traces can be set with the menu item NUMBER OF CCDF TRACES. Displaying several traces shows the effect of the parameters on the envelope. The baseband filter, the timing offsets and the channelization codes in particular have an effect on the CCDF.

The last three traces are distinguished in the following way:

Current trace: _____

Last trace: _____

Last but one trace: - - - - -

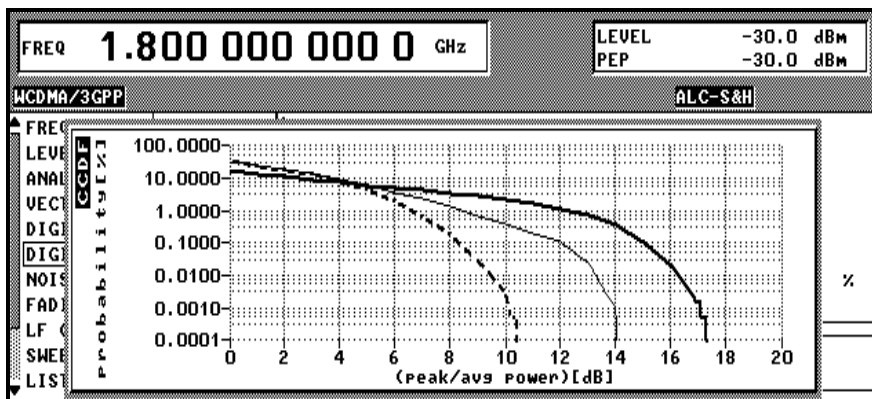

Fig. 2-113 DIGITAL STD – WCDMA/3GPP – CCDF menu with three traces

2.14.2.4 WCDMA/3GPP Menu – Displaying Constellation Diagrams

A constellation diagram can be calculated and displayed from the unfiltered I/Q samples (menu item CONSTELLATION).

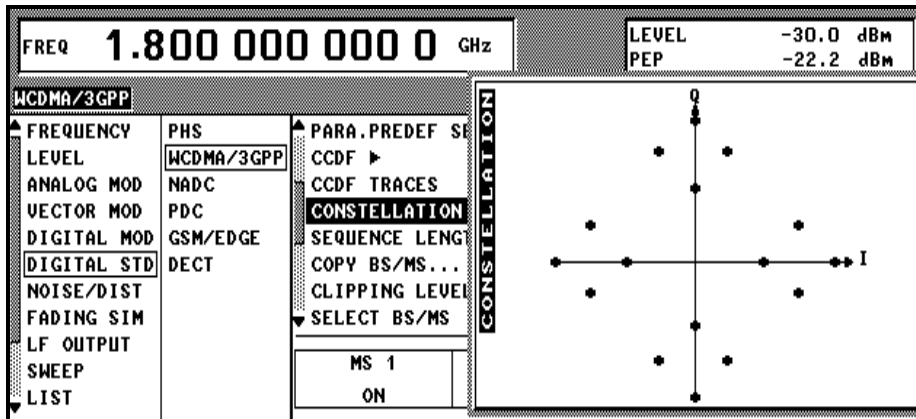

Fig. 2-114 DIGITAL STD - WCDMA/3GPP – CONSTELLATION menu

In addition to the code domain display (see section 2.14.2.9) and the CCDF display (see section 2.14.2.3) the constellation diagram is the most important display for a W-CDMA signal. In addition to channel powers, the effect of data sources etc and also the spreading scheme can be read off as a function of the type of channel. For further information on W-CDMA constellation diagrams see sections 2.14.3.1 and 2.14.3.3. The complete waveform, i.e. the sum for all (max. 4) stations is used to calculate the constellation diagram.

2.14.2.5 WCDMA/3GPP Menu - BS Configuration Submenu

The channel configuration for each base station is performed in this window. In the upper part of the window, the parameters valid for the whole BS are set and the channel-specific parameters are set in the bottom part of the table.

Note: To simplify handling of the large tables, state parameters like channel state or multi-code state can be toggled (ON/OFF) with the ENTER key.
The ENTER key can also be used to switch from 1 value to the next when 1 of n values can be selected (e.g. symbol rate).

FREQ		2.000 000 000 0 GHz				LEVEL		0.0 dBm		
ALC-ON										
CHNO	TYPE	SYM.RATE	CH.COD	POW/DB	DATA	TOFFS	PILOT	TPC	MC	STATE
11	DPCH	15	0	0.0	PN15	0	4	PATT	OFF	OFF
12	DPCH	15	0	0.0	PN15	0	4	PATT	OFF	OFF
13	DPCH	0	0	0.0	PN9	0	4	PATT	OFF	OFF
14	DPCH	0	0	0.0	PN15	0	4	PATT	OFF	OFF
15	DL-DPCCH	7.5	0	0.0	PN15	0	4	PATT	OFF	OFF
16	DPCH	15	0	0.0	PN15	0	4	PATT	OFF	OFF
17	DPCH	30	0	0.0	PN15	0	4	PATT	OFF	OFF
18	DPCH	15	0	0.0	PN15	0	4	PATT	OFF	OFF
19	DPCH	15	0	0.0	PN15	0	4	PATT	OFF	OFF
20	DPCH	15	0	0.0	PN15	0	4	PATT	OFF	OFF

Fig. 2-115 DIGITAL STD - WCDMA/3GPP menu – extended function of ENTER key

FREQ		2.000 000 000 0 GHz				LEVEL		-29.9 dBm		
						PEP		-19.3 dBm		
ALC-S&H										
WCDMA/3GPP										
BS 1										
SCRAMBLING CODE STATE										
SCRAMBLING CODE										
TFCI STATE										
TFCI										
2ND SEARCH CODE GROUP										
TPC PATTERN/DLIST READ OUT MODE										
MISUSE TPC FOR OUTPUT POWER CTRL										
POWER STEP TPC										
TRANSMIT DIVERSITY										
NUMBER OF PAGE INDICATORS PER FRAME										
MULTI CHANNEL EDIT...										
ENHANCED CHANNELS...										
CODE DOMAIN (Handkey: STATUS) ▶										
CHNO	TYPE	SYM.RATE	CH.COD	POW/DB	DATA	TOFFS	PILOT	TPC	MC	STATE
CHANNEL GRAPH ▶										
0	P-CPICH	15	0	-10.8						ON
1	S-CPICH	15	0	0.0						OFF
2	P-SCH	15		-10.8						ON
3	S-SCH	15		-10.8						ON
4	P-CCPCH	15	1	-10.8	PN15					ON
5	S-CCPCH	15	0	0.0	PN15					OFF
6	PICH	15	16	-15.8	PN15					ON
7	AP-AICH	15	0	0.0				PATT		OFF
8	AICH	15	0	0.0				PATT		OFF
9	PDSCH	15	0	0.0	PN15					OFF
10	DL-DPCCH	7.5	0	0.0				PATT		OFF
11	DPCH	30	2	-10.8	PN15	86	8	PATT	OFF	ON
12	DPCH	30	11	-12.8	PN15	134	8	PATT	OFF	ON
13	DPCH	30	17	-12.8	PN15	52	8	PATT	OFF	ON
14	DPCH	30	23	-14.8	PN15	45	8	PATT	OFF	ON
15	DPCH	30	31	-11.8	PN15	143	8	PATT	OFF	ON

Fig. 2-116 DIGITAL STD - WCDMA/3GPP - BS CONFIGURATION menu

Parameters that are valid for the current base station:

BS 1(2,3,4) STATE	ON	The BS is active. All other parameters are activated. IEC/IEEE-bus command : SOUR:W3GP:BST1:STAT ON
	OFF	The BS is inactive. The other parameters are ignored. IEC/IEEE-bus command : SOUR:W3GP:BST2:STAT OFF
SCRAMBLING CODE STATE	ON	The scrambling code is active. IEC/IEEE-bus : SOUR:W3GP:BST1:SCOD:STAT ON
	OFF	The scrambling code is inactive (test mode). IEC/IEEE-bus : SOUR:W3GP:BST2:SCOD:STAT OFF
SCRAMBLING CODE	Code of base station. At the same time, the initial value for the scrambling code generator. Permissible values are in the range 0 to 0x5FFF. IEC/IEEE-bus command : SOUR:W3GP:BST1:SCOD #H1	
TFCI STATE	ON	TFCI field is used in the frame. IEC/IEEE-bus command : SOUR:W3GP:BST1:TFCI:STAT ON
	OFF	TFCI field is not used in the frame. IEC/IEEE-bus command : SOUR:W3GP:BST2:TFCI:STAT OFF
TFCI (DPCH)	Setting the TFCI value in the range 0 to 1023. A combination of 30 bits is selected by this value. This combination is distributed over 15 successive slots in groups of two. IEC/IEEE-bus command : SOUR:W3GP:BST4:TFCI 21	
2ND SEARCH CODE GROUP	This parameter indexes the "Allocation of SSCs for secondary SCH" table described in the 3GPP standard, reference [2], Table 9. For each slot in the frame, this table assigns a certain spreading code to the synchronization code symbol. The parameter's range is 0 to 63. This parameter can only be read. The value is calculated from the SCRAMBLING CODE. IEC/IEEE-bus command : SOUR:W3GP:BST3:SSCG?	
TPC PATTERN READ OUT MODE	<p>TPC bits are used for W-CDMA to inform the called station if the transmit power is being increased or decreased. The contents of the TPC field can be separately defined in this panel in the table below for the channels of the BS. The parameter TPC Pattern Read Out Mode is used to define how this bit pattern is to be used. The following modes are distinguished:</p> <ul style="list-style-type: none"> • Continuous: A bit is taken for each slot from the up to 24-bit long bit pattern for the Transmitter Power Control field of the slots and entered in the bit stream several times (depending on the symbol rate). The specified bit pattern is used cyclically. • Single + All 0: A bit is taken for each slot from the up to 24-bit long bit pattern for the Transmitter Power Control field of the slots and entered in the bit stream several times (depending on the symbol rate). The specified bit pattern is used once, then the TPC sequence is continued with 0 bits. • Single + All 1: A bit is taken for each slot from the max. 24-bit long bit pattern for the Transmitter Power Control field of the slots and entered in the bit stream several times (depending on the symbol rate). The specified bit pattern is used once, then the TPC sequence is continued with 1 bits. 	

(TPC PATTERN READ OUT MODE)

- Single + alt. 01: A bit is taken for each slot from the up to 24-bit long bit pattern for the Transmitter Power Control field of the slots and entered the bit stream several times (depending on the symbol rate. The specified bit pattern is used once, then the TPC sequence is continued with 0 and 1 bits alternately (multiplied depending on the symbol rate, e.g. 00001111).
- Single + alt. 10: A bit is taken for each slot from the up to 24-bit long bit pattern for the Transmitter Power Control field of the slots and entered in the bit stream several times (depending on the symbol rate. The specified bit pattern is used once, then the TPC sequence is continued with 1 and 0 bits alternately (multiplied depending on the symbol rate, e.g. 11110000).

The different modes can be used for example to set a mobile to a specific output power (e.g. with pattern 11111) and then let it oscillate about this power (using Single + alt. 01 or Single + alt. 10). Thus power measurements on the mobile can be performed (with a quasi-constant power). In conjunction with the option (Mis-)Use TPC for output power control (see below) the TPC Read Out Mode can also be used for generation of various output power profiles.

IEC/IEEE-bus command : SOUR:W3GP:BST2:TPC:READ CONT

MISUSE TPC FOR OUTPUT POWER CONTROL

TPC bits are used for W-CDMA to inform the called station if the transmit power is being increased or decreased. If this option is activated, the given pattern is being misused to vary one's own transmit power over time. For each slot, one bit of this pattern is taken to increase (bit = 1) or decrease (bit = 0) the channel power by the stated power step (**POWER STEP TPC**). The upper limit is 0 dB and the lower -60 dB. The following envelope occurs at a channel power of 0 dB, a power step of 1.0 dB, the pattern "001110100000011" and TPC Pattern ReadOut Mode **Continuous**:

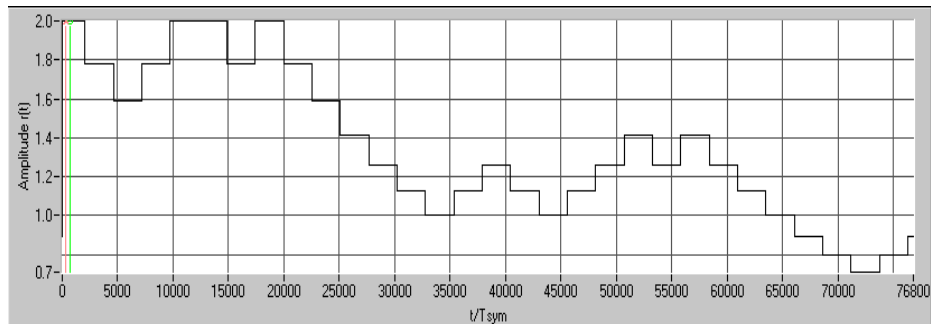

Fig. 2-117 Dynamic change of channel power (continuous)

Note: Observe that the power change (as specified in the standard) is always performed at the beginning of the slot pilot field.

IEC/IEEE-bus command : SOUR:W3GP:BST1:TPC:MIS ON

POWER STEP TPC

Size of power step in dB, if option **MISUSE TPC FOR OUTPUT POWER CONTROL** is activated. The value range is -10.0 dB to +10.0 dB.

IEC/IEEE-bus command : SOUR:W3GP:BST1:POW:STEP 1.0

TRANSMIT DIVERSITY	<p>The 3GPP standard describes various forms of transmit diversity. The signal is distributed with different coding between two antennas. The SMIQ can simulate the signal for one of the two antennas. A fixed diversity scheme is assigned to each channel type:</p> <p>DPCH, PCCPCH, SCCPH: STTD (Space time block coding transmit antenna diversity).</p> <p>Primary SCH, secondary SCH: TSTD (Time switched transmit diversity for SCH).</p> <p>Both schemes are described in detail in reference [1], section 5.3.1.</p> <p>If transmit diversity is required, the antenna whose signal is to be simulated can be specified.</p> <p>OFF: no transmit diversity</p> <p>ANTENNA 1: calculate antenna signal for antenna 1 and display result</p> <p>ANTENNA 2: calculate antenna signal for antenna 2 and display result</p> <p>IEC/IEEE-bus command : SOUR:W3GP:BST1:TRAN:DIV ANT1</p>
NUMBER OF PAGE INDICATORS PER FRAME	<p>The number of page indicators per frame in the page indication channel (PICH) can be defined thanks to this menu item. The value range is 18, 36, 72, 144.</p> <p>IEC/IEEE-bus command : SOUR:W3GP:BST2:PIND:COUNT D36</p>
MULTI CHANNEL EDIT...	<p>A certain number of DPCHs can be configured with just a few keystrokes using this menu item, see section 2.14.2.7.</p>
CHANNEL GRAPH	<p>This menu item gives an overview of the assigned channels, see section 2.14.2.8.</p>
CODE DOMAIN	<p>This menu item indicates the assignment of code domain, see section 2.14.2.9.</p>

Channel table:

FREQ		2.000 000 000 0 GHz				LEVEL		-29.4 dBm		
						PEP		-19.3 dBm		
WCDMA/3GPP					ALC-S&H					
CHNO	TYPE	SYM.RATE	CH.COD	POW/DB	DATA	TOFFS	PILOT	TPC	MC	STATE
0	P-CPICH	15	0	-10.8						ON
1	S-CPICH	15	0	0.0						OFF
2	P-SCH	15		-10.8						ON
3	S-SCH	15		-10.8						ON
4	P-CCPCH	15	1	-10.8	PN15					ON
5	S-CCPCH	15	0	0.0	PN15		0			OFF
6	PICH	15	16	-15.8	PN15					ON
7	AP-AICH	15	0	0.0				PATT		OFF
8	AICH	15	0	0.0				PATT		OFF
9	PDSCH	15	0	0.0	PN15					OFF
10	DL-DPCCH	7.5	0	0.0				PATT		OFF
11	DPCH	15	0	0.0	PN15	0	4	PATT	OFF	OFF
12	DPCH	15	0	0.0	PN15	0	4	PATT	OFF	OFF
13	DPCH	15	0	0.0	PN15	0	4	PATT	OFF	OFF
14	DPCH	15	0	0.0	PN15	0	4	PATT	OFF	OFF
15	DPCH	30	31	-11.8	PN15	143	8	PATT	OFF	ON
16	DPCH	30	38	-13.8	PN15	112	8	PATT	OFF	ON
17	DPCH	30	47	-17.8	PN15	59	8	PATT	OFF	ON
18	DPCH	30	55	-16.8	PN15	23	8	PATT	OFF	ON
19	DPCH	30	62	-13.8	PN15	1	8	PATT	OFF	ON

Fig. 2-118 DIGITAL STD – WCDMA/3GPP – BS CONFIGURATION / channel table menu

Below the general parameters of the current base station follows a table comprising all the parameters that can be edited on a channel-specific basis.

CH NO Channel number, consecutive from 0 to 138. This value cannot be edited. All rows are displayed even if the channels are inactive. Activating/deactivating is via STATE at the end of the row.

TYPE Channel type which is permanently linked to the channel number and which cannot be edited:
The first 11 code channels in the table are occupied for the special channels P-CPICH to DL-DPCCH. All other code channels are DPCHs. The channel type is a pure display parameter and cannot be edited. Not all parameters in the table can be edited. This depends on the type of channel.

SYMBOL RATE Symbol rate of channel in ksps.
The value range of symbol rate is modified depending on the channel type. For example, the P-CPICH is fixed at a symbol rate of 15 ksps by the 3GPP standard, but all symbol rates between 7.5 ksps and 960 ksps are available for a DPCH.

IEC/IEEE-bus command : SOUR:W3GP:BST3:CHAN12:SRAT D30K

CHANNELIZATION CODE The channelization code (previously called spreading code number) is selected here. The code channel is then spread with the channelization code (spreading code) thus determined. The value range of the channelization code depends on the symbol rate of the channel. A fixed channelization code is allocated to a few channels as standard (the P-CPICH e.g. always uses the channelization code 0).

The maximum value range extends from 0 to $\frac{chip_rate(=3.84Mcps)}{symbol_rate} - 1$

IEC/IEEE-bus command : SOUR:W3GP:BST3:CHAN12:CCOD 11

POWER [DB]	<p>Channel power in dB; range –60 to 0.0 dB.</p> <p>The stated power is relative to the powers of other channels and initially does not refer to the LEVEL power display. After activating ADJUST TOTAL POWER ► (top level of 3GPP W-CDMA menu) all power readings as referred to LEVEL.</p> <p>IEC/IEEE-bus command : SOUR:W3GP:BST3:CHAN3:POW -10.0</p>
DATA	<p>Selects the data source for the DATA field.</p> <p>Selection of PN9, PN11, PN15, PN16, ALL0, ALL1 and PATTern.</p> <p>The PN generator function is explained in section 2.12.3, for example.</p> <p>If the PATTern data type is used, the pattern can be modified with a special editor. The length is limited to 24 digits.</p> <p>IEC/IEEE-bus command : SOUR:W3GP:BST3:CHAN3:DATA PN15</p> <p>IEC/IEEE-bus command : SOUR:W3GP:BST3:CHAN3:DATA:PATT #H1234,15</p>
TIMING OFFSET	<p>A value greater than 0 causes the source symbols to be shifted prior to spreading. An offset of 1 for instance is recommended to obtain a low crest factor.</p> <p>The absolute starting time of the frames (slot 0) is shifted relative to the beginning of the scrambling code sequence by $T_{\text{Offset}} * 256$ chips. This means that the resolution of the timing offset is always 256 chips, irrespective of the symbol rate. The effect of the timing offset is explained in the following. The value range of the timing offset is from 0 to 149. The parameter is accessible for DPCHs only.</p> <p>IEC/IEEE-bus command : SOUR:W3GP:BST3:CHAN3:TOFF 5</p>
PILOT LENGTH	<p>Length of the pilot field in the slot structure of a channel. The value range of this parameter depends on the symbol rate. For DPCHs, the value range is 2 bits to max. 16 bits, for S_CCPCH 0, 8 and 16 bits. To achieve a constant length of the slot the data fields are lengthened or shortened depending on the pilot length as defined in the standard.</p> <p>IEC/IEEE-bus command : SOUR:W3GP:BST3:CHAN12:PLEN BIT2</p>
TPC	<p>Selects the data source for the TPC field.</p> <p>ALL0 All 0s are continuously entered in the TPC field. IEC/IEEE-bus command : SOUR:W3GP:BST1:CHAN2:TPC ZERO</p> <p>ALL1 All 1s are continuously entered in the TPC field. IEC/IEEE-bus command : SOUR:W3GP:BST2:CHAN129:TPC ONE</p> <p>PATT The TPC field is cyclically filled with a pattern that is up to 24 bits long. One bit is taken from this pattern per slot and, if necessary, reduplicated. A special pattern editor is displayed. IEC/IEEE-bus commands : SOUR:W3GP:BST2:CHAN24:TPC PATT : SOUR:W3GP:BST2:CHAN24:TPC:PATT #H3F, 8</p>
MC	<p>ON This channel is to be simulated with multicode. IEC/IEEE-bus command : SOUR:W3GP:BST1:CHAN2:MCOD ON</p> <p>OFF This channel is to be simulated without multicode. IEC/IEEE-bus command : SOUR:W3GP:BST2:CHAN99:MCOD OFF</p>
STATE	<p>ON The channel is activated. All parameters in this row are active. IEC/IEEE-bus command : SOUR:W3GP:BST1:CHAN1:STATE ON</p> <p>OFF The channel is not active. All parameters in this row are ignored. IEC/IEEE-bus command : SOUR:W3GP:BST2:CHAN9:STATE OFF</p>

2.14.2.6 WCDMA/3GPP Menu - MS Configuration Submenu

The channels for each mobile station are configured in this window. The operation in the uplink was changed due to the extension to 3GPP version 3.1.1. In contrast to the 3GPP versions 2.0.0 and 2.1.0, there is no longer a large channel table with 128 DPDCHs. A mobile station has now 6 DPDCHs at maximum, the parameters of which are prescribed to a large extent by the standard. In order to obtain clear and simple operation, distinction is now made between 3 modes in the uplink (PRACH only, PCPCH only and DPCCH + DPDCH). In each mode, only the relevant parameters are displayed.

FREQ 2.000 000 000 0 GHz		LEVEL -30.1 dBm
		PEP -22.9 dBm
WCDMA/3GPP		ALC-S&H
MS 1		OFF ON
MS MODE		DPCCH+DPDCH
SCRAMBLING CODE MODE		LONG
SCRAMBLING CODE		00 0000 H
TPC		PATT
TPC PATTERN	0	Bin
TPC PATTERN/DLIST READ OUT MODE		CONTINUOUS
DPCCH Settings		
POWER		0.0 dB
TIMING OFFSET		4
TFCI STATE		OFF ON

Fig. 2-119 DIGITAL STD – WCDMA/3GPP – MS CONFIGURATION menu

Parameters that are globally valid for current mobile station:

MS 1(2,3,4) STATE	ON	The MS is active. All other parameters are active. IEC/IEEE-bus command : SOUR:W3GP:MST1:STAT ON
	OFF	The MS is not active. The other parameters are ignored. IEC/IEEE-bus command : SOUR:W3GP:MST2:STAT OFF

MS MODE

Mode in which the mobile station is to operate. Depending on the mode, the lower part of the panel changes. Only the parameters relevant to the current mode are displayed. The following modes can be selected:

PRACH only In this mode, the MS generates a single Physical Random Access Channel (PRACH). This channel is required when a call is set up from the mobile to the base station. The specific parameters of the PRACH can be set according to the section **PRACH Settings** (see further down in this section).

IEC/IEEE-bus command:

: SOUR:W3GP:MST2:MODE PRACH

PCPCH only In this mode, the MS generates a single Physical Common Packet Channel (PCPCH). This channel is used for the transmission of packet-oriented services (e.g. SMS). The specific parameters of the PCPCH can then be set according to the section **PCPCH Settings** (see further down in this chapter).

IEC/IEEE-bus command:

: SOUR:W3GP:MST2:MODE PCPCH

DPCCH + DPDCH This is the standard mode of the mobile for speech and data transmission. The MS generates a control channel (DPCCH) and up to 6 data channels (DPDCH). The channel-specific parameters can then be set in the sections **DPCCH Settings** and **DPDCH Settings** (see further down in this section).

IEC/IEEE-bus command:

: SOUR:W3GP:MST2:MODE DPCDCH

- SCRAMBLING CODE MODE** A distinction is made between **Long** and **Short Scrambling Code**. The differences between the two codes can be found in section 2.14.1.1. The short SC can only be selected in the mode **DPCCH + DPDCH**. For PRACH and PCPCH, the long SC is always used.
IEC/IEEE-bus command : SOUR:W3GP:MST2:SCOD:MODE LONG
For test purposes, it is also possible to deactivate the scrambling code (**OFF**).
IEC/IEEE-bus command : SOUR:W3GP:MST2:SCOD:MODE OFF
- SCRAMBLING CODE** The scrambling code generator (previously called long code generator) is used to scramble the chip sequence depending on the transmitter. For more information of the structure of the generator and its initialization refer to section 2.14.1.1. The value range of the scrambling code is 0 to FF FFFF.
IEC/IEEE-bus command : SOUR:W3GP:MST1:SCOD #H1
- TPC** Selects the data source for the TPC field.
- ALL0** All 0s are continuously entered in the TPC field.
IEC/IEEE-bus command : SOUR:W3GP:BST1:CHAN2:TPC ZERO
- ALL1** All 1s are continuously entered in the TPC field.
IEC/IEEE-bus command : SOUR:W3GP:BST2:CHAN129:TPC ONE
- PATT** The TPC field is cyclically filled with a pattern that is up to 24 bits long. One bit is taken from this pattern per slot and, if necessary, reduplicated. A special pattern editor is displayed.
IEC/IEEE-bus commands
: SOUR:W3GP:MST1:TPC:DATA PATT
: SOUR:W3GP:BST2:CHAN24:TPC:PATT #H3F, 8
- DLIST** The TPC field is cyclically filled with a data list. Per slot, one bit is taken from the list and duplicated (only offered with option SMIQB48 installed and the DPCCH is calculated as an enhanced channel.)
IEC/IEEE-bus command
: SOUR:W3GP:MST1:TPC:DATA DLIS "mylist"

TPC PATTERN/DLIST READ OUT MODE TPC bits are used for W-CDMA to inform the called station if the transmit power is being increased or decreased. The parameter TPC Pattern Read Out Mode is used to define how this bit pattern is to be used. The following modes are distinguished:

- Continuous: A bit is taken for each slot from the up to 24-bit long bit pattern for the Transmitter Power Control field of the slots and entered in the bit stream several times (depending on the symbol rate). The specified bit pattern is used cyclically.
- Single + All 0: A bit is taken for each slot from the up to 24-bit long bit pattern for the Transmitter Power Control field of the slots and entered the bit stream several times (depending on the symbol rate). The specified bit pattern is used once, then the TPC sequence is continued with 0 bits.
- Single + All 1: A bit is taken for each slot from the max. 24-bit long bit pattern for the Transmitter Power Control field of the slots and entered in the bit stream several times (depending on the symbol rate). The specified bit pattern is used once, then the TPC sequence is continued with 1 bits.
- Single + alt. 01: A bit is taken for each slot from the up to 24-bit long bit pattern for the Transmitter Power Control field of the slots and entered the bit stream several times (depending on the symbol rate). The specified bit pattern is used once, then the TPC sequence is continued with 0 and 1 bits alternately (multiplied depending on the symbol rate, e.g. 00001111).
- Single + alt. 10: A bit is taken for each slot from the up to 24-bit long bit pattern for the Transmitter Power Control field of the slots and entered in the bit stream several times (depending on the symbol rate). The specified bit pattern is used once, then the TPC sequence is continued with 1 and 0 bits alternately (multiplied depending on the symbol rate, e.g. 11110000).

The different modes can be used for example to set a BS to a specific output power (e.g. with pattern 11111) and then let it oscillate about this power (using Single + alt. 01 or Single + alt. 10). Thus power measurements on a channel of the BS can be performed (with a quasi-constant power). In conjunction with the option (Mis-)Use TPC for output power control (see below) the TPC Read Out Mode can also be used for generation of various output power profiles.

If option SMIQB48 is installed and if a data list is used as TPC data source, the READ OUT MODE is also valid.

IEC/IEEE-bus command : SOUR:W3GP:MST2:TPC:READ CONT

Parameters in the PRACH only mode:

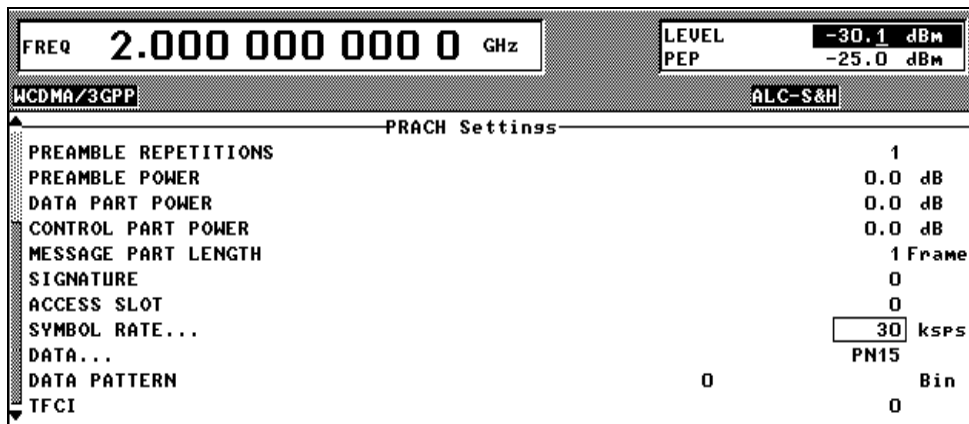

Fig. 2-120 DIGITAL STD – WCDMA/3GPP – MS CONFIGURATION: PRACH only Mode menu

PREAMBLE REPETITIONS	Number of repetitions of the preamble. Values between 1 and 10 can be selected. IEC/IEEE-bus command : SOUR:W3GP:MST2:PRAC:PREP 3
PREAMBLE POWER	Power of the components of the PRACH. The value range of the power is from -60 dB to 0 dB. IEC/IEEE-bus command : SOUR:W3GP:MST2:PRAC:PPOW -5
DATA PART POWER	Power of the data components of the PRACH. The value range of the power is from -60 dB to 0 dB. IEC/IEEE-bus command : SOUR:W3GP:MST2:PRAC:DPOW -3
CONTROL PART POWER	Power of the control components of the PRACH. The value range of the power is from -60 dB to 0 dB. IEC/IEEE-bus command : SOUR:W3GP:MST2:PRAC:CPOW -7
MESSAGE PART LENGTH	Length of message parts in Frames. Lengths 1 and 2 frames can be set. IEC/IEEE-bus command : SOUR:W3GP:MST2:PRAC:MLEN 2
SIGNATURE	This field permits to determine the signature to be used for the PRACH. Values between 0 and 15 are possible. IEC/IEEE-bus command : SOUR:W3GP:MST2:PRAC:SIGN 2
ACCESS SLOT#	Shifting of the starting time of the PRACH. The value range is 0 to 14. (Shifting of the starting time in time slots can be calculated as follows: 2 * Access Slot #). IEC/IEEE-bus command : SOUR:W3GP:MST2:PRAC:ASLO 2
SYMBOL RATE	Symbol rate of the PRACH. It is possible to select between 15 ksps, 30 ksps, 60 ksps and 120 ksps. IEC/IEEE-bus command : SOUR:W3GP:MST2:PRAC:SRAT D30k
DATA / DATA PATTERN	Selection of the data source for the DATA field. Selection from PN9, PN11, PN15, PN16, ALL0, ALL1 and PATTern. The PN generator function is explained in section 2.12.3, for example. If PATTern data type is used, the pattern can be modified with a special editor. The length is limited to 24 digits. IEC/IEEE-bus command : SOUR:W3GP:MST2:PRAC:DATA PN9 IEC/IEEE-bus command : SOUR:W3GP:MST2:PRAC:PATT #H1234, 15
TFCI	Value of the TFCI (Transport Format Combination Indicator) field in the control part of the PRACH. The value range of the TFCI is 0 to 1023. IEC/IEEE-bus command : SOUR:W3GP:MST2:PRAC:TFCI 123

Parameters in the PCPCH only mode:

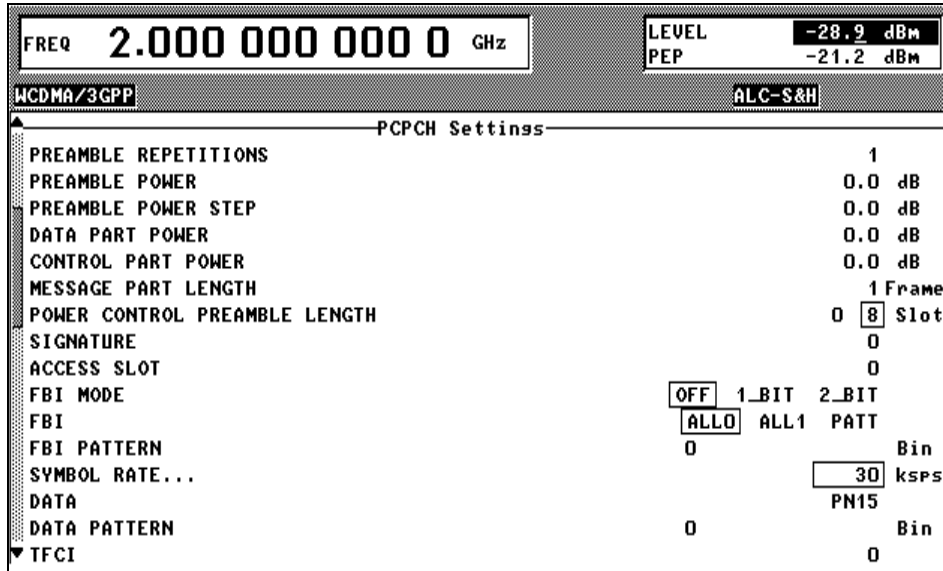

Fig. 2-121 DIGITAL STD – WCDMA/3GPP – MS CONFIGURATION: PCPCH only Mode menu

PREAMBLE REPETITIONS Number of repetitions of the preamble. Values between 1 and 10 can be selected.

IEC/IEEE-bus command : SOUR:W3GP:MST2:PCPC:PREP 3

PREAMBLE POWER Power of the preamble components of the PCPCHs. The value range of the power is from -60 dB to 0 dB.

IEC/IEEE-bus command : SOUR:W3GP:MST2: PCPC:PPOW -5

PREAMBLE POWER STEP The power by which the preamble is increased from repetition to repetition can be set. The value range is 0 dB to 10 dB.

Note: The preamble power that can be entered at the top of the panel is the destination power used in the last repetition of the preamble. If, for example, a preamble power of 0 dB, a repetition of 3 and a power step of 3 dB are set, the following power sequence will be generated:

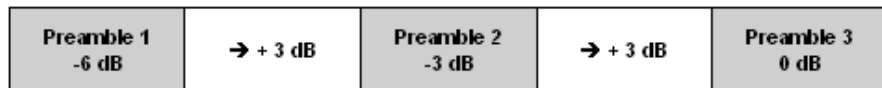

IEC/IEEE-bus command : SOUR:W3GP:MST2:PCPC:PPOW:STEP 3

DATA PART POWER Power of the data components of the PCPCH. The value range of the power is from -60 dB to 0 dB.

IEC/IEEE-bus command : SOUR:W3GP:MST2: PCPC:DPOW -3

CONTROL PART POWER Power of the control components of the PCPCH. The value range of the power is from -60 dB to 0 dB.

IEC/IEEE-bus command : SOUR:W3GP:MST2: PCPC:CPOW -7

SHARED RESOURCE MODE The Shared Resource Mode influences the type of the scrambling code in the access preamble and in the message part of the PCPCH. For more details refer to [1] section 5.2.2.2.2 and [2] section 4.3.4.4.

IEC/IEEE-bus command : SOUR:W3GP:MST2: PCPC:SHAR ON

MESSAGE PART LENGTH Length of the message in frames. Lengths between 1 and 10 frames can be set.

IEC/IEEE-bus command : SOUR:W3GP:MST2: PCPC:MLEN 3

POWER CONTROL PREAMBLE LENGTH	Length of Power Control Preamble in slots. Lengths between 0 and 8 slots can be set. IEC/IEEE-bus command : SOUR:W3GP:MST2:PCPC:PLEN 8
SIGNATURE	This field permits to determine the signature to be used for the PCPCH. Values between 0 and 15 can be set. IEC/IEEE-bus command : SOUR:W3GP:MST2: PCPC:SIGN 2
ACCESS SLOT#	Shifting of the starting time of the PCPCH. The value range is 0 to 14. (Shifting of the starting time in time slots can be calculated as follows: 2 * Access Slot #). IEC/IEEE-bus command : SOUR:W3GP:MST2: PCPC:ASLO 2
FBI MODE	<p>OFF The FBI field is not used in the frame. IEC/IEEE-bus command : SOUR:W3GP:MST2:PCPC:FBI:MODE OFF</p> <p>1 BIT The FBI field is used in the frame and is 1 bit long. IEC/IEEE-bus command : SOUR:W3GP:MST2:PCPC:FBI:MODE D1B</p> <p>2 BIT The FBI field is used in the frame and is 2 bits long. IEC/IEEE-bus command : SOUR:W3GP:MST2:PCPC:FBI:MODE D2B</p>
FBI / FBI PATTERN	<p>Selecting the data source for the FBI field.</p> <p>ALL0 All 0s are continuously entered in the FBI field. IEC/IEEE-bus command : SOUR:W3GP:MST2:PCPC:FBI:DATA ZERO</p> <p>ALL1 All 1s are continuously entered in the FBI field. IEC/IEEE-bus command : SOUR:W3GP:MST2:PCPC:FBI:DATA ONE</p> <p>PATT The FBI field is cyclically filled with a pattern that is up to 24 bits long. A special pattern editor is displayed. IEC/IEEE-bus commands : SOUR:W3GP:MST2:PCPC:FBI:DATA PATT : SOUR:W3GP:MST2:PCPC:FBI:PATT #H3F, 8</p>
SYMBOL RATE	Symbol rate of the PCPCH. All symbol rates between 15 ksps and 960 ksps are available. IEC/IEEE-bus command : SOUR:W3GP:MST2:PCPC:SRAT D30K
DATA / DATA PATTERN	Selection of the data source for the DATA field. Selection from PN9, PN11, PN15, PN16, ALL0, ALL1 and PATTern. The PN generator function is explained in section 2.12.3, for example. If PATTern data type is used, the pattern can be modified with a special editor. The length is limited to 24 digits. IEC/IEEE-bus command : SOUR:W3GP:MST2:PCPC:DATA PN9 IEC/IEEE-bus command : SOUR:W3GP:MST2:PCPC:PATT #H1234, 15
TFCI	Value of the TFCI (Transport Format Combination Indicator) field in the control part of the PCPC. The value range of the TF CI is 0 to 1023. IEC/IEEE-bus command : SOUR:W3GP:MST2:PCPC:TF CI 123

Parameters in the DPCCH + DPDCH mode:

FREQ	1.000 000 000 0 GHz				LEVEL	-30.0 dBm	
ALC-ON						CONTINUOUS	
DPCCH Settings							
POWER							0.0 dB
DL-UL TIMING OFFSET							1024 Chip
SLOT FORMAT	0	1	2	3	4	5	
TFCI STATE							OFF ON
TFCI							0
FBI MODE							OFF 1_BIT 2_BIT
FBI							ALL0 ALL1 PATT
FBI PATTERN	0						Bin
MISUSE TPC FOR OUTPUT POWER CTRL							OFF ON
TPC POWER STEP							0.0 dB
DPDCH Settings							
OVERALL SYMBOL RATE...							30 kSPS
POWER PER DPDCH							0.0 dB
CHANNEL NUMBER	1	2	3	4	5	6	
TYPE	DPDCH						
SYMBOL RATE	30						
CHAN CODE	32						
DATA	PN15						

Fig. 2-122 DIGITAL STD – WCDMA/3GPP – MS CONFIGURATION: DPCCH + DPDCH Mode menu

-----DPCCH Settings-----

- POWER** Channel power of the DPCCH, value range -60 to 0 dB
IEC/IEEE-bus command : SOUR:W3GP:MST2:DPCC:POW -3
- TIMING OFFSET** For the DPCCH (together with the DPDCHs), a fixed timing offset of 1024 chips (= 4 * 256 chips) is specified as standard. It is only displayed here and cannot be changed.
IEC/IEEE-bus command : SOUR:W3GP:MST2:DPCC:TOFF?
- SLOT FORMAT** Setting the TFCI STATE and FBI MODE parameters according to the following table :
- | SLOT FORMAT | TFCI STATE | FBI MODE |
|-------------|------------|----------|
| 0 | ON | OFF |
| 1 | OFF | OFF |
| 2 | ON | 1bit |
| 3 | OFF | 1bit |
| 4 | OFF | 2bits |
| 5 | ON | 2bits |
- TFCI STATE** ON The TFCI field is used in the frame.
IEC/IEEE-bus : SOUR:W3GP:MST1:DPCC:TFCI:STAT ON
- OFF The TFCI field is not used in the frame.
IEC/IEEE-bus : SOUR:W3GP:MST2:DPCC:TFCI:STAT OFF
- Note: Any changes of this parameter will affect the SLOT FORMAT parameter (see table under SLOT FORMAT).*
- TFCI** Setting the TFCI value in the range 0 to 1023. A combination of 30 bits is selected by this value. This combination is distributed over 15 successive slots in groups of two.
IEC/IEEE-bus command : SOUR:W3GP:MST4:DPCC:TFCI 21

FBI MODE OFF The FBI field is not used in the frame.
 IEC/IEEE-bus : SOUR:W3GP:MST2:DPCC:FBI:MODE OFF

1 BIT The FBI field is used in the frame and is 1 bit long.
 IEC/IEEE-bus : SOUR:W3GP:MST2:DPCC:FBI:MODE D1B

2 BIT The FBI field is used in the frame and is 2 bits long.
 IEC/IEEE-bus : SOUR:W3GP:MST2:DPCC:FBI:MODE D2B

Note: Any changes of this parameter will affect the SLOT FORMAT parameter (see table under SLOT FORMAT).

FBI / FBI PATTERN Selecting the data source for the FBI field.

ALL0 All 0s are continuously entered in the FBI field.
 IEC/IEEE-bus command
 : SOUR:W3GP:MST2:PCPC:FBI:DATA ZERO

ALL1 All 1s are continuously entered in the FBI field.
 IEC/IEEE-bus command
 : SOUR:W3GP:MST2:PCPC:FBI:DATA ONE

PATT The FBI field is cyclically filled with a pattern that is up to 24 bits long. A special pattern editor is displayed.
 IEC/IEEE-bus commands:
 : SOUR:W3GP:MST2:DPCC:FBI:DATA PATT
 : SOUR:W3GP:MST2:DPCC:FBI:PATT #H3F, 8

MISUSE TPC FOR OUTPUT POWER CONTROL

TPC bits are used for W-CDMA to inform the called station if the transmit power is being increased or decreased. If this option is activated, the given pattern is being misused to vary one's own transmit power over time. For each slot, one bit of this pattern is taken to increase (bit = 1) or decrease (bit = 0) the channel power by the stated power step (**POWER STEP TPC**). The upper limit is 0 dB and the lower -60 dB.

The following envelope occurs at a channel power of 0 dB, a power step of 1.0 dB, the pattern "001110100000011" and TPC Pattern ReadOut Mode **Continuous**:

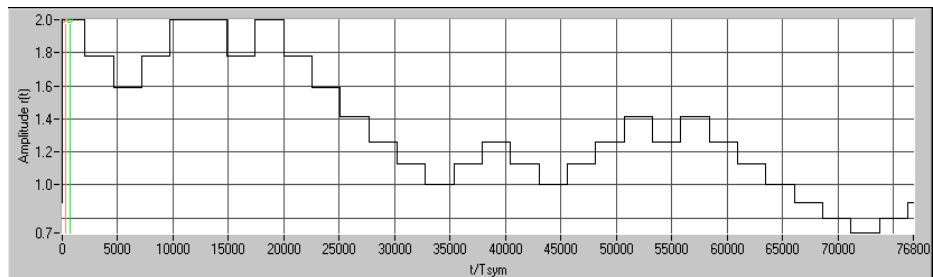

Fig. 2-123 Dynamic change of channel power (continuous)

Note: Observe that the power change (as specified in the standard) is always performed at the beginning of the slot pilot field.

IEC/IEEE-bus command : SOUR:W3GP:MST1:DPCC:TPC:MIS ON

TPC POWER STEP

Size of power step in dB, if option **MISUSE TPC FOR OUTPUT POWER CONTROL** is activated.

The range is -10.0 dB to +10.0 dB.

IEC/IEEE-bus command : SOUR:W3GP:MST1:DPCC:TPC:PST 1.0

-----DPDCH Settings-----

ENHANCED CHANNELS... Calling an operating menu for the configuration of extended functions of the digital standard 3GPP W-CDMA. The menu item is available only if option SMIQB48 is installed. For more details on this menu see section "Enhanced Functions for Digital Standard 3GPP W-CDMA".

OVERALL SYMBOL RATE Overall data rate of all uplink DPDCHs. The structure of the DPDCH table depends on this parameter. The overall symbol rate indicates the active DPDCHs, their symbol rate and the channelization codes used (see table further down).

Value range: off, 15 ksps, 30 ksps, 60 ksps, 120 ksps, 240 ksps, 480 ksps, 960 ksps, 2 x 960 ksps, 3 x 960 ksps, 4 x 960 ksps, 5 x 960 ksps and 6 x 960 ksps.

If **OFF** is selected, the signal only consists of one DPDCH. In this case, no channel table is displayed.

IEC/IEEE-bus command : SOUR:W3GP:MST1:DPDC:ORAT D60K

POWER PER DPCH Power of active DPDCHs. Each active DPDCH features this channel power. The power of the active channels cannot be configured independently (this also complies with the definition of 3GPP). Value range -60...0.0 dB.

IEC/IEEE-bus command : SOUR:W3GP:MST1:DPDC:POW -23

Table 2-23 Structure of the DPDCH channel table depending on the overall symbol rate

Overall symbol rate	DPDCH 1	DPDCH 2	DPDCH 3	DPDCH 4	DPDCH 5	DPDCH 6
15 ksps	State: ON S-Rate: 15 k Ch. Code: 64	State: OFF	State: OFF	State: OFF	State: OFF	State: OFF
30 ksps	State: ON S-Rate: 30 k Ch. Code: 32	State: OFF	State: OFF	State: OFF	State: OFF	State: OFF
60 ksps	State: ON S-Rate: 60 k Ch. Code: 16	State: OFF	State: OFF	State: OFF	State: OFF	State: OFF
120 ksps	State: ON S-Rate: 120 k Ch. Code: 8	State: OFF	State: OFF	State: OFF	State: OFF	State: OFF
240 ksps	State: ON S-Rate: 240 k Ch. Code: 4	State: OFF	State: OFF	State: OFF	State: OFF	State: OFF
480 ksps	State: ON S-Rate: 480 k Ch. Code: 2	State: OFF	State: OFF	State: OFF	State: OFF	State: OFF
960 ksps	State: ON S-Rate: 960 k Ch. Code: 1	State: OFF	State: OFF	State: OFF	State: OFF	State: OFF
2 x 960 ksps	State: ON S-Rate: 960 k Ch. Code: 1	State: ON S-Rate: 960 k Ch. Code: 1	State: OFF	State: OFF	State: OFF	State: OFF
3 x 960 ksps	State: ON S-Rate: 960 k Ch. Code: 1	State: ON S-Rate: 960 k Ch. Code: 1	State: ON S-Rate: 960 k Ch. Code: 3	State: OFF	State: OFF	State: OFF
4 x 960 ksps	State: ON S-Rate: 960 k Ch. Code: 1	State: ON S-Rate: 960 k Ch. Code: 1	State: ON S-Rate: 960 k Ch. Code: 3	State: ON S-Rate: 960 k Ch. Code: 3	State: OFF	State: OFF
5 x 960 ksps	State: ON S-Rate: 960 k Ch. Code: 1	State: ON S-Rate: 960 k Ch. Code: 1	State: ON S-Rate: 960 k Ch. Code: 3	State: ON S-Rate: 960 k Ch. Code: 3	State: ON S-Rate: 960 k Ch. Code: 2	State: OFF
6 x 960 ksps	State: ON S-Rate: 960 k Ch. Code: 1	State: ON S-Rate: 960 k Ch. Code: 1	State: ON S-Rate: 960 k Ch. Code: 3	State: ON S-Rate: 960 k Ch. Code: 3	State: ON S-Rate: 960 k Ch. Code: 2	State: ON S-Rate: 960 k Ch. Code: 2

Note: With an overall rate smaller than 960 ksps only DPDCH1 is active, its rate is equal to the overall rate and the channelization code is equal to spreading factor/4 (spreading factor = chip rate / symbol rate). With an overall rate greater than 960 ksps, all active DPDCHs have the rate 960 ksps.

Channel table of the DPDCHs:

SYMBOL RATE	The symbol rate of the DPDCH is displayed. This parameter cannot be changed. Its value depends on the overall symbol rate. IEC/IEEE-bus command : SOUR:W3GP:MST1:DPDC2:SRAT?
CHANNELIZATION CODE	The channelization code of the DPDCH is displayed. This parameter cannot be changed. Its value depends on the overall symbol rate. IEC/IEEE-bus command : SOUR:W3GP:MST1:DPDC2:CCOD?
DATA	Selection of the data source for the DATA field. Selection from PN9, PN11, PN15, PN16, ALL0, ALL1 and PATTern. The PN generator function is explained in section 2.12.3, for example. If PATTern data type is used, the pattern can be modified with a special editor. The length is limited to 24 digits. IEC/IEEE-bus : SOUR:W3GP:MST3:DPDC3:DATA PN15 : SOUR:W3GP:MST3:DPDC3:DATA:PATT #H1234, 15

2.14.2.7 WCDMA/3GPP – Multi Channel Edit Menu

When MULTI CHANNEL EDIT is selected, a submenu in which several DPCHs can be configured is opened. This menu item is only available for base stations.

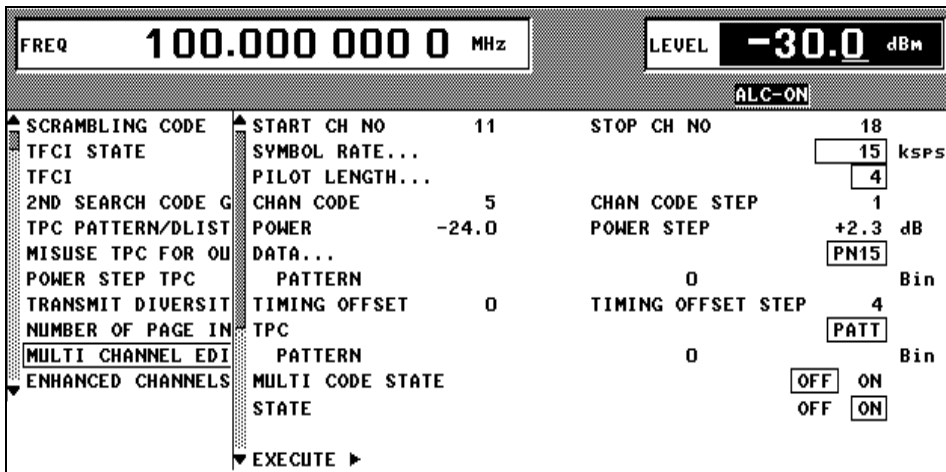

Fig. 2-124 DIGITAL STD – WCDMA/3GPP – BS CONFIGURATION / MULTI CHANNEL EDIT menu

In this submenu, all parameters in the channel table can be set for a group of DPCHs. The parameter ranges are identical to those in the channel table.

MULTI CHANNEL EDIT...	START CH NO (DPCH) STOP CH NO (DPCH)	Range of DPCHs that are to be commonly configured. Range 11 to 138. IEC/IEEE-bus command: : SOUR:W3GP:MCH:STAR 14 IEC/IEEE-bus command: : SOUR:W3GP:MCH:STOP 54
	SYMBOL RATE	Symbol rate of DPCHs: 7.5 kSPS, 15 kSPS, 30 kSPS, 60 kSPS, 120 kSPS, 240 kSPS, 480 kSPS or 960 kSPS IEC/IEEE-bus command: : SOUR:W3GP:MCH:SRAT D64K

(MULTI CHANNEL EDIT...)	PILOT LENGTH	<p>Length of the pilot field in the slot structure of a channel. The value range of this parameter depends on the symbol rate (2 bits to max. 16 bits). To achieve a constant length of the slot the data fields are lengthened or shortened depending on the pilot length as defined in the standard.</p> <p>IEC/IEEE-bus : SOUR:W3GP:MCH:PLEN BIT2</p>
	CHANNELIZATION CODE / STEP	<p>Channelization code for the first channel and step width for all other channels. The value ranges depend on the symbol rate.</p> <p>IEC/IEEE-bus commands : SOUR:W3GP:MCH:CCOD 4 : SOUR:W3GP:MCH:CCOD:STEP 1</p>
	POWER / dB POWER STEP / dB	<p>Channel power for the first channel (value range -60 dB to 0 dB) and stepwidth for all other channels (value range -60 dB to 60 dB).</p> <p>IEC/IEEE-bus commands : SOUR:W3GP:MCH:POW -20 : SOUR:W3GP:MCH:POW:STEP 1</p>
	DATA	<p>Selection of data pattern for the DPCHs. For other patterns see channel table.</p> <p>IEC/IEEE bus commands : SOUR:W3GP:MCH:DATA PN9 : SOUR:W3GP:MCH:DATA:PATT #HFFFF, 16</p>
	TIMING OFFSET / TIMING OFFSET STEP	<p>A value > 0 causes the source symbols to be shifted prior to spreading. An offset of 1 for instance is recommended to obtain a lower crest factor.</p> <p>The absolute starting time of frames (slot 0) is shifted relative to the start of the scrambling code sequence by $T_{\text{Offset}} * 256$ chips. This means that the resolution of the timing offset is always 256 chips, irrespective of the symbol rate. The step width of the timing offset between two adjacent channels is defined with STEP.</p> <p>IEC/IEEE bus commands : SOUR:W3GP:MCH:TIM:OFFS 0 : SOUR:W3GP:MCH:TIM:STEP 3</p>
	TPC	<p>Data source for the TPC field.</p> <p>IEC/IEEE-bus : SOUR:W3GP:MCH:TPC ZERO</p>
	MULTI CODE STATE	<p>ON The channels should be simulated with multicode. IEC/IEEE bus : SOUR:W3GP:MCH:MCOD ON</p> <p>OFF The channels should be simulated without multicode. IEC/IEEE bus : SOUR:W3GP:MCH:MCOD OFF</p>
	STATE	<p>ON The channels are active. IEC/IEEE bus : SOUR:W3GP:MCH:STAT ON</p> <p>OFF The channels are not active. IEC/IEEE bus : SOUR:W3GP:MCH:STAT OFF</p>
	EXECUTE ►	<p>Configuration of DPCHs according to the set parameters.</p> <p>IEC/IEEE bus : SOUR:W3GP:BST2:MCH:EXEC</p>

The channel parameter ranges correspond to the associated parameters in the channel table (see above).

Start Channel No (DPCH)/Stop Channel No (DPCH): The range of the DPCHs that are to be set jointly is defined.

For channel scenarios to be set up easily, start values and step widths can be entered for some parameters which are used to set the channel parameters. **Channelization Code** and **Channelization Code Step** parameters, for example, can be used to create simple scenarios in which spreading codes with a fixed step width are assigned to the various code channels. Power profiles (via the code axis) can be created in the same way with **power** and **power step**. The **timing offset** and **timing offset step** parameters can be used to change the relative slot timings of the channels, so changing the crest factor of the signal (see section 2.14.3.4).

2.14.2.8 WCDMA/3GPP – Display of Channel Graph Menu

The channel graph provides an overview of the contents of the channel table.

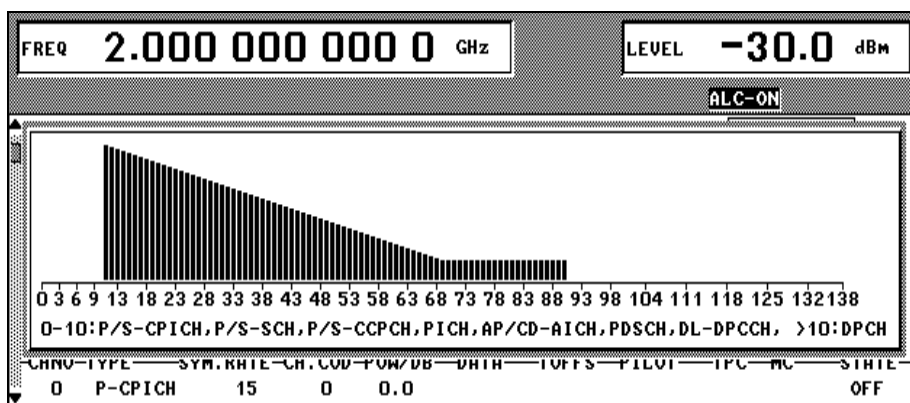

Fig. 2-125 DIGITAL STD – WCDMA/3GPP – BS CONFIGURATION /CHANNEL GRAPH menu

All active channels and their channel powers are displayed. Unlike the code domain display (next chapter), all channels are shown with the same width. Multiple assignment of a code domain range cannot be recognized.

2.14.2.9 WCDMA/3GPP Menu – Display of Code Domain and Code Domain Conflicts

The channelization codes are taken from a code tree (see below).

The greater the spreading factor, the smaller the symbol rate and vice versa. The product of the spreading factor and the symbol rate is constant and always equals the current chip rate. The outer branches of the tree (right-most position in the figure) give the channelization codes for the lowest symbol rate (and so the highest spreading factor). The use of a channelization code from the level with a spreading factor N blocks the use of all other channelization codes from levels with spreading factor >N in the same branch of the code tree. Channelization codes with a smaller spreading factor are contained in the codes with larger spreading factor in the same code branch. If channelization codes of this type are used at the same time, the signals of associated code channels will be mixed up to such an extent that they could not be separated in the receiver and orthogonality would be lost.

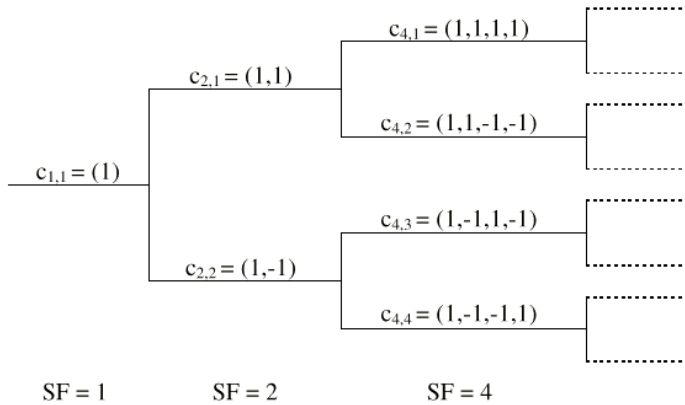

Fig. 2-126 Code tree of channelization codes

Example: If in Fig. 2-126 code $c_{2,1}$ is already used, the remaining branch is blocked with $c_{4,1}$ and $c_{4,2}$.

The outer branch region (with minimum symbol rate and max. spreading factor) which is based on the channelization code selected in the code tree is defined as the **domain** of a certain channelization code. Using a channelization code means that its entire domain is used. The whole domain ranges from 0 to 511 at the chip rate of 3.84 Mcps:

$$= \frac{\text{Chip_rate}}{\text{min_symbol_rate}} - 1 = \frac{3.84\text{Mcps}}{7.5\text{ksps}} - 1$$

A graphic is displayed with the **CODE DOMAIN** menu item or the **STATUS** hardkey. This graphic shows the occupancy of the code domain by the active code channels.

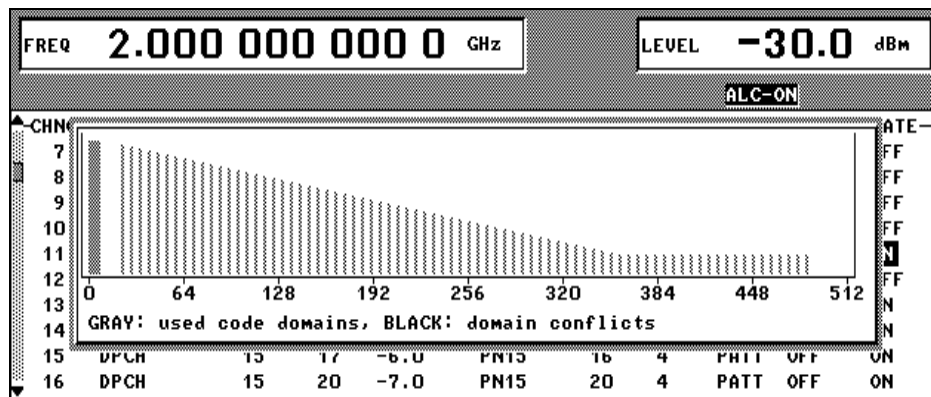

Fig. 2-127 WCDMA/3GPP – BS CONFIGURATION / CODE DOMAIN menu (without conflict)

This display shows at a glance whether assigned code domains of various channels overlap, i.e. whether a domain conflict occurs. The symbol rates of code channels are indicated by the width of the associated bars. The height of the bars gives the power of the code channel. If a bar is grey, the code domain at this position is assigned once which means that no conflicts occur. If a bar is black (at least partly), the code domain is assigned at least twice and conflicts occur.

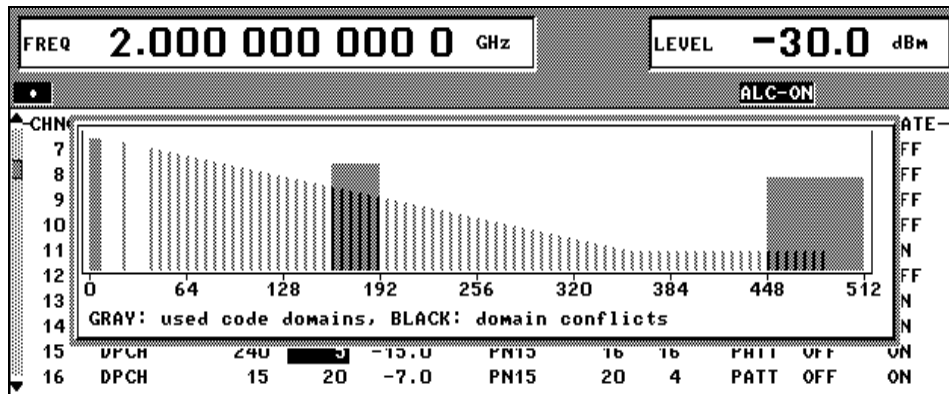



Fig. 2-128 WCDMA/3GPP – BS CONFIGURATION / CODE DOMAIN menu (with conflict)

Display of domain conflicts

If a domain conflict occurs in the base station/mobile station, this conflict is displayed at two locations (next to the code domain display).

1. Centrally for the whole station in the status line 
2. All lines in the channel table (processed in ascending channel numbers) showing a domain conflict in a row with a lower index are indicated with a warning symbol  to the left of STATE.

A domain conflict occurs when the assigned domains of different channel rows overlap. The assigned code domain of a channel is calculated from the symbol rate of the channel, the minimum possible symbol rate (depending on the link direction), the chip rate and the channelization code number using the following equation:

$$Domain_factor = \frac{current_symbolrate}{minimum_symbolrate} \text{ (the minimum symbol rate is 7.5 ksp/s in downlink),}$$

where:

- Lower domain limit** = current channelization code number * domain factor
- Upper domain limit** = lower domain limit + domain_factor - 1.

If the cursor is positioned on one of the warning symbols  and if the SELECT button is clicked, a window is opened and shows more accurate information about the domain conflict that has occurred. The numbers of channel rows in the channel table and the assigned domains of the conflicting channels are displayed.

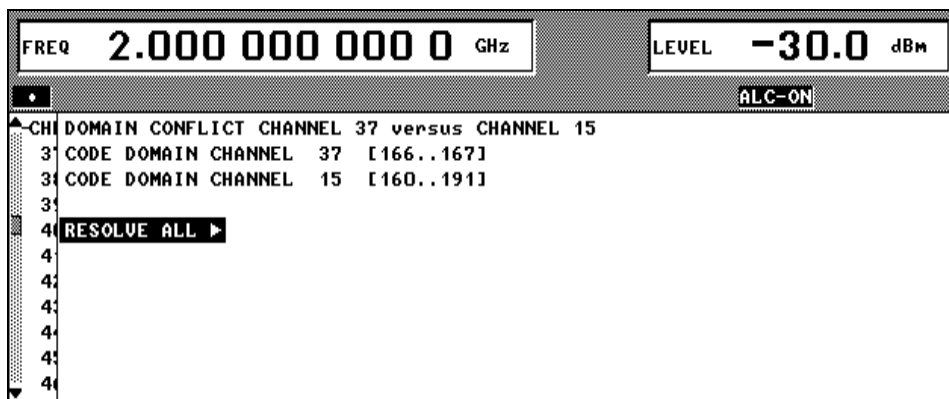

Fig. 2-129 WCDMA/3GPP – BS CONFIGURATION / CODE DOMAIN CONFLICT menu

Resolve all Conflicts

If you select the **RESOLVE ALL** button in the domain conflict info window, the SMIQ tries to arrange the active code channels so that no overlapping occurs in the code domain. The channelization code number of the channels is varied to do this. The effect of a conflict resolution is shown by the code domain display.

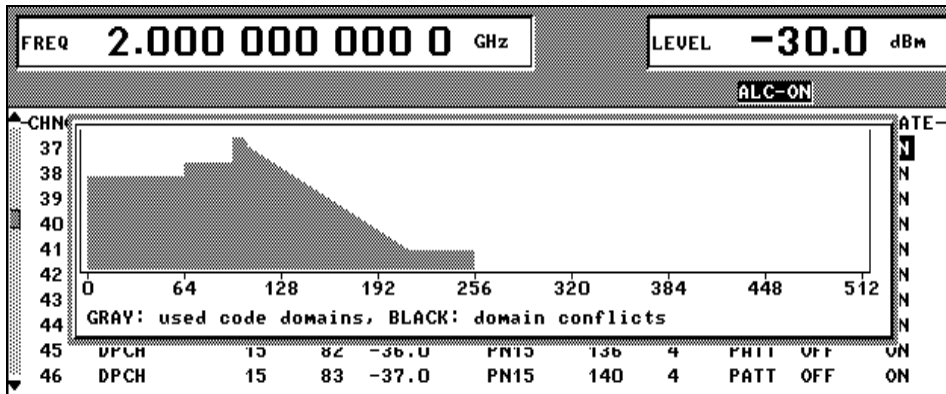

Fig. 2-130 WCDMA/3GPP – BS CONFIGURATION / CODE DOMAIN menu (after conflict resolution)

If the assigned domain of all active channels is greater than the physically available domain (e.g. 5 channels with 960 ksps at a chip rate of 3.84 Mcps), conflicts can no longer be resolved. The message "no resolution of domain conflicts possible" is displayed.

2.14.2.10 Effect of CLIPPING LEVEL Parameter on Signal

W-CDMA signals may have very high crest factors - especially if the number of channels is high and the data offset is unfavourable (see sections 2.14.3.3 and 2.14.3.4). High crest factors entail two basic problems:

1. The nonlinearity of the power amplifier (compression) causes intermodulation which expands the spectrum (spectral regrowth).
2. Since the level in the D/A converter is relative to the maximum value, the average value is converted with a relatively low resolution. This results in a high quantization noise.

Both effects increase the adjacent-channel power.

From all the possibilities listed in section 2.14.3.4 for influencing the crest factor, changing the CLIPPING LEVEL is the simplest and most effective. In this case a limit value is defined which is a percentage of the highest peak value. All current values exceeding this limit will be clipped to this value. Since clipping is done prior to filtering, the procedure does not influence the spectrum. The EVM however increases. Since clipping the signal not only changes the peak value but also the average value, the effect on the crest factor is unpredictable. The following table shows the effect of the CLIPPING LEVEL on the crest factor for typical scenarios.

Table 2-24 Change of crest factor in the case of clipping

CLIPPING LEVEL	Crest factor with scenario			
	Downlink: 10 DPCHs "minimum crest" 30 ksp/s	Downlink: 10 DPCHs "worst crest" 30 ksp/s	Downlink: 10 DPCHs "average crest" 30 ksp/s	Downlink: 128 DPCHs "average crest" 30 ksp/s
100%	9.89 dB	14.7 dB	10.9 dB	21.7 dB
80%	8.86 dB	12.9 dB	9.39 dB	20.2 dB
50%	7.50 dB	10.1 dB	8.29 dB	16.9 dB
20%	5.50 dB	6.47 dB	6.23 dB	12.5 dB
10%	5.34 dB	6.06 dB	5.80 dB	9.57 dB
5%	5.34 dB	6.06 dB	5.80 dB	8.17 dB

Effect of clipping on the constellation shown by way of a 4-DPCH configuration:

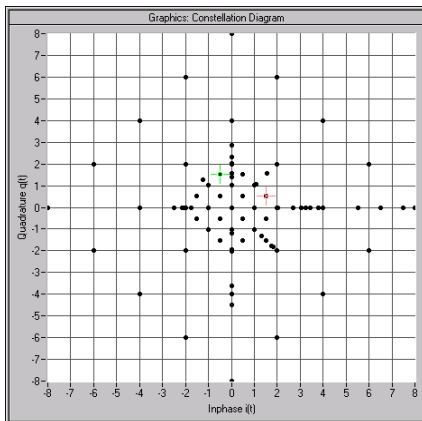

Fig. 2-131 Constellation at clipping level 100% (not clipped)

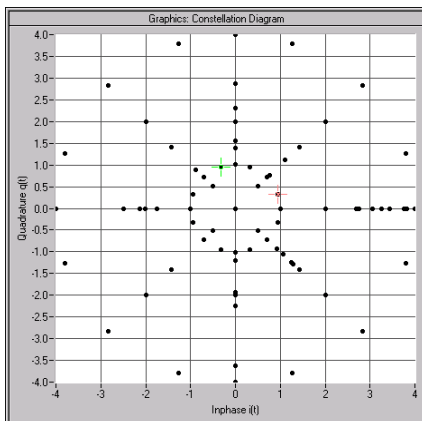

Fig. 2-132 Constellation at clipping level 50%

2.14.2.11 Synchronization and Trigger Signals

To generate the W-CDMA signals, a chip sequence is calculated and stored in the waveform memory of the modulation coder (option SMIQB20). This chip sequence is automatically repeated (TRIGGER MODE AUTO).

For measurements on receivers, trigger signals can also be used for synchronized sequences (TRIGGER MODE RETRIG, ARMED_AUTO or ARMED_RETRIG).

The trigger signal is applied to the TRIGIN input of the PAR DATA connector. The chip sequence either starts immediately after the active edge of this trigger signal or after a settable number of chips (EXT TRIGGER DELAY). A retrigger (RETRIG) can be inhibited for a settable number of chips (EXT RETRIGGER INHIBIT).

A trigger event can be triggered manually with EXECUTE TRIGGER or via the IEC/IEEE bus. A trigger signal is always output at TRIGOUT 3 output of the SMIQ at the same time as a trigger event.

The SMIQ generates the following sync signals:

- a 0.667 ms slot clock
- a 10 ms radio-frame clock
- a marker signal to identify the periodic repetition of the generated chip sequence
- a marker signal to identify the periodic repetition of the generated enhanced chip sequence (only available if Option SMIQB48 is installed)
- a marker signal to identify a restart of the system frame number (SFN Restart) after 4096 frames (only available if Option SMIQB48 is installed and a BCH is generated).

The SMIQ can output a selection of two or three signals via connectors TRIGOUT 1 and 2 of the PAR DATA connector.

The chip clock in the SMIQ is generated by a clock synthesizer in the modulation coder. All clock signals are in sync with the unit's 10 MHz reference. The chip clock is available at the SYMBOL CLOCK connector. If required, the clock synthesizer in the SMIQ can use an external chip clock which is fed in via the SYMBOL CLOCK connector.

To ensure reliable clock-synthesizer synchronization, the external clock must first be applied and the correct SMIQ chip rate set (MODULATION – CHIPRATE VARIATION). The CLOCK SOURCE can then be switched from INT to EXT.

Note: *The set chip rate may not differ by more than 1% from the chip rate of the external signal.*

2.14.2.12 Preset/Default Values

The following settings are made if the menu item SET DEFAULT is selected or if the PRESET key is pressed during switch-on.

General default settings

CHIP RATE 3.84 Mcps
 LINK DOWN/FORWARD
 3GPP VERSION 3.2.0 (RELEASE 99)
 MODULATION WCDMA filter, roll-off 0.22, LOW ACP, chip rate of 3.84 Mcps
 TRIGGER
 MODE RETRIG
 SOURCE INT
 DELAY 0
 INHIBIT 0
 OUT 1 RADIO FRAME
 OUT 2 CHIP SEQUENCE PERIOD
 OUT1/2 POL POS
 OUT ½ DELAY 0
 CLOCK SOURCE INT
 CLOCK DELAY 0.00
 SEQUENCE LENGTH 1

Default settings for DOWN/FORWARD Link

Para. Predef. settings

CHANNELS FOR SYNC... ON
 SCCPCH 60 ksps
 NO OF DPCH 3
 SYMBOL RATE 30 ksps
 CREST MINIMUM

Base station parameters

Table 2-25 Default values for base station parameters

Parameter	BS1	BS2	BS3	BS4
STATE	OFF	OFF	OFF	OFF
SCRAMBLING CODE STATE	ON	ON	ON	ON
SCRAMBLING CODE	0	0	0	0
USE TFCI	OFF	OFF	OFF	OFF
TFCI	0	0	0	0
2nd SEARCH CODE GR.	0	0	0	0
Misuse TPC...	OFF	OFF	OFF	OFF
TPC Read Out Mode	continuous	continuous	continuous	continuous
Power Step	0	0	0	0
Transmit Diversity	OFF	OFF	OFF	OFF
Page indicators per frame	18	18	18	18

Multi Channel Edit

START DPCH	11
STOP DPCH	11
SYMBOL RATE	30 ksym/s
PILOT LENGTH	4 bit
CHAN. CODE	0
CHAN. STEP	0
POWER	0dB
POWER STEP	0dB
DATA	PN15
TIMING OFFSET	0
TIMING OFFSET STEP	0
TPC	ALL 0 (0)
MULTI CODE STATE	OFF
STATE	ON

Channel table parameters

SYMBOL RATE	15 kbps (if possible, otherwise min. permissible rate)
CHAN. CODE	0 (if possible, otherwise min. permissible code)
POWER	0 dB
DATA	PN15
TIMING OFFSET	0
PILOT LENGTH	4 bit (if possible, otherwise min. permissible length)
TPC	ALL 0 (0)
MC STATE	OFF
DATA PATTERN	"0000 0000 0000 0000"
TPC PATTERN	"0000 0000 0000 0000"

Default settings for UP/REVERSE link

Mobile station parameters

Table 2-26 Default values for mobile station parameters

Parameters	MS1	MS2	MS3	MS4
STATE	OFF	OFF	OFF	OFF
MODE	DPCCH + DPDCH	DPCCH + DPDCH	DPCCH + DPDCH	DPCCH + DPDCH
SCRAMBLING CODE	0	0	0	0
SC MODE	LONG	LONG	LONG	LONG
TPC READ OUT MODE	CONTINUOUS	CONTINUOUS	CONTINUOUS	CONTINUOUS
TPC	All 0	All 0	All 0	All 0

Parameter PRACH only mode:

PREAMBLE REPETITION 1
 PREAMBLE POWER 0 dB
 DATA PART POWER 0 dB
 CONTROL PART POWER 0 dB
 Message Part Length 1
 SIGNATURE 0
 ACCESS SLOT 0
 SYMBOL RATE 30 ksps
 DATA PN15
 DATA PATTERN "0000 0000 0000 0000"
 TFCI 0

Parameter PCPCH only mode:

PREAMBLE REPETITION 1
 PREAMBLE POWER 0 dB
 PREAMBLE POWER STEP 0 dB
 DATA PART POWER 0 dB
 CONTROL PART POWER 0 dB
 MESSAGE PART LENGTH 1
 Power CONTROL
 PREAMBLE LENGTH 0 slots
 SIGNATURE 0
 ACCESS SLOT 0
 FBI MODE OFF
 FBI ALL 0
 FBI PATTERN "0000 0000 0000 0000"
 SYMBOL RATE 30 ksps
 DATA PN15
 DATA PATTERN "0000 0000 0000 0000"
 TFCI 0

Parameter DPCCH + DPDCH mode:**DPCCH settings**

POWER	0 dB
TIMING OFFSET	4 (fix)
TFCI STATE	OFF
TFCI	0
FBI MODE	OFF
FBI	ALL 0
FBI PATTERN	"0000 0000 0000 0000"
MISUSE TPC...	OFF
TPC POWER STEP	0 dB
PREAMBLE POWER	0 dB
PREAMBLE POWER STEP	0 dB
DATA PART POWER	0 dB
CONTROL PART POWER	0 dB
SHARED RESOURCE...	OFF
MESSAGE PART LENGTH	1

DPDCH settings

OVERALL SYMBOL RATE	30 ksps
POWER	0 dB
DATA	PN15 (for all DPDCHs)

2.14.3 Background Information for the Generation of 3GPP W-CDMA Signals

This section provides some background information on W-CDMA signals to support the user in generating signals with certain characteristics.

2.14.3.1 3GPP W-CDMA Signals in Time Domain

For information on 3GPP W-CDMA signals in the frequency domain refer to section 2.14.3.2.

Downlink

The two spreading methods for SCHs and the remaining (downlink) channel types are explained for the channels P-CCPCH, P-SCH and S-SCH. (These three channels were referred to as "Perch" in previous versions of the W-CDMA standard and option SMIQB45)

A (downlink) signal containing the following components is generated:

- P-CCPCH (-20 dB)
- P-SCH (-14 dB)
- S-SCH (-14 dB)

The SCH components are generated with double amplitude for better distinction against PCCPCH.

Sequence length = 1

Filtering: root cosine (roll-off = 0.22), impulse length = 32, oversampling = 8

Data source: PRBS23

No superimposed impairments active

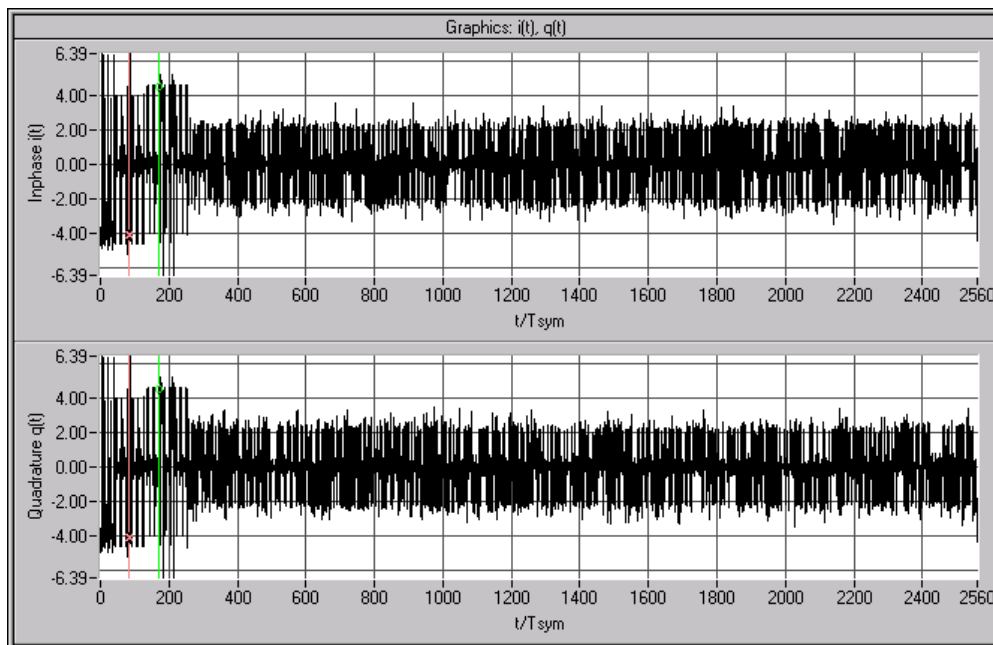

Fig. 2-133 Signal consisting of P-CCPCH, P-SCH and S-SCH in time domain

The above diagram reveals that a time slot consists of 2560 chips and the power is higher with the first 10% of the signal. This is the SCH. Zooming in on this transition point reveals the following:

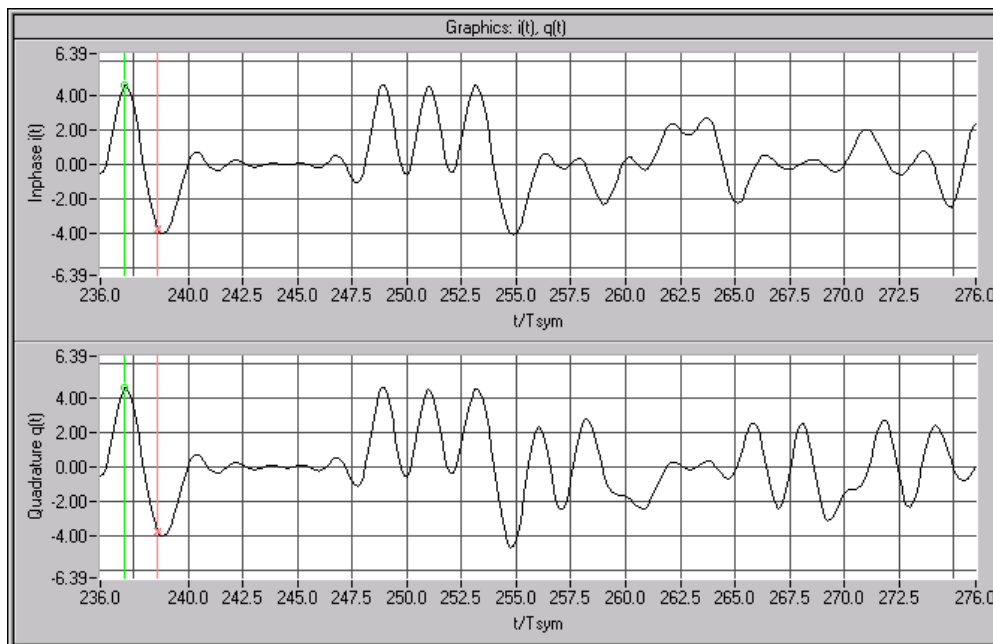

Fig. 2-134 Signal consisting of P-CCPCH, P-SCH and S-SCH in time domain (zoomed)

The right section (i.e. the 9 PCCPCH symbols) is spread as described in Fig. 2-90. You can see that for each symbol clock one of the two components is 0 and the other one ± 2 (a certain inaccuracy results from the root cosine filter used).

This is the standard spreading scheme as it is also used for S-CCPCH, DPCH and all other downlink channel types.

The left section (the synchronization code symbol occupying the chip range 0 to 255) is obtained using special synchronization code spreading: there is no scrambling unit ($S_i = C_i, S_q = C_q$).

Since the synchronization code symbol is defined as 11, the following is always true:

$$S_i = S_q.$$

The result is a BPSK mapping turned by 45° relative to the QPSK constellation of the S-CCPCH component.

Since the synchronization code symbol is sent twice (in the primary and secondary SCH) with different spreading, the signal power is doubled in this range.

The constellation diagram of the perch channel, therefore, has the following appearance:

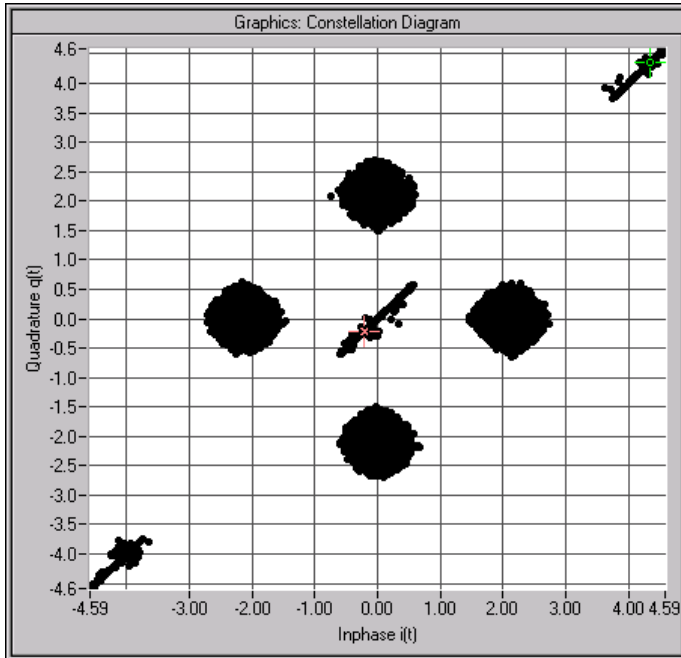

Fig. 2-135 Constellation diagram of a signal consisting of P-CCPCH, P-SCH and S-SCH

The four circular areas are due to P-CCPCH ("QPSK"), the linear areas (diagonals) to SCH ("BPSK"). The spreading/constellation diagram of P-CPICH, S-CPICH, S-CCPCH, PICH, AP-AICH, AICH, PDSCH, DL-DPCCH and DPCH are identical to the spreading/constellation diagram of P-CCPCH.

Envelopes

The following figures are based on a power of 0 dB.

To eliminate smearing of the amplitude due to the root cosine filter, all envelopes are calculated using a squarewave filter.

The channels P-CPICH, S-CPICH, S-CCPCH, PICH, PDSCH feature a constant envelope during the complete sequence.

Note: Section 2.14.2.5, "Misuse TPC for output power control", describes how the envelope of e.g. DPCHs can be varied.

The P-CCPCH is blanked during the first 256 chips of the slot.

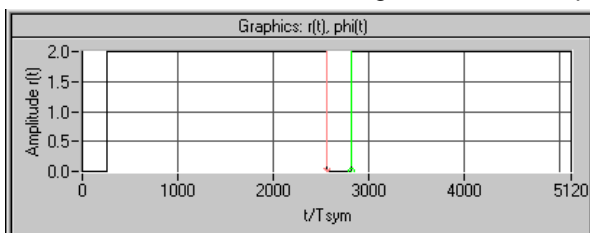

Fig. 2-136 Envelope of P-CCPCH

P-SCH and S-SCH are active during the first 256 chips only:

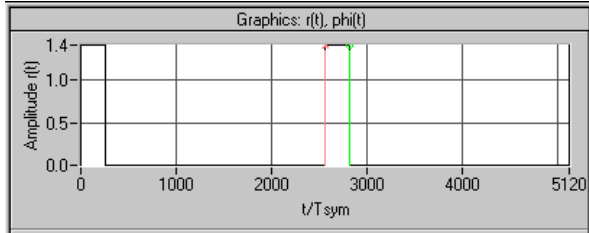

Fig. 2-137 Envelope of P-SCH or S-SCH

AP-AICH and AICH are transmitted only during the first 4096 chips of the signal:

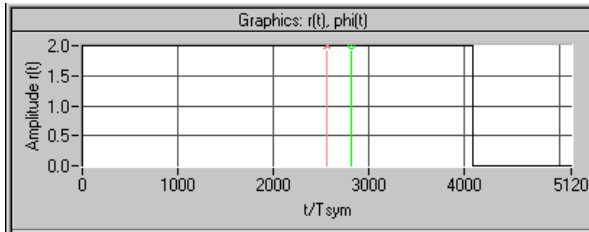

Fig. 2-138 Envelope of AICH (Subchannel)

AP-AICH and AICH consist of up to 16 superimposed single channels that are modulated with different orthogonal vectors. In some sections, cancellations or excessive levels may result. The following diagram shows the signal with the input pattern "1010":

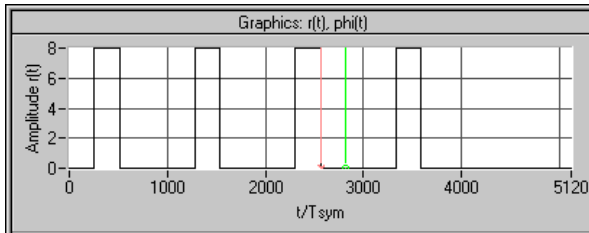

Fig. 2-139 Envelope of AICH (four subchannels)

The DL-DPCCH is used during transmission of the PCPCH to readjust the output power of the mobile. Since there is no data transfer to the mobile in this phase, the DL-DPCCH is based on a DPCH (7.5 kbps without TFCI), the data fields of which are blanked ("DTX"):

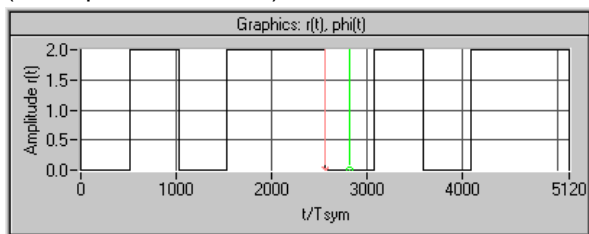

Fig. 2-140 Envelope of DL-DPCCH

At first, DPCHs are permanently active, however the TFCI fields are blanked at high data rates (≥ 60 kbps) if no TFCI information is transferred ("DTX"). A 60-kbps channel, for example, then has the following appearance:

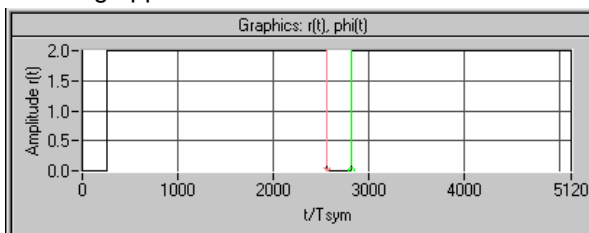

Fig. 2-141 Envelope of DPCH 60 kbps without TFCI

Uplink

In the "DPCCH+DPDCH" mode, the signal consists of a DPCCH and one or several (max. 6) DPDCHs. To derive the constellation of this signal, the constellation of a single channel (DPDCH or DPCCH) is considered first. Its data are exclusively supplied to the I or Q path. The second path is not used (second path is: $C_q = 0$).

with

$$\begin{aligned} S_i &= C_i S C_i - C_q S C_q' \\ S_q &= C_i S C_q' + C_q S C_i \end{aligned}$$

the following equation is obtained:

$$\begin{aligned} S_i &= C_i S C_i \\ S_q &= C_i S C_q' \end{aligned}$$

This corresponds to a QPSK constellation diagram. Compared to the DPCH constellation diagram, this diagram is shifted and the constellation points only have half the amplitude:

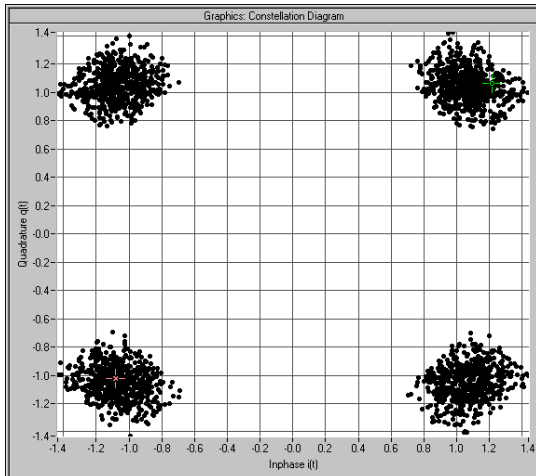

Fig. 2-142 Constellation of a DPDCH/DPCCH channel

Note: A suitable modification of the PN sequences ("HPSK") in the uplink eliminates 50 % of all zero-crossings, which, in contrast to the downlink, causes a deformation of the constellation ranges.

If DPCCH and DPDCH are combined, the constellation considerably depends on the ratio of the channel powers. If the two powers are equal, a constellation as with the P-CCPCH will be obtained. The following illustration shows the constellation with DPCCH power 0dB and DPDCH power -6 dB:

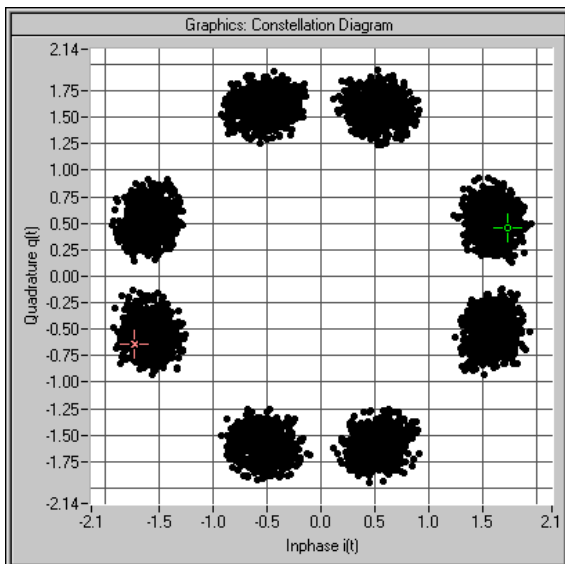

Fig. 2-143 Constellation of an uplink signal consisting of a DPDCH and a DPCCH

PRACH and PCPCH consist of preambles and the message part. Similar to a P-CCPCH, the preamble uses the 4 constellation points (2, 0), (0,2), (-2, 0) and (0, -2). In the case of the message part, separate powers can set for Data (on the I path) and Control (on the Q path) so that a component is obtained as described above for the DPCCH+DPDCH signal. As the third part of the constellation, points can be seen at the origin, which can be assigned to the interval between preamble and message part:

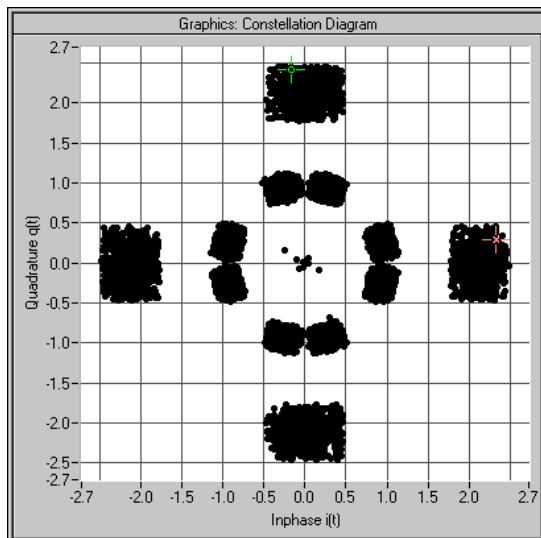

Fig. 2-144 Constellation of a PRACH

Envelopes

To eliminate smearing of the amplitude due to the root-cosine filter, all envelopes are calculated using a square-wave filter. The DPCCH and the DPDCHs are continuous channels that feature a constant envelope during the complete sequence.

Note: Section 2.14.2.6 "Misuse TPC for output power control", describes how to vary also the envelope of DPCCH and DPDCHs.

PRACH and PCPCH consist of one or several preambles and the message part. Example of a PRACH with a preamble and reduced power in the message part:

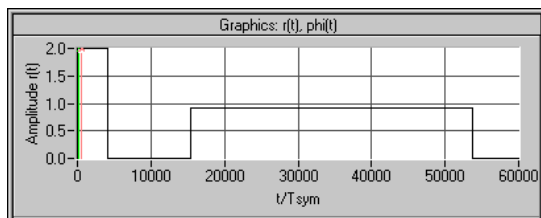

Fig. 2-145 Envelope of a PRACH

Example of a PCPCH with the parameters

- Access Slot # = 0
- Preamble Repetition = 4
- Preamble Power Step = 1 dB
- Message Part Length = 1 frame
- Preamble Power = 0 dB
- Control Part Power = 0 dB
- Data Part Power = 0 dB

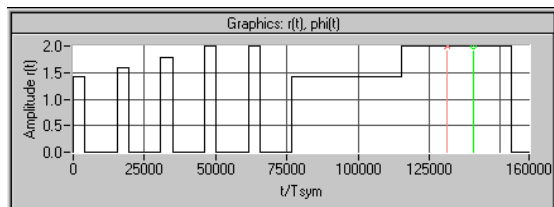

Fig. 2-146 Envelope of a PCPCH

2.14.3.2 3GPP W-CDMA Signals in the Frequency Range

For information on 3GPP W-CDMA signals in the time domain, refer to section 2.14.3.1.

The spectrum of a 3GPP W-CDMA signal (a DPCH channel) corresponds to that of a QPSK signal with identical filter parameters.

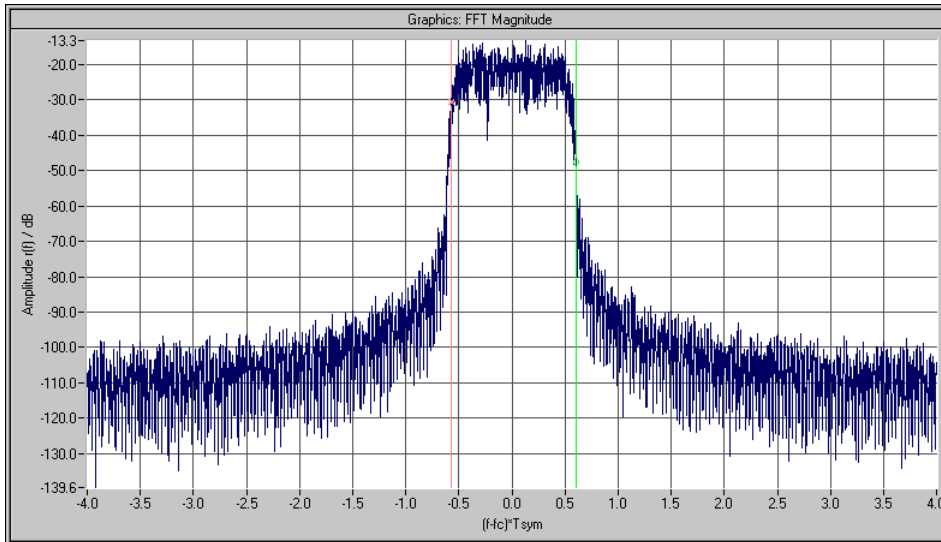

Fig. 2-147 Magnitude spectrum of a 3GPP W-CDMA signal

If signals with several channels are investigated, a certain ripple may occur in the range ± 0.5 of the chip rate.



Fig. 2-148 Magnitude spectrum (section) of a 3GPP W-CDMA signal with several channels

This effect can be influenced by the choice of the channelization codes and is reduced with increasing period of observation, i.e. higher averaging for the FFT settings.

2.14.3.3 Effect of Data Source on the 3GPP W-CDMA Signal

The choice of the data sources is of vital importance for the signal characteristics. Especially the constellation diagram and the crest factor can be modelled to a large extent by an appropriate data selection.

Since the number of channels can be very high, particularly in the downlink, this section deals only with the simulation of downlink signals.

In the following it is assumed that all channels are generated with the same scrambling code sequences and the same channel powers of 0.0 dB.

A symbol rate of 60 ksps is selected.

2.14.3.3.1 Two DPCHs with Uncorrelated Data

If the two channels are uncorrelated (data source PRBS with active option Different start values for PRBS), the resulting constellation diagram is obtained from the superposition of the constellations of two separate signals (see Fig. 2-102).

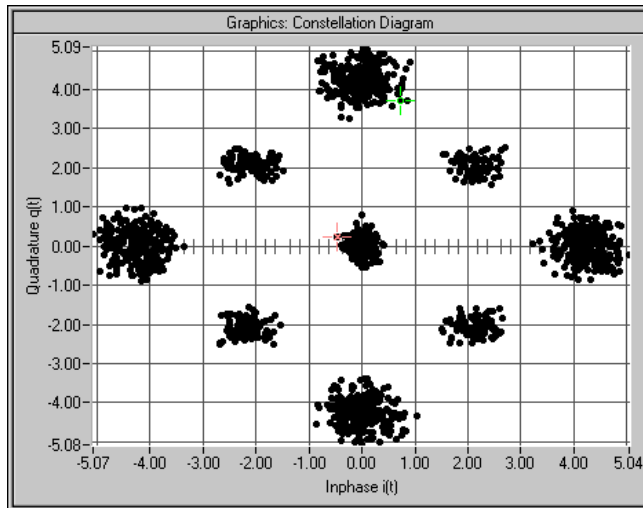

Fig. 2-149 Constellation of a signal with two DPCHs (uncorrelated data)

The resulting crest factor is 8.07 dB.

2.14.3.3.2 Two DPCHs with Same Data

If the two channels contain exactly the same data (PRBS data source with equal initial values), the individual components only differ in the channelization codes. Comparing any two lines of the channelization code matrix shows that 50% of the bits are identical and 50% are different (orthogonal matrix)). Where the bits are identical, the two channels furnish the same components; where the bits are different, the components cancel each other. The I/Q signal of this sum signal would then have the following characteristic:

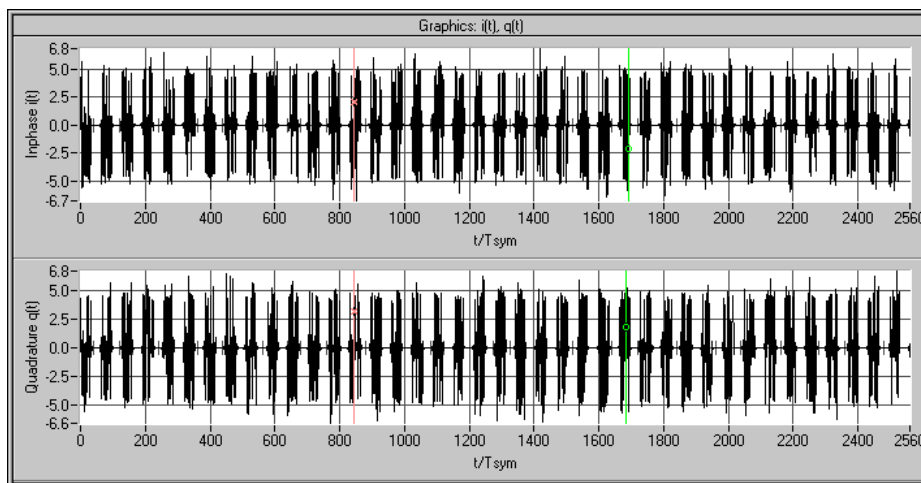

Fig. 2-150 Signal with two DPCHs (same data) in time domain

Note: The bursts occurring at regular intervals are due to the use of the channelization code numbers 0 and 1. The two lines of the matrix are identical in the first half and different in the second half. Therefore, each of the 40 source symbols causes one of these bursts, the period of which is equivalent to half the symbol length. Other combinations of channelization code numbers often cause erratic results.

The following associated constellation diagram is obtained:

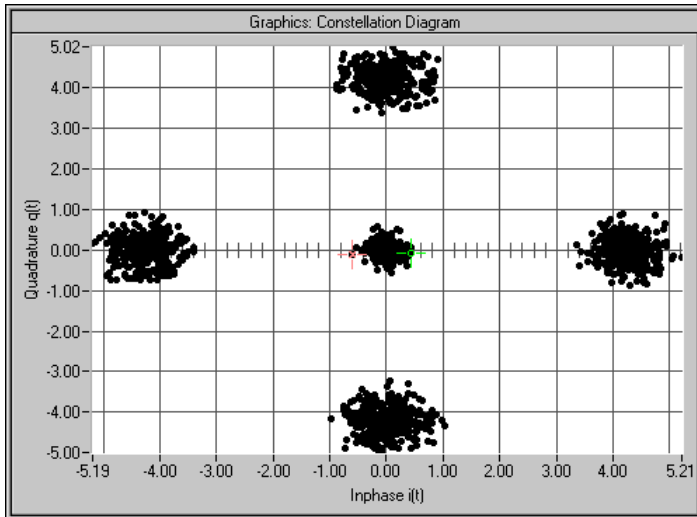

Fig. 2-151 Constellation of a signal with two DPCHs (uncorrelated data)

The new crest factor is 7.64 dB. Compared to section 2.14.3.1 the value has decreased since with constant peak value the average value has increased.

2.14.3.3.3 16 DPCHs with Uncorrelated Data

If the data of all channels are uncorrelated, the constellation diagram is obtained similarly to section 2.14.3.3 by multiple superposition of the basic constellation. Whether all possible points (channel number+1)² = 17*17 = 289 will be displayed depends on the data sequences and the sequence length.

Note: In contrast to the last constellation diagrams, the following diagrams were recorded with active receiver filter (root cosine 0.22). This allows better differentiation of the individual points. Setting of the receiver filter is described in section 5.17.

Example for 16 time slots:

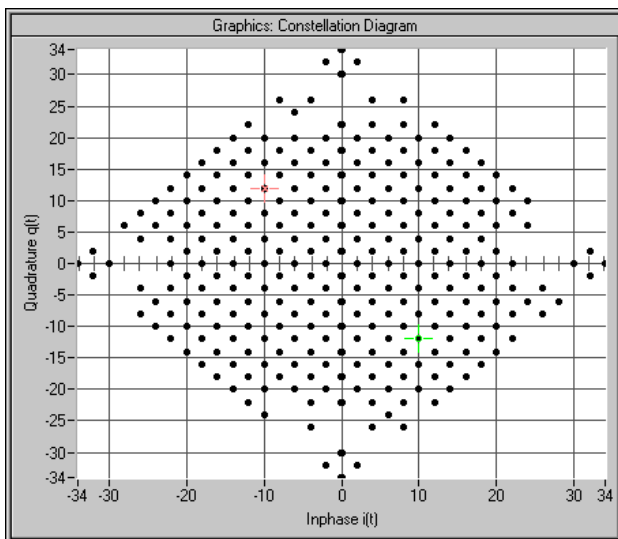

Fig. 2-152 Constellation with 16 uncorrelated channels (16 time slots)

This signal has a crest factor of 15.35 dB. The crest factor increases with the number of channels since the increase of the average value is slower than that of the peak value (cancelling effects).

The same diagram for a signal with one slot only is obtained:

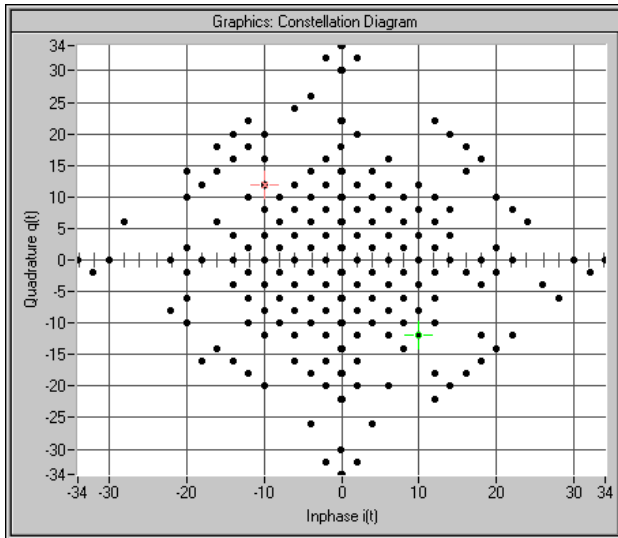

Fig. 2-153 Constellation with 16 uncorrelated channels (1 time slot)

The crest factor has the value of 15.35 dB even if the CCDF has a different characteristic.

2.14.3.3.4 16 DPCHs with same Data

Similar to section 2.14.3.3.2 there are strong cancellation effects and only points remain on the axes. The position of the points also depends on the choice of the channelization codes. The following diagram is an example for 16 channels, channelization code 0 to 15:

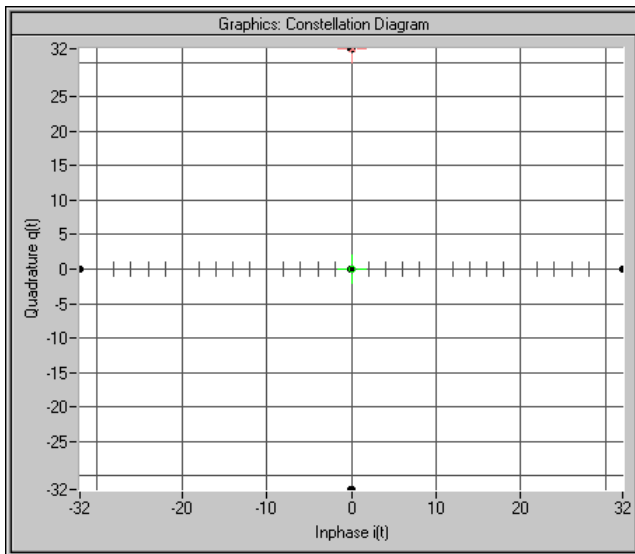

Fig. 2-154 Constellation diagram of 16 DPCHs with same data

In this case the crest factor is 16.17 dB. The high value arises because about 94 % of the points lie at the origin and only 6% of the points at the outer positions.

2.14.3.3.5 Use of Timing Offset

All previous scenarios did not use a timing offset. Therefore all channels contained the same bits at least in the pilot symbol part. The result of this special feature was that the 4 corner points (0, 2*number of channels), (0, -2*number of channels), (2*number of channels, 0), (-2*number of channels, 0) were always there (constructive superposition).

Through the use of a timing offset (in our example 1 unit (=256 chips) from channel to channel) the data bits (including pilot and TPC) are shifted against each other.

Note: *In contrast to earlier versions of the W-CDMA standard or WinIQSIM, the timing offset (previously "data offset") is no longer defined in symbols but in units of 256 chips. Thus shifting becomes independent of the spreading factor.*

The worst case is thus eliminated, the crest factor becomes smaller and the spread symbols are arranged as follows:

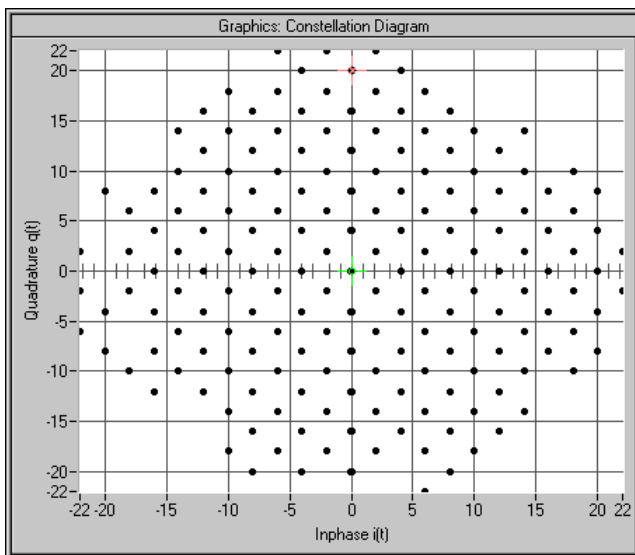

Fig. 2-155 Constellation diagram of 16 DPCHs with timing offset

Through the use of the timing offset the crest factor was reduced by approx. 4 dB to 12.26 dB.

The effect of the timing offset increases with the number of channels. If for instance 64 channels are used, the crest factor is reduced from 18.57 dB to 12.28 dB.

2.14.3.4 Effects on Crest Factor

The crest factor of the signal is mainly influenced by the following parameters:

- Link direction
By modifying the Q component of the scrambling code in the uplink, it is possible to avoid every second zero crossing. In contrast to the downlink, the crest factor is reduced by approx. 1.8 dB. (Standard case DPCCH + 1DPDCH, the effect decreases with increasing number of channels.)
- Timing offset (see 2.14.3.3.5)
In the case of more than 10 channels, an increment of 1 (i.e. the first channel is assigned 0, the second 1, etc.) causes a low crest factor. With a small number of channels, an increment of 3 or 5 permits to obtain even better values.
- Sequence length if timing offset is active
Longer sequences cause higher peak values and hence higher crest factors since the probability of even higher peak values increases.
- Number of channels
More channels cause higher crest factors.
- Selection of channelization codes
Neighbouring channelization codes usually cause higher crest factors than numbers distributed over the full range of available values.
- **Example:** 16 channels with channelization codes 0 to 15: 16.7 dB
16 channels with channelization codes 0, 4, 8, to 60: 12,45 dB
- Value of clipping level (see section 2.14.2.10)

2.14.3.5 Orthogonality of Channels

To enable a 3GPP W-CDMA demodulator to restore the information of the individual channels from the sum signal, only certain combinations of

- scrambling code sequences,
- channel power and
- symbol rate and channelization codes

are allowed.

2.14.3.5.1 Ideal Scenario

In an ideal scenario the measured channel power (with code domain power analyzers) is equal to the transmitted power (setting value in the channel configuration table), Even with great differences between the channel powers the information of the channels can be restored 100%. For this purpose however orthogonality of the channels is required. Orthogonality is given in all cases described in section 2.14.3.3 Orthogonality is given for instance if DPCH channels are used only and all of them have the same symbol rate but different channelization codes. In addition, identical scrambling code values have to be set for all channels, i.e. all channels have to belong to a base station.

In this case the bit streams SC_i and SC_q are identical for all channels. Since the channelization code sequences of two channels are orthogonal, the chip sequences S_i and S_q of two channels are also orthogonal.

2.14.3.5.2 Real Scenario

A real scenario usually consist of signals from different base/mobile stations that are operated at different scrambling codes and have different delays. In this case there is no orthogonality, the channel powers overlap and the bit error rates increase with decreasing channel power (therefore power control is extremely important for all CDMA systems).

2.14.3.5.3 Effect of SCH

The SCH is not orthogonal to the DPCHs and all other downlink channels since the synchronization code symbol is spread according to a special scheme (see section 2.14.1.1, System Components).

In the following example, the channels P-SCH, S-SCH, CPICH, P-CCPCH and two DPCHs (15 kbps to code 7 and 12) are included. If the SCH is compensated with the code domain power analysis, the channel powers can be determined ideally:

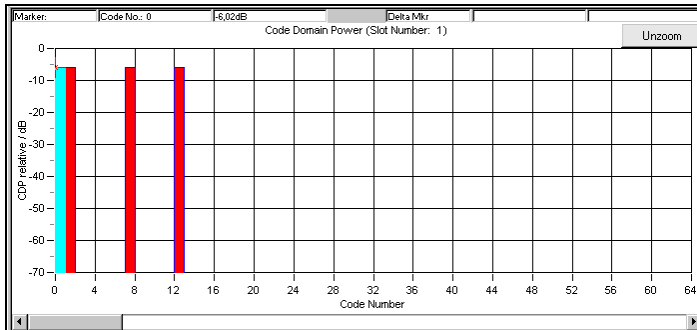

Fig. 2-156 CDPA of a signal with compensated SCH

If the SCH is not compensated, crosstalk to the other channels can be clearly seen:

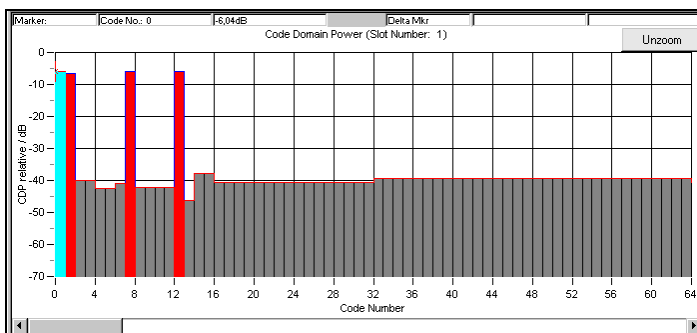

Fig. 2-157 Effect of SCH on CDP analysis (without compensation)

The transmitted channels are measured with an error of <math><0.2\text{ dB}</math>. For all other channels a power of approx. -40 dB is determined.

These conditions still allow error-free decoding of all transmitted channels.

2.14.3.5.4 Effect of S-CCPCH and the Other Downlink Channels

Like a DPCH, S-CCPCH, P-CPICH, S-CPICH, PDSCH, PICH, AICH and DL-DPCCH are spread with the same symbol rate. Therefore the same conditions as for DPCHs apply to the parameters of these channels (see section 2.14.3.5.7).

2.14.3.5.5 Effect of PRACH and PCPCH

The PRACH and the PCPCH are not orthogonal to DPCHs and DPDCHs since the scrambling code is formed differently. Mobile stations never use PRACH or PCPCH and DPCH/DPDCH simultaneously – therefore mixed operation is only possible in WinIQSIM if these channel types are distributed to different stations (e.g. MS1 and MS2).

2.14.3.5.6 Effect of Scrambling Code

The scrambling code permits to distinguish between base stations (downlink) and mobile stations (uplink). If different scrambling codes are used within a signal (in this example, the scenario under section 2.14.3.5.3 is coded twice with different scrambling codes), the orthogonality between the channels will be lost.

The following example shows the level conditions measured after despreading:

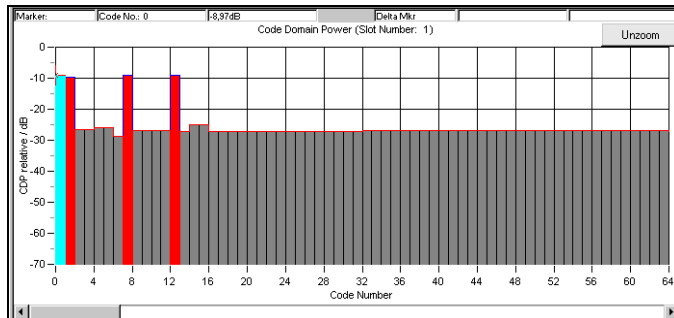

Fig. 2-158 Effect of different scrambling codes on the power distribution

These conditions still allow error-free reconstruction of the bit streams. A certain guard interval should however always be observed between the transmitted channel power and the measured power of the other (non-orthogonal) channels.

In this example a channel power of -10 dB is sufficient for error-free decoding, whereas with a power of -15 dB the bit error rate is about 10 % already. (The given values were evaluated at the physical layer using a CDPA. Even under worse conditions error-free reconstruction of the bit stream can be made through channel coding!)

2.14.3.5.7 Effect of Symbol Rates and Channelization Code Numbers

The channelization code generation method has the effect that with certain symbol rate/channelization code combinations the identical spreading sequences S_i/S_q are generated. This is always the case with channelization code number 0 (all bits 0), but also with the combination 960 ksp/s/channelization code 1 (0011) <-> 480 ksp/s/channelization code 2 (00110011).

As a rule, the spreading sequences are identical if the products of symbol rate and channelization code are identical.

The despreader can therefore no longer differentiate between the two channels. Depending on the data contents, the channel powers are either added up or cancel each other. Restoring of all source data is not possible.

The following signal contains

- a DPCH with 960 ksp/s, channelization code number 1, 0 dB, data all 0
- a DPCH with 480 ksp/s, channelization code number 2, 0 dB, data all 1

An analysis at 960 ksp/s gives the following result:

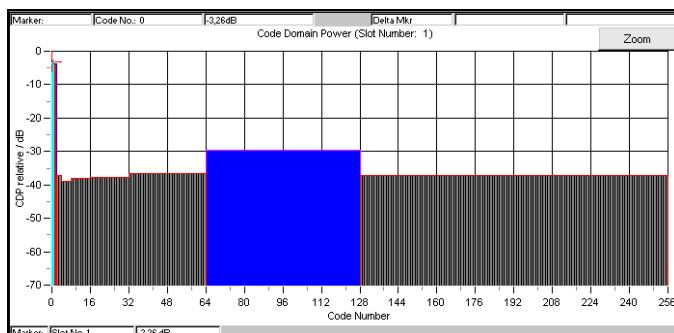

Fig. 2-159 Cancellation possible in case of several channels with identical spreading sequences

Apart from this trivial case there are other cases in which problems may occur.

The above example is modified by changing the channelization code of the second DPCH from 2 to 3:

- a DPCH with 960 ksps, channelization code 1, 0 dB, data all 0
- a DPCH with 480 ksps, channelization code 3, 0 dB, data all 1

After despreading at symbol rate 480 ksps, the following power distribution is obtained:

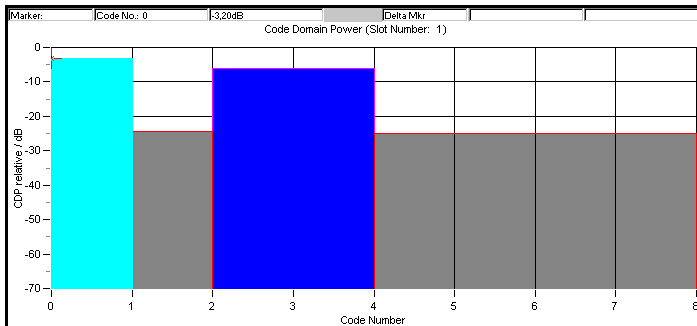

Fig. 2-160 Incorrect detection at various symbol rates

The 960-ksps channel (channelization code 1) is detected as channel 2 at 480 ksps. There is however no crosstalk to channel 3. Therefore the 480-ksps channel is detected with the original power and all bits can be restored.

Despreading of the 960-ksps channel however gives the following power distribution:

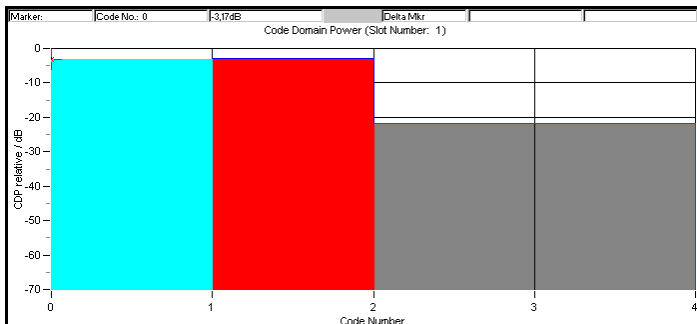

Fig. 2-161 Non-restorable DPCH channel

Both channels synchronize with channel 1, despreading is no longer possible with these level conditions.

For despreading all transmitted DPCHs, two channels of half the symbol rate (channelization codes $2n$, $2n+1$) should therefore be avoided for each channel used with a certain symbol rate (channelization code n). This is continued for four channels of one fourth of the symbol rate (channelization codes $4n$, $4n+1$, $4n+2$, $4n+3$), etc.

For further information refer to section 2.14.2.9.

2.14.3.6 Simulation of Special Scenarios

It is shown in the following how special scenarios can be simulated by means of WinIQSIM parameters. The downlink is used as an example, since a mobile station can always be completely implemented in an MS. Scenario for the simulation of several base stations 2.14.3.6.4 can also be applied to the simulation of mobile station signals.

Note: Section 2.14.2.2 describes a particularly simple method for setting a base station.

2.14.3.6.1 Standard Base Station

A standard base station is the easiest example of a base station.

- Activate the channels P-CPICH, P-SCH, S-SCH and P-CCPCH (State = ON). These channels are absolutely necessary for the synchronization of a mobile station with the signal.
- Activate between 0 and 128 DPCHs.
- Select channelization codes and symbol rates so that no code domain conflicts occur.
- Use timing offset in channels to model the offsets T_{DPCH} , T_{PICH} , $T_{S-CCPCH}$ ([1], section 7) as specified in the 3GPP W-CDMA standard.
- Set a valid combination of scrambling code and 2nd Search Code Group. (For details refer to [2] 5.2.2)

In [3], Appendix D, a few test models are specified that have been designed for certain tests. These scenarios are supplied as WinIQSIM setups.

They can be found in the 3GPP W-CDMA - TEST MODELS menu.

2.14.3.6.2 Base Station with More Than 128 DPCHs

To avoid the channel table becoming ambiguous, a BS in WinIQSIM may contain a maximum of 128 DPCHs. If a base station is to be simulated with more than 128 DPCHs, these channels have to be distributed to several BS.

- Make the same settings as in section 2.14.3.6.1 for the first BS.
- Assign the remaining DPCHs to the other BSs.
- Select the channelization codes and symbol rates so that no code domain conflicts occur, even beyond the limits of a BS.

Note: The SMIQ does not support code domain power (conflict) display beyond the limits of a MS/BS. If several stations are available it is useful to divide the available range in subranges (e.g. BS1 : 0 to 256, BS2 : 257 to 467, BS3: 468 to 511).

- Set the same value and type for the scrambling code for all BSs.

Note: The function "Copy BS/MS", as described in section 2.14.3.6.1 facilitates the transfer of these values from one BS to another.

2.14.3.6.3 Base Stations with Spreading Codes Used Several Times

3GPP W-CDMA envisages an increase in the number of channels using primary and secondary scrambling codes. The PCCPCH and the first part of DPCHs is then sent with the primary scrambling code, the remaining DPCHs with one of the assigned secondary scrambling codes. The following range of values is given in [2]:

Primary scrambling code : $n = 16 * i$ with $i=0$ to 511

Secondary scrambling code : $n = 16 * i + k$ with $i=0$ to 511 and $k=1$ to 15

Note: *The use of secondary scrambling codes principally yields the same results as the parameter T_{offset} specified in former standards.*

When the secondary scrambling codes are used, orthogonality is impaired and a crosstalk is produced (see section 2.14.3.5.6).

This scrambling code can be entered for a BS. If channels with different scrambling codes are to be simulated, a division into several BSs is required as described under 2.14.3.6.2:

- Set several BSs according to 2.14.3.6.1. The special channels (SCH, CPICH, ...) will be activated in one BS only.
- Set the desired values for the scrambling code for all BSs.

2.14.3.6.4 Several Base Stations

3GPP W-CDMA base stations can be at different RF frequencies. This case can be simulated in WinIQSIM using the multicarrier mixed signal system and option SMIQB60.

Since there are normally not enough frequencies available, the base stations within a transmit frequency are distinguished by the primary scrambling code.

- Set several BSs according to 2.14.3.6.1.
- Set the desired values for the scrambling code for all BSs.

2.15 Enhanced Functions For Digital Standard 3GPP W-CDMA (FDD)

Option SMIQB48 expands the scope of functions of option SMIQB45 and offers the following features:

- Sequences with a length of up to 2044 frames (SMIQB45: 13 frames)
- Data lists for data fields and TPC
- External control of channel power in real time
- Channel coding
- Insertion of bit errors (for testing a BER tester)
- Insertion of block errors (for testing a BLER tester)
- Simulation of orthogonal channel noise (OCNS)
- Simulation of up to 64 additional mobile stations
- Simulation of a channel-coded P-CCPCH (BCP) with system frame number

2.15.1 Test Setup

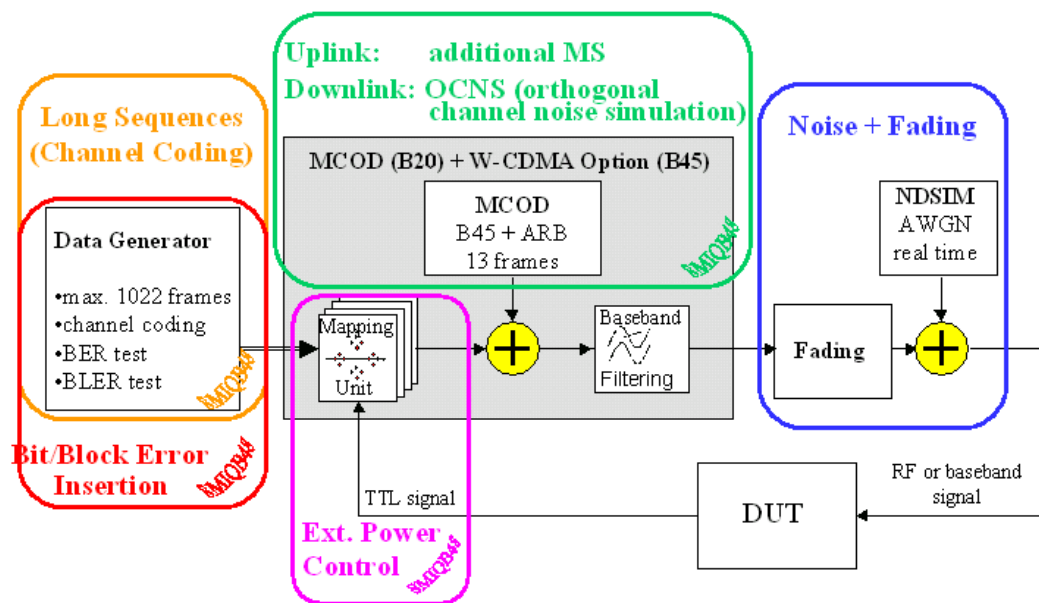

Fig. 2-163 Complete setup for testing a W-CDMA receiver with the SMIQ

This block shows the different functional blocks of the SMIQ with built-in option SMIQB48.

Blocks "Long Sequences/Channel Coding", "Bit/Block Error Insertion", "OCNS" and "External Power Control" are part of option SMIQB48 and will be described in detail.

"Noise" is available only if option SMIQB17 is built-in. For a description see section "Noise Generator and Distortion Simulator".

To simulate "Fading", option SMIQB14/SMIQB15 or SMIQB49 is required. This option is described in the section on "Fading Simulation".

References:

- [1] 3GPP TS25.101 V4.1.0 UE Radio transmission and reception (FDD)
- [2] 3GPP TS25.212 V4.1.0 Multiplexing and channel coding (FDD)
- [3] 3GPP TS25.104 V4.1.0 BS Radio transmission and reception (FDD)
- [4] 3GPP TS25.141 V4.1.0 Base Stations Conformance Testing (FDD)
- [5] 3GPP TS25.944 V4.1.0 Channel Coding and multiplexing examples
- [6] 3GPP TS25.331 V4.1.0 RRC Protocol Specification

2.15.2 Branching to Menus SMIQB48 of Digital Standard 3GPP WCDMA

The enhanced functions of option SMIQB48 are directly accessible from the menu of option SMIQB45, i.e. the digital standard WCDMA/3GPP must be selected. This section only describes the parameters and functions that are directly available with option SMIQB48 installed and which have not been described in the sections "Digital Standard 3GPP W-CDMA" and "Generation of 3GPP W-CDMA Signals".

FREQ 2.000 000 000 0 GHz		LEVEL -30.1 dBm	
		PEP -20.0 dBm	
WCDMA/3GPP		ALC-S&H	
FREQUENCY	PHS IS95	FILTER...	WCDMA 0.22
LEVEL	WCDMA	Assistant/Enhanced Functions	
ANALOG MOD	WCDMA/3GPP	PARA.PREDEF SETTING...	
VECTOR MOD	NADC	ENHANCED CHANNELS BS1/MS1... OFF	
DIGITAL MOD	PDC	OCNS CHANNELS...	
DIGITAL STD	GSM/EDGE	Graphics	
ARB MOD	DECT	CCDF ▶	
BERT		SELECT BS/MS	
LF OUTPUT		BS 1	BS 2
SWEEP		ON	OFF
LIST		BS 3	BS 4
		OFF	OFF

Fig. 2-164 Menu DIGITAL STD – WCDMA/3GPP – Section Assistant/Enhanced Functions (downlink)

FREQ 2.000 000 000 0 GHz		LEVEL -30.1 dBm	
		PEP -26.9 dBm	
WCDMA/3GPP		ALC-S&H	
FREQUENCY	PHS IS95	FILTER...	WCDMA 0.22
LEVEL	WCDMA	Assistant/Enhanced Functions	
ANALOG MOD	WCDMA/3GPP	ENHANCED CHANNELS BS1/MS1... OFF	
VECTOR MOD	NADC	ADDITIONAL MS BASED ON MS4... OFF	
DIGITAL MOD	PDC	Graphics	
DIGITAL STD	GSM/EDGE	CCDF ▶	
ARB MOD	DECT	CCDF TRACES	
BERT		3	
LF OUTPUT		SELECT BS/MS	
SWEEP		MS 1	MS 2
LIST		ON	OFF
		MS 3	MS 4
		OFF	OFF

Fig. 2-165 Menu DIGITAL STD – WCDMA/3GPP – Section Assistant/Enhanced Functions (uplink)

-----Assistant/Enhanced Functions-----

ENHANCED CHANNELS BS1/MS1 Call-up of user menu for configuring the enhanced channels. The menu item is only available with option SMIQB48 installed. For more detailed information regarding this menu see section 2.15.3

OCNS CHANNELS Simulation of orthogonal channel noise. The menu item is only available in the downlink with option SMIQB48 installed. For more detailed information regarding this menu see section 2.15.4.

ADDITIONAL MS BASED ON MS4 Simulation of up to 50 additional mobile stations. The menu item is only available in the uplink and with option SMIQB48 installed. For more detailed information regarding this menu see section 2.15.5.

2.15.3 Enhanced Channels BS1/MS1

Enhanced Channels are channels which – in contrast to option SMIQB45 – are neither calculated nor generated on the modulation coder but on the data generator. Up to four enhanced channels (or seven with uplink mode) are possible where the maximum sequence length is calculated from the free list memory and the number of channels:

Downlink:

$$\text{Sequence_Length/ Frames} = \frac{\text{Available_Data_List_Memory/ Bits}}{\text{Number_Of_Enhanced_Channels} * 2 * 38400}$$

With maximum memory capacity, there are thus between 255 (4 DPCH) and 1022 (1 DPCH) frames.

In the downlink (possibly depending on memory capacity), a P-CCPCH/BCH with a continuous system frame number (period 4096 frames) can also be generated at the same time as a DPCH (period 2044 frames) with a max physical rate of 30 ksps.

The simulation of higher rate channels (>30 ksps) together with the P-CCPCH/BCH is also supported however with a reduced maximum sequence length of 500 frames.

(For a systematic list of all possible sequence lengths see description of SEQUENCE LENGTH parameter, section **Fehler! Verweisquelle konnte nicht gefunden werden.**).

Note: This sequence length is sufficient for all performance tests in [1], section 8, since in these tests the block error rate is measured.

Uplink:

$$\text{Sequence_Length/ Frames} = \frac{\text{Available_Data_List_Memory/ Bits}}{(\text{Number_Of_Enhanced_Channels} + 1) * 38400}$$

With maximum memory capacity, there are thus between 255 (DPCCH + 6 DPDCH) and 1022 (1 DPCCH or 1 DPDCH) frames.

Note: The higher number of channels in the uplink is possible through the BPSK data modulation.

These long sequences allow a physical **BER measurement (PN9) without a restart** of the BER tester being required. An enhanced channel with a length of 511 frames is to be set.

If the maximum length of 1022 frames is used, BER measurements with channel coding and without restart as required for receiver tests to [1], [3], [4] are possible.

Compared to the clearly enhanced sequence length range (max. 13 frames for SMIQB45), option SMIQB48 offers the following advantages:

After generation of the sequence in the data generator **Data lists are available as data sources** for the data fields and the TPC fields. Externally precoded data can be loaded into the SMIQ by the user, for example to implement channel-coding schemes that are not supported by option SMIQB48. Analogously, the long TPC lists are necessary to generate long non-repetitive power profiles.

Moreover, a base station can be simulated, which comprises a channel-coded P-CCPCH (BCH) and a 12.2 kbps reference measurement channel in addition to background and synchronization channels. The system frame number (SFN) in BCH is automatically incremented in steps of two from 0 to 4094 (period 4096). The remaining system information of BCH can be filled from data lists, for example.

Another feature of enhanced channels is the possibility to generate the **reference measurement channels** described in [1], [3] and [4] and the AMR channels described in [5]. For a description see 2.15.3.1.1.

The chip sequences of the enhanced channels are transmitted in binary form to the modulation coder and are converted into (initially digital) I/Q levels in a mapper. This mapping can be switched by an external input line (TTL, connected to LEVATT (PARDATA pin 9 or SMIQ-Z5)). The **channel powers of the enhanced channels can be controlled in real time**, allowing the test of "SIR based closed loop power control", for example. For further information see 2.15.3.1.3.

For testing BER/BLER testers (e.g. integrated into base station), artificial **bit errors (or block errors into the CRC checksum) can be integrated** in all data sources. The required parameters can be found in section 2.15.3.1.5

The menu structure depends on the link direction. Since there are only slight differences, first the downlink and all common parameters are described in section 2.15.3.2 and then all uplink parameters.

2.15.3.1 Downlink

FREQ	2.000 000 000 0 GHz			LEVEL	-30.1 dBm
				PEP	-20.0 dBm
WCDMA/3GPP				ALC-S&H	
FREQ	ENHANCED CHANNELS STATE			OFF	ON
LEVEL	Channel Coding				
ANALC	CHANNEL CODING STATE			OFF	ON
VECTC	CODING TYPE			MEASURE	12.2
DIGIT	INTERLEAVER 1			OFF	ON
DIGIT	INTERLEAVER 2			OFF	ON
ARB M	Bit Error Insertion				
BERT	INSERT BIT ERRORS IN DATA			OFF	ON
LF OU	NOMINAL BIT ERROR RATE			1.000 0 E-03	
SWEEP	RESULTING BIT ERROR RATE DPCH			0 E-09	
LIST	RESULTING BIT ERROR RATE DTCH			0 E-09	
	RESULTING BIT ERROR RATE DCCH			0 E-09	
	INSERT BLOCK ERRORS			OFF	ON
	NOMINAL BLOCK ERROR RATE			1.000 0 E-03	
	RESULTING BLOCK ERROR RATE DTCH			0 E-09	
	RESULTING BLOCK ERROR RATE DCCH			0 E-09	
	External Power Control				
	EXTERNAL POWER CONTROL STATE			OFF	ON
	POWER STEP			1.00 dB	
	POWER UP RANGE			10.0 dB	
	POWER DOWN RANGE			10.0 dB	
	Common Enhanced Channels Settings				
	SEQUENCE LENGTH	CURRENT MAX: 1 042 Frame		1 Frame	
	SYMBOL RATE DPCH...			15 ksp/s	
	TIMING OFFSET DPCH			0	
	PILOT LENGTH DPCH...			4	
	Specific Enhanced Channels Settings				
	CHANNEL NUMBER	11	12	13	14
	STATE	ON	OFF	OFF	OFF
	TYPE	DPCH	DPCH	DPCH	DPCH
	CHAN CODE	0	0	0	0
	POWER START	0.0	0.0	0.0	0.0
	POWER CONTROL	OFF	OFF	OFF	OFF
	DATA	PN15	PN15	PN15	PN15
	DATA DTCH	PN15	PN15	PN15	PN15
	DATA DCCH	PN15	PN15	PN15	PN15
	TPC	PATT	PATT	PATT	PATT
	MULTI CODE	OFF	OFF	OFF	OFF
	CHANGE DATA				
	SELECT DATA LIST...			CURRENT: DLIST00	
	COPY CURRENT DATA LIST TO...				
	DELETE DATA LIST...				
	EDIT DATA LIST...				

Fig. 2-166 Menu DIGITAL STD-WCDMA/3GPP-ENHANCED CHANNEL (downlink)

ENHANCED CHANNELS STATE

Switch for activating or deactivating the calculation of up to 4 enhanced channels on DGEN.

In the OFF state, all the following menu parameters no longer influence the 3GPP W-CDMA signal which is only calculated in MCOD ARB.

IEC/IEEE-bus command : SOUR:W3GP:BST:ENH:STAT ON

2.15.3.1.1 P-CCPCH/BCH with System Frame Number

In addition to channel-coded reference measurement channels, test specifications for mobile or UE tests (see [1]) often stipulate a channel-coded P-CCPCH (BCH). With the Enhanced P-CCHCP/BCH State activated, the SMIQ can generate this test scenario.

The SMIQ then offers one P-CCPCH and one DPCH instead of the 4 enhanced DPCHs in the Standard Enhanced mode (Enhanced P-CCHCP/BCH State Off).

ENHANCED P-CCPCH/BCH (INCL. SFN) STATE This switch enables one P-CCPCH/BCH and one DPCH to be generated as enhanced channels (OFF) instead of the 4 DPCHs.
IEC/IEEE-bus command : SOUR:W3GP:BST:ENH:PCCP:STAT ON

With Enhanced P-CCHCP/BCH State On, this may affect the structure of the other operating menus:

- The channel table under **Specific Enhanced Channel Settings** contains the P-CCPCH and a DPCH.
- If the P-CCPCH is activated under **Specific Enhanced Channel Settings**, it will automatically be generated with the sequence length 4096 frames (SFN period).
- The maximum sequence length (SEQUENCE LENGTH DPCH) changes:
 - for symbol rates ≤ 30 ksps: 2044 frames
 - for symbol rates >30 ksps: 500 frames

FREQ 2.000 000 000 0 GHz		LEVEL 0.0 dBm
		PEP +9.7 dBm
WCDMA/3GPP		ALC-ON
MISUS	POWER UP RANGE	10.0 dB
POWER	POWER DOWN RANGE	10.0 dB
TRANS Common Enhanced Channels Settings		
NUMBE	SEQUENCE LENGTH P-CCPCH/BCH	4 096 Frame
MULTI	SEQUENCE LENGTH DPCH	CURRENT MAX: 1 042 Frame
ENHAN	SYMBOL RATE DPCH...	15 ksps
CODE	TIMING OFFSET DPCH	0
CHANN	PILOT LENGTH DPCH...	4
-CHNO- Specific Enhanced Channels Settings		
0	CHANNEL NUMBER	4 11
1	STATE	ON ON

Fig. 2-167 Common Enhanced Channel Settings with Enhanced P-CCHCP/BCH State On

FREQ 2.000 000 000 0 GHz		LEVEL 0.0 dBm
		PEP +9.7 dBm
WCDMA/3GPP		ALC-ON
MISUS	PILOT LENGTH DPCH...	4
POWER Specific Enhanced Channels Settings		
TRANS	CHANNEL NUMBER	4 11
NUMBE	STATE	ON ON
MULTI	TYPE	P-CCPCH DPCH
ENHAN	CHAN CODE	1 0
CODE	POWER START	0.0 0.0
CHANN	POWER CONTROL	OFF
-CHNO-	DATA	PN15 PN15
0		
1	TPC	PATT

Fig. 2-168 Specific Enhanced Channel Settings with Enhanced P-CCHCP/BCH State On

Generation principle of channel-coded P-CCPCH with system frame number

With Enhanced P-CCHCP/BCH State On, channel coding activated (Channel Coding State On) and with P-CCPCH State under Specific Enhanced Channel Settings On, the SMIQ generates a channel-coded P-CCPCH (i.e. a broadcast channel BCH) according to the following principle:

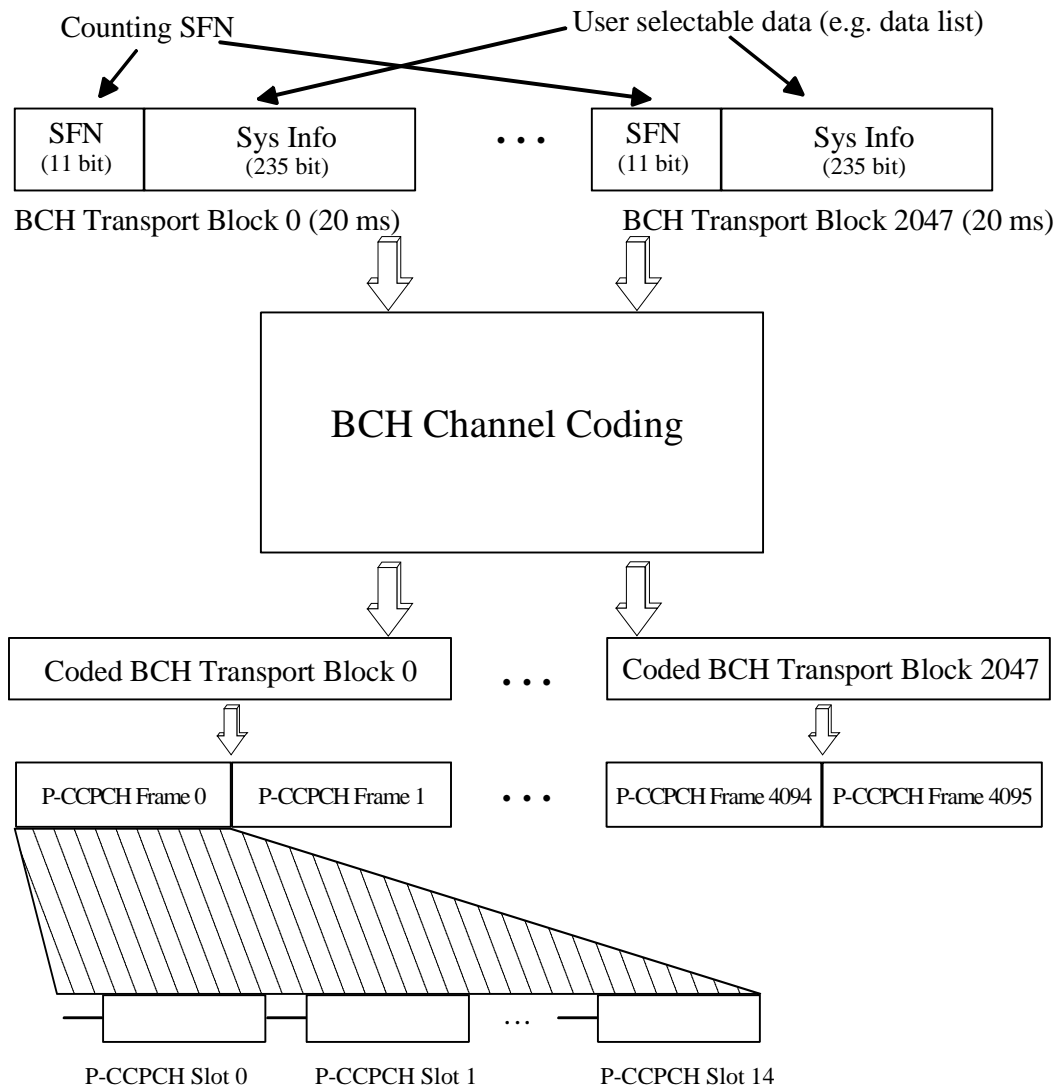

Fig. 2-169 Generation principle P-CCPCH/BCH

The data blocks of BCH at transport-channel level comprise data determined for 20 ms of the P-CCPCH (i.e. 2 frames) after channel coding. The first field of such a data block is an 11-bit long field for the system frame number (SFN). The SFN is automatically incremented by 1 (as stipulated in the standard) from transport block to transport block (equivalent to a step width of 2 frames due to the transport time interval length of 20 ms). After 2048 transport blocks (equivalent to 4096 frames) SFN is reset and starts again at 0 (SFN restart). An output trigger indicating the SFN restart can be generated (see 2.14.2.1).

The SFN format is defined in [6], sections 10.2.48, 11.2 (page 578) and 11.3 (page 691). It is MSB-first coded.

The remaining system information (a 235-bit long field per block) is filled from the data source selected for the P-CCPCH under Specific Enhanced Channel Settings.

A data list can be used to transmit further specific system information in addition to the SFN. If only the SFN is required, **ALL 0** is recommended as data source for P-CCPCH.

The BCH transport blocks are then channel-coded. A coded transport block comprises the data sequence for two P-CCPCH frames.

2.15.3.1.2 Channel Coding

Many tests can be found in [1] and [3] all of which require channel-coded measurement channels, so-called Reference Measurement Channels. Types 12.2 kbps, 64 kbps, 144 kbps and 384 kbps are indicated for each link direction.

In addition, the SMIQ can simulate an AMR voice channel according to [5]. The detailed structure of these channels is described in the following documents:

Table 2-27 References to measurement channels

CODING TYPE	Reference downlink	Reference uplink
MEASURE__12.2	[1], A.3.1	[3], A.2 and [4], A.2
MEASURE__64	[1], A.3.2	[3], A.3 and [4], A.3
MEASURE_144	[1], A.3.3	[3], A.4 and [4], A.4
MEASURE_384	[1], A.3.5	[3], A.5 and [4], A.5
AMR_CODER	[5], 4.1.1.3.1.2	[5], 4.1.2.2.1.2

To simplify the implementation of channel decoding in the test receiver the two interleaver stages in the measurement channels can separately be switched on and off.

-----Channel Coding-----

CHANNEL CODING STATE

Switch for activating or deactivating the channel coding of all enhanced channels.

In the OFF state, the following menu parameters are not effective:

CODING TYPE,
INTERLEAVER 1,
INTERLEAVER 2,
CODING (enhanced channel specific).

IEC/IEEE-bus command : SOUR:W3GP:BST:ENH:CCOD ON

CODING TYPE

Setting the channel coding type of all enhanced channels.

The 3GPP specification currently stipulates 4 predefined MEASUREMENT channel coding types which differ in the input data bit rate to be processed (12.2, 64, 144 and 384 KBPS). The additional AMR_CODER coding scheme generates the coding of a speech channel.

For channel coding, the input data bits are taken from the data source specified in menu parameter DATA. The bits with a higher data rate are available at the output of channel coding. There are fixed assignments between the measurement input data bit rate and the output symbol rate, i.e. the menu parameters SYMBOL RATE DPCH (Downlink) or OVERALL SYMBOL RATE are adapted automatically.

MEASURE_12.2 Measurement channel 12.2 kbps

MEASURE_64 Measurement channel 64 kbps

MEASURE_144 Measurement channel 144 kbps

MEASURE_384 Measurement channel 384 kbps

AMR_CODER Channel coding for AMR Coder

IEC/IEEE-bus command : SOUR:W3GP:BST:ENH:CCOD:TYP M12K

INTERLEAVER 1,2

Switch for separately activating or deactivating channel coding interleaver stages 1 and 2 of all enhanced channels. (The interleaver stages do not change the symbol rate.)

IEC/IEEE-bus command : SOUR:W3GP:BST:ENH:CCOD:INT1 ON

2.15.3.1.3 Bit Error Insertion

Errors can be inserted in the data source or the CRC checksum for testing the bit/block error rate tester. If channel coding is inactive (CHANNEL CODING STATE = OFF), the data bits are fed into the slots at the physical level. If channel coding is active (CHANNEL CODING STATE = ON), the data bits are fed at the transport layer level. The bit errors are always generated at the data source level.

INSERT BIT ERRORS IN DATA Switch used to activate or deactivate the insertion of bit errors in the data fields of all active enhanced channels at the frequency indicated under the NOMINAL BIT ERROR RATE parameter.

In the OFF state, the following menu parameters NOMINAL BIT ERROR RATE and RESULTING BIT ERROR RATE are not effective.

IEC/IEEE-bus : SOUR:W3GP:BST:ENH:DERR:BIT:STAT ON

NOMINAL BIT ERROR RATE

Sets a user-defined bit error rate in the range of 10^{-1} to 10^{-7} with which the bits can be inserted into the data fields of the enhanced channel timeslots. Upon readout of the data source individual bits are inverted at random at a given error rate to simulate an erroneous signal.

Since the bit error rate set by the user may not be adhered to as a function of the frame SEQUENCE LENGTH and the selected SYMBOL RATE DPCH or OVERALL SYMBOL RATE, the actual bit error rate is displayed in the next line, i.e. RESULTING BIT ERROR RATE.

IEC/IEEE-bus : SOUR:W3GP:BST:ENH:DERR:BIT:RATE 2E-3

RESULTING BIT ERROR RATE

Parameter indicating the resulting bit error rate used to insert the bits into the data fields of the enhanced channel timeslots (see NOMINAL BIT ERROR RATE parameter).

CHANNEL CODING STATE = OFF:

The BER of DPCH is displayed here.

IEC/IEEE-bus : SOUR:W3GP:BST:ENH:DERR:BIT:DPCH?

CHANNEL CODING STATE = ON:

The BER of DTCH and DCCH is displayed here.

IEC/IEEE-bus : SOUR:W3GP:BST:ENH:DERR:BIT:DTCH?

IEC/IEEE-bus : SOUR:W3GP:BST:ENH:DERR:BIT:DCCH?

2.15.3.1.4 External Power Control

Two test constellations have to be distinguished in the test of Closed (Inner) Loop Power Control:

1. Test whether the DUT responds with the correct output power to received TPC bits (e.g. for testing according to [1], 6.4.2.1). This can be carried out by using a data list adapted to the test condition as TPC data source. The TPC pattern can be defined in the channel table (see previous section, "Menu WCDMA/3GPP - Submenu BS Configuration" or "Menu WCDMA/3GPP - Submenu MS Configuration", and also section 2.15.3.1.5).
2. Test whether the DUT correctly performs the SIR (Signal to Interference Ratio) measurement and inserts the corresponding bits into the TPC field of its transmit signal. Since the SMIQ has no receive channel, the TPC control information has to be taken to the generator via another channel. This is possible via "External Power Control".

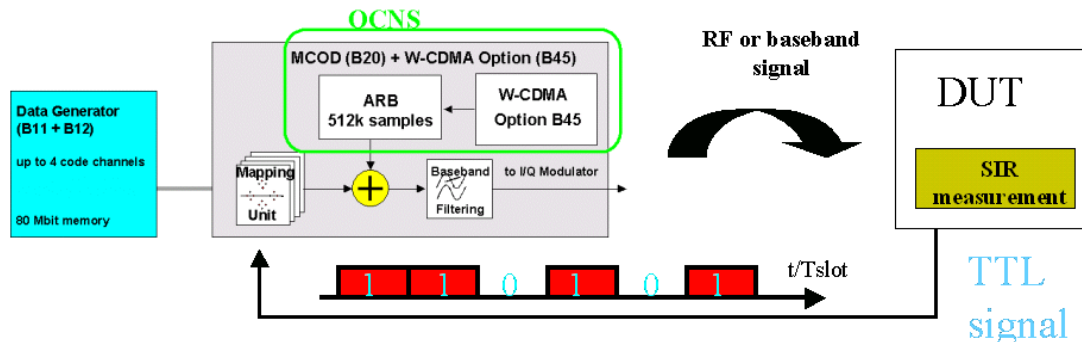

Fig. 2-170 Setup for testing Closed Loop Power Control

The power of all activated enhanced channels can be increased or decreased in a predefined dynamic range (= POWER_UP_RANGE + POWER_DOWN_RANGE) and in the defined step width (= POWER_STEP) with the TTL signal "External Power Control".

The power change of the channels is performed by a switchover of the mapping table, controlled by the external power control signal which is queried at the beginning of the pilot field. Since the number of mappings is limited, the maximum dynamic range is restricted to 30 dB and the step width to min. 0.25 dB. The output power of each channel is thus limited to the [POWER_START-POWER_DOWN_RANGE...POWER_START+POWER_UP_RANGE] range.

Note : *To obtain optimum signal quality, the POWER_UP_RANGE should not be set higher than necessary since the mapping of the I/Q level in this range must be maintained as a level margin.*

POWER_START and POWER_CONTROL = UP/DOWN can be set channel-specifically (see section 2.15.3.1.5).

In the following example it is assumed that

- POWER_UP_RANGE = POWER_DOWN_RANGE
- POWER_CONTROL = UP for channels 0, 2 and 3, POWER_CONTROL = DOWN for channel 1

Available mappings are shown at the right with MAP_M being the starting point. In this point, all channels have the power which was set in the menu as POWER_START.

At the beginning of the pilot field the LEVATT line is queried in each timeslot. If this line is set to logical "0" switchover is made to the left mapping MAP_{M-1} . This means a reduction of the output power by POWER_STEP for all channels with POWER_CONTROL = UP. The power of channel 1 is increased by the same value.

If the LEVATT line is set to logical "0" switchover is made to the right mapping MAP_{M+1} . This means an increase of the output power by POWER_STEP for all channels with POWER_CONTROL = UP. The power of channel 1 is decreased by the same value.

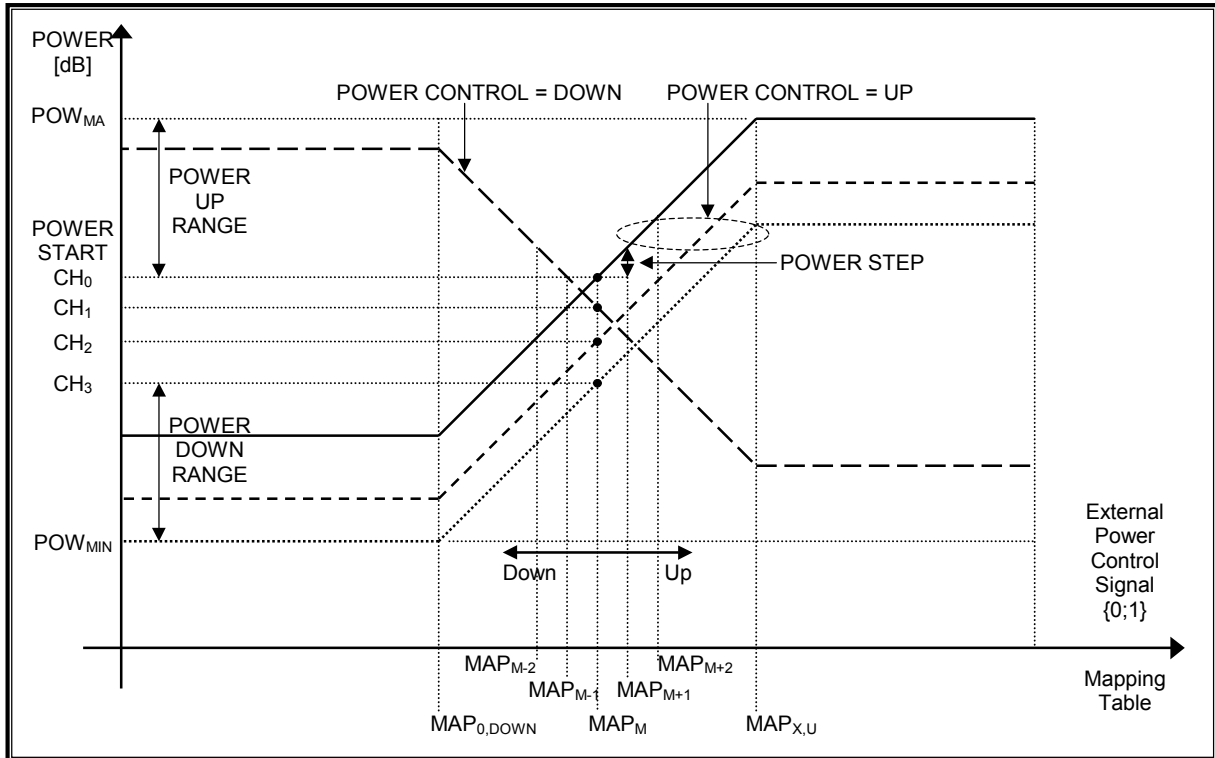

Fig. 2-171 Change of channel power of 4 enhanced channels

External Power Control

EXTERNAL POWER CONTROL STATE

Switch for activating or deactivating the external power control mechanism of all enhanced channels.

In the OFF state, the following menu parameters are not effective:

POWER UP RANGE,
 POWER DOWN RANGE,
 POWER STEP,
 POWER CONTROL GRAPH ?,
 POWER START DPCCH,
 POWER START DPDCH,
 POWER START (enhanced channel-specific).
 POWER CONTROL (enhanced channel-specific).

IEC/IEEE-bus command : SOUR : W3GP : BST : ENH : EPOW : STAT ON

POWER STEP

Step width (0.25 to 6.0 dB) by which – with the external power control mechanism being switched on - the channel powers of the activated enhanced channels in the timeslot grid are increased or decreased within the set dynamic range.

IEC/IEEE-bus command : SOUR : W3GP : BST : ENH : EPOW : STEP 1.0

POWER UP RANGE

Dynamic range (0 to 30 dB) by which – with external power control mechanism switched on – the channel powers of all activated enhanced channels can be increased. The value POWER UP RANGE can be changed by POWER STEP. If the dynamic range is exceeded, the warning MAX. POWER UP REACHED is displayed.

The resulting external power control dynamic range (= POWER UP RANGE – POWER DOWN RANGE) may be 30 dB at max. which is why the POWER UP RANGE is limited as a function of the POWER DOWN RANGE.

IEC/IEEE-bus command : SOUR:W3GP:BST:ENH:EPOW:RANG:UP 10.0

POWER DOWN RANGE

Dynamic range (0 to 30 dB) by which – with external power control mechanism switched on – the channel powers of all activated enhanced channels can be decreased. The value POWER UP RANGE can be changed by POWER STEP. If the dynamic range is underranged, the warning MAX. POWER UP REACHED is displayed.

The resulting external power control dynamic range (= POWER UP RANGE – POWER DOWN RANGE) may be 30 dB at max. which is why the POWER DOWN RANGE is limited as a function of the POWER UP RANGE.

IEC/IEEE-bus command : SOUR:W3GP:BST:ENH:EPOW:RANG:DOWN 10.0

POWER CONTROL GRAPH ►

With this menu parameter selected, the display window is opened again and - with external power control mechanism switched on - the "current" deviation of the channel power from the set power start value of the corresponding enhanced channels is displayed graphically(see section 2.15.3.3).

The display window is only shown if the EXTERNAL POWER CONTROL switch is set to ON and if the specific POWER CONTROL switch is positioned to UP or DOWN in the downlink for at least one enhanced channel.

Note : *This window is opened automatically after calculation of the signals triggered by STATE = ON or MOD ON but can be closed again manually by the user. This menu parameter allows the insertion of the window again without recalculating the signal.*

Note: *With Enhanced P-CCPCH/BCH State On in the downlink, only the DPCH is power-controlled. The P-CCPCH always has the power set in the enhanced channel table.*

2.15.3.1.5 Further Setting of Enhanced Channels Menu

-----Common Enhanced Channels Settings-----

SEQUENCE LENGTH P-CCPCH/BCH With Enhanced P-CCPCH/BCH State On in the downlink, the sequence length of the P-CCPCH/BCH is displayed. The length is always 4096 frames and cannot be edited.
IEC/IEEE-bus command (query) : SOUR:W3GP:BST:ENH:PCCP:SLen?

SEQUENCE LENGTH Sets the sequence length in radio frames used to calculate the 3 GPP W-CDMA enhanced channel signal component on DGEN.
Depending on the currently available free DGEN list memory, the currently available maximum frame sequence length is displayed in the middle of the menu parameter line.

Note : *After triggering a new calculation, the 3GPP W-CDMA signal component calculated on DGEN is stored in a hidden data list. The maximum number of radio frames depends on the currently available free DGEN list memory for the hidden data list max. 80 Mbit).*

In addition to the free DGEN list memory the maximum sequence length crucially depends on the ENHANCED P-CCPCH/BCH state and the number of DPCHs:

ENHANCED P-CCPCH/BCH STATE = OFF

1 DPCH:	1022 frames
2 DPCHs:	511 frames
3 DPCHs:	341 frames
4 DPCHs:	255 frames

ENHANCED P-CCPCH/BCH STATE = ON

SYMBOL RATE DPCH ≤30 ksps:	2044 frames
SYMBOL RATE DPCH >30 ksps:	500 frames

IEC/IEEE-bus command : SOUR:W3GP:BST:ENH:SLen 123

SYMBOL RATE DPCH Sets symbol rate of all downlink enhanced channels in ksps.
If the CHANNEL CODING STATE switch is set to ON, there is a close relation between the settings CODING TYPE and SYMBOL RATE DPCH:

MEASURE_12.2KBPS :	SYMBOL RATE DPCH = 30 ksps
MEASURE_64KBPS :	SYMBOL RATE DPCH = 120 ksps
MEASURE_144KBPS :	SYMBOL RATE DPCH = 240 ksps
MEASURE_384KBPS :	SYMBOL RATE DPCH = 480 ksps
AMR_CODEC :	SYMBOL RATE DPCH = 30 ksps;

When a parameter is changed (CODING TYPE or SYMBOL RATE DPCH) the associated parameter is adapted automatically.

In the higher BS1 menu the SYMBOL RATE settings of all activated enhanced channels are automatically updated in the channel table.

IEC/IEEE-bus command : SOUR:W3GP:BST:ENH:SRAT D30K

TIMING OFFSET

Sets a time offset (0 to 149) with which the corresponding downlink enhanced channels are sent. (The resulting crest factor of the overall signal can be influenced).

The timing offset can be set in an interval of 256 chips.

IEC/IEEE-bus command : SOUR:W3GP:BST:ENH:TOFF 1

PILOT LENGTH

Sets the pilot field size in the timeslots of the corresponding downlink enhanced channels (2, 4, 8 or 16 depending on the symbol rate).

IEC/IEEE-bus command : SOUR:W3GP:BST:ENH:PLEN BIT4

-----Specific Enhanced Channel Settings-----

CHANNEL NUMBER Display parameter for the assigned serial number of a downlink enhanced DPCH or an uplink enhanced DPDCH from the BS1 or MS1 channel table. The enhanced channels are assigned to the first 4 dedicated channels in the BS1 channel table or to the DPCCH/DPDCH of the MS1 channel table. With Enhanced P-CCPCH/BCH State On in the downlink, also the P-CCPCH with channel number 4 is available.

STATE Switch for activating or deactivating the corresponding downlink enhanced channel. In the ON state the channel is marked as enhanced channel by an additional E (in addition to CH. NO) in the channel table line determined by the CHANNEL NUMBER in the higher BS1 menu – under the precondition that the ENHANCED CHANNELS STATE switch is set to ON. In the OFF state, the following channel-specific menu parameters are not effective:
 CHAN CODE
 POWER START
 POWER CONTROL
 DATA
 TPC
 MULTI CODE

In the higher BS1 menu, the STATE parameter has to be updated in the channel table line determined by the ENHANCED CHANNEL NUMBER.

Note: *The enhanced channels cannot be activated individually in the uplink; the required enhanced channels are automatically activated via the OVERALL SYMBOL RATE setting.*

IEC/IEEE-bus command : SOUR:W3GP:BST:ENH:CHAN11:STAT ON

TYPE Display parameter for the channel type of the corresponding enhanced channel. The type is taken from the TYPE parameter of the channel table line or column determined by the ENHANCED CHANNEL NUMBER with the channel table belonging to the higher BS1/MS1 menu. In the downlink, enhanced channels have the DPCH type and in the uplink, the DPCCH type (1st enhanced channel) or DPDCH (2nd to 4th enhanced channel). With Enhanced P-CCPCH/BCH State On in the downlink, channel type P-CCPCH is additionally available in the table.

CHAN CODE	<p>Sets the corresponding enhanced channel.</p> <p><u>Downlink:</u></p> <p>The channelization codes of the downlink enhanced channels are variable from 0 to -1 (3.840 MCPS/enhanced channel symbol rate). In the higher BS1 menu, the CH. CODE parameter is updated in the channel-table line determined by the ENHANCED CHANNEL NUMBER.</p> <p>With Enhanced P-CCPCH/BCH State On in the downlink, the P-CCPCH automatically has the data rate of 15 ksps and the channelization code 1 stipulated in the standard.</p> <p><u>Uplink:</u></p> <p>The channelization codes of the uplink enhanced channels are constant and described in [2].</p> <p>IEC/IEEE-bus command : SOUR:W3GP:BST:ENH:CHAN11:CHNC 0</p>
POWER START	<p>Sets the channel (start) power of the corresponding downlink enhanced channel. If the EXTERNAL POWER CONTROL STATE switch is set to ON and the channel-specific POWER CONTROL switch to UP or DOWN, this value is the channel start power for the external power control mechanism. In the higher BS1 menu, the POWER DB parameter has to be updated in the channel table line determined by the ENHANCED CHANNEL NUMBER.</p> <p>Note : <i>By starting the ADJUST TOTAL POWER menu parameter in the upper menu level of 3GPP W-CDMA all channel powers (POWER DB parameter) of the BS1 channel table and thus also the POWER START values of the set enhanced channel are adapted so that the average overall power of all activated channels is 0 dB with reference to the LEVEL indicated in the SMIQ display.</i></p> <p>In the uplink, the channel start powers are determined via the parameters POWER START DPCCH and POWER START DPDCH.</p> <p>IEC/IEEE-bus command : SOUR:W3GP:BST1:ENH:CHAN11:POW:STAR -30.0</p>
POWER CONTROL	<p>Switch indicating the direction (UP or DOWN) with external power control mechanism activated – with which the channel power of the corresponding downlink enhanced channel is changed in the POWER STEP. The link is with reference to the high level of the external power control TTL signal at the beginning of the pilot field of a timeslot.</p> <p>In the OFF state, the corresponding downlink enhanced channel of the external power control mechanism is not taken into account.</p> <p>IEC/IEEE-bus command : SOUR:W3GP:BST:ENH:CHAN1:POW:CONT UP</p> <p>Note: <i>The Power Control parameter is not provided with P-CCPCH since it is not power-controlled.</i></p>
DATA DATA DTCH DATA DCCH	<p>If channel coding is inactive, the data source for the data fields of the timeslots of the corresponding enhanced channel can be selected here (DATA DTCH and DATA DCCH are not displayed in this case.).</p> <p>If channel coding is active, data sources can be selected for the two components of the channel (DTCH and DCCH).</p> <p>In a submenu the data sources PN9, PN11, PN15, PN16, ALL0, ALL1 and a 24-bit PATTERN as well as any data lists DLISTxx can be selected. In the first uplink enhanced channel (DPCCH) a data source cannot be indicated since no data field is available for this channel in the timeslots.</p> <p>IEC/IEEE-bus : SOUR:W3GP:BST:ENH:CHAN1:DATA PN9 IEC/IEEE-bus : SOUR:W3GP:BST:ENH:CHAN1:DATA:PATT #H3F, 8 IEC/IEEE-bus : SOUR:W3GP:BST:ENH:CHAN1:DATA:DSEL 'name'</p>

TPC	<p>Selects the data source for the TPC fields of the timeslots of the corresponding enhanced channel.</p> <p>In a submenu the data sources ALL0, ALL1 and a 24-bit PATTERN as well as any data lists DLISTxx can be selected.</p> <p>Only one bit is read out from the data source per TPC field. This bit is then multiplied in the whole TPC field.</p> <p>IEC/IEEE-bus : SOUR:W3GP:BST:ENH:CHAN1:TPC ONE IEC/IEEE-bus : SOUR:W3GP:BST:ENH:CHAN1:TPC:PATT #H3F, 8</p>
MULTI CODE	<p>Switch with which the multicode channel trunking of the corresponding downlink enhanced channel can be activated or deactivated with other dedicated channels.</p> <p>All dedicated channels of a base station whose multicode switch is set to ON are trunked to form one virtual channel – irrespective of whether they are declared as enhanced dedicated channels or as normal dedicated channels.</p> <p>IEC/IEEE-bus command : SOUR:W3GP:BST:ENH:CHAN1:MCOD OFF</p>
SELECT DATA LIST...	Selects an available data list or generation of a new data list (in the submenu). The currently selected data list is displayed on the right.
CURRENT: DLIST01	IEC/IEEE-bus command : SOUR:W3GP:BST:ENH:DSEL 'ABC'
COPY CURRENT DATA LIST TO...	<p>Copies the contents of the current data list into an existing or new data list.</p> <p>IEC/IEEE-bus command : SOUR:DM:DLIS:COPY 'ABC'</p>
DELETE DATA LIST...	<p>Deletes an existing data list.</p> <p>IEC/IEEE-bus command : SOUR:DM:DLIS:DEL 'ABC'</p>
EDIT DATA LIST...	Edits an existing data list.

2.15.3.2 Uplink

Only the uplink parameters are described here. If the parameters of section 2.15.3.1 are also available in the uplink, :BST has to be replaced by :MST for the corresponding remote-control command.

FREQ 2.000 000 000 0 GHz		LEVEL 0.0 dBm				
		PEP +3.6 dBm				
WCDMA/3GPP		ALC-S&H				
ENHANCED CHANNELS STATE		OFF <input type="checkbox"/> ON <input type="checkbox"/>				
Channel Coding						
CHANNEL CODING STATE		OFF <input type="checkbox"/> ON <input type="checkbox"/>				
CODING TYPE...		MEASURE 12.2				
INTERLEAVER 1		OFF <input type="checkbox"/> ON <input type="checkbox"/>				
INTERLEAVER 2		OFF <input type="checkbox"/> ON <input type="checkbox"/>				
DPDCH Bit Error Insertion						
INSERT BIT ERRORS IN DATA		<input type="checkbox"/> OFF ON <input type="checkbox"/>				
NOMINAL BIT ERROR RATE		1.000 0 E-03				
RESULTING BIT ERROR RATE DTCH		0 E-09				
RESULTING BIT ERROR RATE DCCH		0 E-09				
INSERT BLOCK ERRORS		<input type="checkbox"/> OFF ON <input type="checkbox"/>				
NOMINAL BLOCK ERROR RATE		100 E-03				
RESULTING BLOCK ERROR RATE DTCH		0 E-09				
RESULTING BLOCK ERROR RATE DCCH		0 E-09				
External Power Control						
EXTERNAL POWER CONTROL STATE		<input type="checkbox"/> OFF ON <input type="checkbox"/>				
POWER STEP		1.00 dB				
POWER UP RANGE		10.0 dB				
POWER DOWN RANGE		10.0 dB				
Common Enhanced Channels Settings						
SEQUENCE LENGTH DPDCH	CURRENT MAX: 1 042 Frame	2 Frame				
OVERALL SYMBOL RATE...		<input type="checkbox"/> 60 kSPS				
POWER DPDCH		0.0 dB				
ENHANCED DPCCH STATE		<input type="checkbox"/> OFF ON <input type="checkbox"/>				
POWER DPCCH		0.0 dB				
Specific Enhanced Channels Settings						
CHANNEL NUMBER	1 E	2 E	3 E	4 E	5 E	6 E
TYPE	DPDCH					
SYMBOL RATE	60					
CHAN CODE	16					
DATA DTCH	PN15					
DATA DCCH	PN15					
CHANGE DATA						
SELECT DATA LIST...	CURRENT: NONE					
COPY CURRENT DATA LIST TO...						
DELETE DATA LIST...						
▼ EDIT DATA LIST...						

Fig. 2-172 DIGITAL STD - WCDMA/3GPP - ENHANCED CHANNELS STATE (uplink) menu

-----External Power Control-----

EXTERNAL POWER CONTROL STATE	<p>Switch for activating or deactivating the external power control mechanism of all enhanced channels.</p> <p>In the OFF state, the following menu parameters are not effective: POWER UP RANGE, POWER DOWN RANGE, POWER STEP,</p> <p>IEC/IEEE-bus command : SOUR : W3GP : MST : ENH : EPOW : STAT ON</p>
POWER STEP	<p>Step width (0.25 to 6.0 dB) by which – with the external power control mechanism switched on – the channel powers of the activated enhanced channels in the timeslot grid are increased or decreased within the set dynamic range.</p> <p>IEC/IEEE-bus command : SOUR : W3GP : MST : ENH : EPOW : STEP 1.0</p>
POWER UP RANGE	<p>Dynamic range (0 to 30 dB) in which – with the external power control mechanism switched on – the channel powers of all the activated enhanced channels can be increased. The value POWER UP RANGE can be changed by POWER STEP. If the dynamic range is exceeded, the warning "MAX. POWER UP REACHED" is displayed.</p> <p>The resulting external power control dynamic range (= POWER UP RANGE – POWER DOWN RANGE) must not exceed 30 dB. For this reason, the POWER UP RANGE is limited as a function of the POWER DOWN RANGE.</p> <p>IEC/IEEE-bus command : SOUR : W3GP : MST : ENH : EPOW : RANG : UP 10.0</p>
POWER DOWN RANGE	<p>Dynamic range (0 to 30 dB) in which – with the external power control mechanism switched on – the channel powers of all the activated enhanced channels can be decreased. The value POWER DOWN RANGE can be changed by POWER STEP. If the dynamic range is underranged, the warning "MIN. POWER DOWN REACHED" is displayed.</p> <p>The resulting external power control dynamic range (= POWER UP RANGE – POWER DOWN RANGE) must not exceed 30 dB. For this reason, the POWER DOWN RANGE is limited as a function of the POWER UP RANGE.</p> <p>IEC/IEEE-bus command : SOUR : W3GP : MST : ENH : EPOW : RANG : DOWN 10.0</p>

-----Common Enhanced Channel Settings-----

OVERALL SYMBOL RATE

Sets the overall symbol rate in ksps and the required uplink DPDCHs. For an overall uplink symbol rate of up to 960 ksps only one DPDCH is required in addition to the normally available DPCCH. Further DPDCHs with 960 ksps each are added to the signal to obtain a higher overall symbol rate (maximum 6 DPDCHs).

The enhanced channel table is adapted depending on the setting for OVERALL SYMBOL RATE (e.g. number of active enhanced channels). In the channel table of the higher MS1 menu, the enhanced channels are marked by an additional E (in addition to CHANNEL NUMBER).

If the CHANNEL CODING STATE switch is set to ON, there is a close relation between the settings CODING TYPE and OVERALL SYMBOL RATE:

MEASURE__12.2:	OVERALL SYMBOL RATE = 60 ksps
MEASURE__64:	OVERALL SYMBOL RATE = 240 ksps
MEASURE_144:	OVERALL SYMBOL RATE = 480 ksps
MEASURE_384:	OVERALL SYMBOL RATE = 1 * 960 ksps
AMR_CODER:	SYMBOL RATE DPDCH = 60 ksps;

When a parameter is changed (CODING TYPE or OVERALL SYMBOL RATE) the associated parameter is adapted automatically.

IEC/IEEE-bus command : SOUR:W3GP:MST:ENH:ORAT X2

DPDCH POWER

Sets the channel power (-60 dB to 0 dB) of the DPDCHs. Each active DPDCH is sent with this power. If the EXTERNAL POWER CONTROL STATE switch is set to ON, this power is also the start power for the power control.

Note: *Starting the ADJUST TOTAL POWER menu parameter at the top menu level of 3GPP W-CDMA adapts all the channel powers (POWER DB parameter) of the mobile stations (and, thus, also the POWER START values of the set enhanced channels) so that the average overall power of all the activated channels is 0 dB with reference to the LEVEL in the SMIQ display.*

IEC/IEEE-bus command : SOUR:W3GP:MST:ENH: POW:DPDC -30.0

ENHANCED DPCCH STATE

This parameter is used to determine whether the DPCCH is calculated as enhanced channel (on the data generator) or as "normal" channel (on the modulation coder).

STATE = ON:

The DPCCH is calculated as enhanced channel. This setting is useful when External Power Control is active.

STATE = OFF:

The DPCCH is calculated as a normal channel. This setting is useful for all measurements which require no External Power Control.

IEC/IEEE-bus : SOUR:W3GP:MST:ENH:DPCC:STAT OFF

DPCCH POWER

Sets the channel power (-60 dB to 0 dB) of the DPCCH. If the EXTERNAL POWER CONTROL STATE switch is set to ON, this power is also the start power for power control.

Note : Starting the ADJUST TOTAL POWER menu parameter at the top menu level of 3GPP W-CDMA adapts all the channel powers (POWER DB parameter) of the mobile stations (and, thus, also the POWER START values of the set enhanced channel) so that the average overall power of all the activated channels is 0 dB with reference to the LEVEL indicated in the SMIQ display.

IEC/IEEE-bus command : SOUR:W3GP:MST:ENH:POW:DPCC -
30.0

-----Specific Enhanced Channel Settings-----

SYMBOL RATE

Display parameter indicating the symbol rates of the individual uplink enhanced channels.

2.15.3.3 Display of External Power Control Mode of Four Enhanced Channels

The current External Power Control mode of the four enhanced channels is displayed here. The deviation of the channel power (= ΔPOW) of the set POWER START caused by the external power control mechanism is displayed in graphical form.

The window is shown in the SMIQ display after calculating the 3GPP W-CDMA signal triggered by STATE = ON or MOD ON. The window is blanked out after pressing the RETURN key to be able to operate the SMIQ during the signal output.

Since a realtime update of the window in the timeslot (= 0.667 ms) is not possible for reasons of speed, an update can be performed in a more coarse time interval. Fast channel power changes are not displayed but the settled state of the control loop can be recognized very easily by the user.

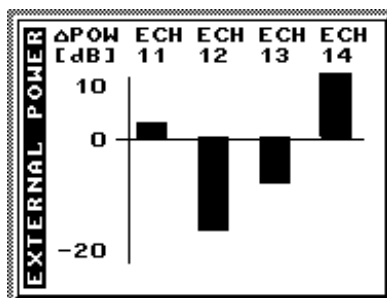

Fig. 2-173 Display of external power control mode

2.15.4 OCNS Channels

A so-called Orthogonal Channel Noise (OCNS) has to be simulated for testing the maximum input level ([1], 7.4) of mobile stations (user equipment).

In addition to the 12.2 kbps measurement channel the base station signal comprises further high-power orthogonal channels and a PCCPCH.

The OCNS setting function has a similar effect as Para. Predef. (see sect. Digital Standard 3GPP W-CDMA), i.e. all parameters of the WCDMA/3GPP system are set to useful values.

2.15.4.1 OCNS Menu

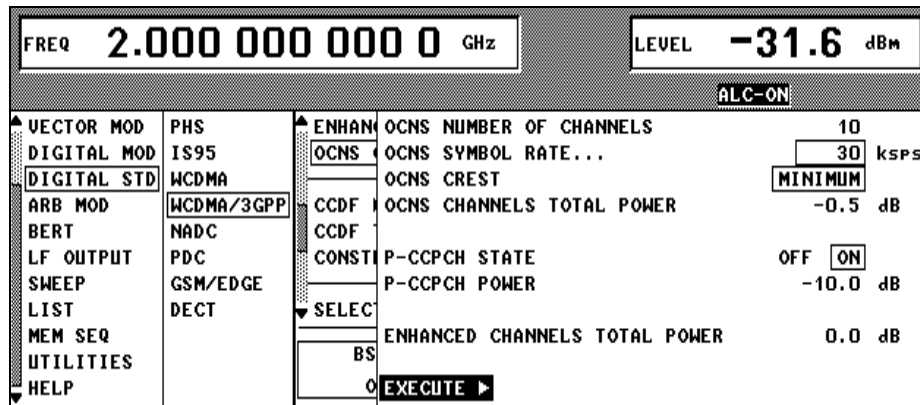

Fig. 2-174 DIGITAL STD - WCDMA/3GPP - OCNS CHANNELS menu

OCNS NUMBER OF CHANNELS

Number of OCNS channels additionally added to the 3GPP W-CDMA signal (in addition to the enhanced channels). The maximum number of OCNS channels depends on the OCNS symbol rate:

MAX_NOF_OCNS_Channels =
(Chip rate / OCNS SYMBOL RATE)
– 4 enhanced channels

This menu parameter is only effective after pressing EXECUTE ►.

IEC/IEEE-bus command : SOUR:W3GP:BST:OCNS:COUN 10

OCNS SYMBOL RATE

Sets the symbol rate of all OCNS channels in kSPS.

This menu parameter is only effective after pressing EXECUTE ►.

IEC/IEEE-bus command : SOUR:W3GP:BST:OCNS:SRAT D240K

OCNS CREST

The crest factor of the OCNS signal can be influenced by setting the channelization codes and timing offsets.

MINIMUM: The crest factor is minimized (the channelization codes are distributed uniformly over the code domain, the timing offsets are increased by 3 from channel to channel).

IEC/IEEE-bus command : SOUR:W3GP:BST:OCNS:CRES MIN

AVERAGE: An average crest factor is set (the channelization codes are distributed uniformly over the code domain, the timing offsets are all set to 0).

IEC/IEEE-bus command : SOUR:W3GP:BST:OCNS:CRES AVER

WORST: The crest factor is set to an unfavourable value (i.e. maximum) (the channelization codes are assigned in ascending order. The timing offsets are all set to 0).

IEC/IEEE-bus command : SOUR:W3GP:BST:OCNS:CRES WORS

OCNS CHANNELS TOTAL POWER	<p>Fraction of power of OCNS channel signal component at the overall signal normalized to 0 dB. This menu parameter is only effective after pressing EXECUTE ►.</p> <p>IEC/IEEE-bus command : SOUR:W3GP:BST:OCNS:POW -10.0</p>
P-CCPCH STATE	<p>Switch with which the P-CCPCH can be added to the OCNS dedicated channels. This menu parameter is only effective after pressing EXECUTE ►.</p> <p>IEC/IEEE-bus command : SOUR:W3GP:BST:OCNS:PCCP:STAT ON</p>
P-CCPCH POWER	<p>Fraction of power of P-CCPCH signal component at the overall signal normalized to 0 dB. This menu parameter is only effective after pressing EXECUTE ►.</p> <p>IEC/IEEE-bus command : SOUR:W3GP:BST:OCNS:PCCP:POW -10.0</p>
ENHANCED CH. TOTAL POWER	<p>Fraction of power of enhanced channel signal component at the overall signal normalized to 0 dB. The value for ENHANCED CH. TOTAL POWER is determined from the POWER START values of all activated enhanced channels and offered to the user as default value. If the user changes this value, also the values for POWER START of the activated enhanced channels are adapted. If all enhanced channels are inactive, ENHANCED CH. TOTAL POWER are set to -60.0 dB.</p> <p>This menu parameter is only effective after pressing EXECUTE ►.</p> <p>IEC/IEEE-bus command : SOUR:W3GP:BST:OCNS:EPOW -10.0</p>
EXECUTE ►	<p>The EXECUTE command is used to validate the settings described above and to fill in the channel tables of the base stations.</p> <p>The rules for filling in the channel tables correspond to those of the PARA.PREDEF SETTING... menu parameter with the following exceptions:</p> <p>The first 4 DPCHs are reserved for the enhanced channels. The OCNS channel settings are entered from the 5th DPCH in the channel table. The maximum number of DPCHs (= OCNS channels) is reduced by 4 (= number of enhanced channels).</p> <p>S-CCPCH is switched off (STATE = OFF).</p> <p>The channel power values of OCNS channels must be determined from menu parameters NUMBER OF OCNS CHANNELS and OCNS CHANNELS TOTAL POWER. The P-CCPCH channel power is taken over from P-CCPCH POWER menu parameter (if P-CCPCH is switched on) .</p> <p>IEC/IEEE-bus command : SOUR:W3GP:BST:OCNS:EXEC</p>

2.15.4.2 Test of Maximum Input Level with SMIQ

To test the maximum input level of a mobile station (UE) (according to [1], 7.4) proceed as follows:

1. In the DIGITAL-STD menu select menu item SET DEFAULT to set all parameters to defined values.
2. Set sequence length to 13. (see section 2.15.4.3)
3. Enter the DIGITAL STD-WCDMA/3GPP-ENHANCED CHANNELS menu.
4. Set STATE to ON.
5. Set CHANNEL CODING STATE to ON.
6. Select CODING TYPE = MEASURE__12.2 and switch on both interleavers.
7. Switch off EXTERNAL POWER CONTROL.
8. Select a sequence length of 1022 (see section 2.15.4.3).
9. Activate channel 11 (STATE to ON), all other channels are inactive.
10. Set the following parameters for channel 11:
 CHAN CODE = 25 (not defined in [1], other code also possible)
 DATA DTCH = PN9
 DATA DCCH = PN15 (not defined in [1], other data also possible)
11. Change to the DIGITAL STD-WCDMA/3GPP-OCNS CHANNELS menu.
12. Set number of channels (NUMBER OF CHANNELS) to 60. (A value for [1] is not given but a utilization of 50% for the code domain is recommended.)
13. Set SYMBOL RATE to 30 ksps. (A value is not given in [1] but normal voice channels are recommended.)
14. Select CREST=MINIMUM.
15. Set OCNS CHANNELS TOTAL POWER to -1 dB.
16. Activate P-CCPCH (STATE=ON).
17. Select -12 dB as P-CCPCH POWER.
18. Set ENHANCED CHANNELS TOTAL POWER to -19 dB.
19. Activate EXECUTE.
20. Change to the DIGITAL STD-WCDMA/3GPP - BS1 menu.
21. Set TFCI STATE = ON.
22. Activate P-CPICH with -10 dB.
23. Activate P-SCH and S-SCH with -15 dB each.
24. Activate PICH with -15 dB. Select its channelization code so that no domain conflict occurs.

Overview of all active channels in the OCNS measurement:

Table 2-28 OCNS channels

Physical channel	Power (log.)	Power (lin.)	
DPCH (measurement)	-19 dB	1.26 %	
CPICH	-10 dB	10.0 %	
PCCPCH	-12 dB	6.30 %	
SCH	-12 dB	6.30 %	-15 dB for P-SCH and -15 dB for S-SCH
PICH	-15 dB	3.16 %	
OCNS	-1 dB	79.3 %	60 channels, -18.8 dB each

2.15.4.3 Favourable Sequence Length for OCNS Measurement

To perform a realistic OCNS measurement, certain sequence length combinations are to be preferred. Both signal components (measurement channel and OCNS channels) are cyclically output. The cycle length of the measurement channel can be entered in the ENHANCED CHANNEL (SEQUENCE LENGTH) menu, the cycle of the OCNS channel in the WCDMA/3GPP menu.

If these lengths are identical, also the overall signal is repeated with this cycle length. If the two lengths are different, the overall signal is repeated with a cycle length that corresponds to the least common multiple of the individual lengths.

To simulate a real base-station signal optimally, the overall cycle length should be selected as large as possible. Therefore, both sequence lengths should be relatively prime. This is the case if two prime numbers are used, for example. The overall cycle length then becomes the product of the two sequence lengths.

The values in section 2.15.4.2 are selected so that the overall cycle length becomes a maximum (1022*13 frames = 133 seconds).

Note : To reduce the computation time for the signal it can be useful to use smaller sequence lengths.

2.15.5 Additional MS Based On MS4

Similar to simulating a realistic downlink signal for testing a mobile station receiver with OCNS (section 2.15.4), there is a realistic uplink signal (for testing a base station receiver) consisting of the individual signals of many mobile stations.

Up to three mobile stations are configured, see section "Digital Standard 3GPP W-CDMA" and section "WCDMA/3GPP menu - Submenu MS Configuration".

The fourth mobile station MS4 is used as a reference for all other stations. Based on the settings of this mobile station, all Additional Mobile Stations are calculated and the following parameters are modified:

- Scrambling code (all stations are different)
- Power (different from MS4, but same power)

FREQ 2.000 000 000 0 GHz		LEVEL -30.0 dBm	
ALC-ON			
▲ FREQUENCY	PHS	▲ CLIPP	ADDITIONAL MS STATE
LEVEL	IS95	FILTE	OFF ON
ANALOG MOD	WCDMA		NUMBER OF ADDITIONAL MS
VECTOR MOD	WCDMA/3GPP		4
DIGITAL MOD	NADC	ENHAN	SCRAMBLING CODE STEP
DIGITAL STD	PDC		0001 H
ARB MOD	GSM/EDGE	▲ ADDIT	POWER OFFSET
BERT	DECT	▼ SELEC	0.0 dB
LF OUTPUT			
SWEEP			
▼ LIST			

Fig. 2-175 DIGITAL STD - WCDMA/3GPP ADDITIONAL MS STATE menu

ADDITIONAL MS STATE	<p>Switch with which up to 50 additional mobile stations can be added (ON) to a 3GPP W-CDMA signal (defined in MS1 to MS4) otherwise all additional MS are deactivated (OFF).</p> <p>The additional MS are also calculated on the MCODE and added to the ARB memory with the signal component of the primary MS.</p> <p>The basic settings of the additional mobile stations (e.g. Signature, Access Slot, TFCI, FBI and TPC settings as well as the channel scenario from PRACH, PCPCH, DPCCH + DPDCHs) are taken over from the primary reference mobile station 4.</p> <p>In the OFF state, the following menu parameters have no influence on the 3GPP W-CDMA signal:</p> <p>NUMBER OF ADDITIONAL MS, SCRAMBLING CODE STEP, POWER OFFSET [RELATIVE TO MS4].</p> <p>IEC/IEEE-bus command : SOUR:W3GP:MST:ADD:STAT ON</p>
NUMBER OF ADDITIONAL MS	<p>Number of additional mobile stations 1 to 64.</p> <p>IEC/IEEE-bus command : SOUR:W3GP:MST:ADD:COUNT 33</p>
SCRAMBLING CODE STEP	<p>Initialization increment of uplink scrambling code generator for additional mobile stations. The scrambling code value of the primary reference MS4 is used as the basic value of the scrambling code initialization of an additional MS.</p> <p>IEC/IEEE-bus command : SOUR:W3GP:MST:ADD:SCOD:STEP 5</p>
POWER OFFSET	<p>With this menu parameter it is possible to set a power offset of the active channels of the additional MS relative to the powers of the active channels of the primary reference MS4.</p> <p>The resulting power value of the channel must be in the range from 0 to -60 dB (limitation in case of underrange or overrange).</p> <p>IEC/IEEE-bus command : SOUR:W3GP:MST:ADD:POW:OFFS -3.0</p>

2.16 Digital Standard NADC

With the options Modulation Coder (SMIQB20) and Data Generator (SMIQB11) provided, modulation signals according to the American NADC standard (IS-54¹ or IS-136) can be generated. NADC is a TDMA standard for cellular mobile radio networks.

SMIQ can generate both the transmit signal of a base station (BS) and the transmit signal of a mobile station (MS). Transmission from BS to MS is called "downlink", "uplink" being used for transmission in the opposite direction.

Each TDMA frame consists of 6 slots. The 6 slots can be configured for both full rate and half rate mode. For half rate, the data content for each of the 6 slots can be defined separately by means of a slot editor whereas in the full rate mode 2 slots for example slot 1 and 4 are combined in a frame. The settings for the first slot are then automatically used for the assigned second slot. Each slot can be switched on or off. Moreover, a defined intermediate level can be set for uplink slots.

A burst type has to be defined to configure a slot. The following burst types can be selected:

- TCH a traffic channel burst with a different structure for uplink and downlink,
- SHORT the so-called "shortened burst" only available during uplink and,
- ALL_DATA burst type for test purposes with freely programmable data contents in the selected slot.

The following internal modulation sources are available:

- different PRBS generators with a sequence length between 2^9-1 and $2^{23}-1$ and
- data lists, ie freely programmable data sequences from the data generator memory.

For generating the NADC signals, SMIQ inserts the modulation data continuously (in real time) into the selected slots. Using a digital signal processor the data generator generates a data sequence with modulation data and control signals for envelope control.

The data generator in SMIQ generates a data stream which is converted into IQ signals in the modulation coder. According to the NADC standard, the modulation type is $\pi/4$ DQPSK at a symbol rate of 24.3 ksymbol/s and $\sqrt{\text{COS}}$ filtering. Symbol rate and filtering can be changed in SMIQ.

¹ Personal Handy Phone System ARIB Standard (RCR STD-28)

2.16.1 Sync and Trigger Signals

The data generator generates a data sequence with modulation data, control signals for envelope control, and synchronization signals.

When TRIGGER MODE AUTO is selected, the NADC signal generation is started automatically.

This start can also be activated by an external trigger signal (TRIGGER MODE ARMED_AUTO) which allows a synchronous sequence for BER measurements to be carried out on receivers.

A trigger signal can be fed via the TRIGIN input at connector PAR DATA. The active slope of a trigger signal applied there executes a trigger event.

NADC signal generation at a frame limit is started after a trigger event. Data from data lists are inserted into the selected slots starting from the first bit. PRBS generators start with the set initialization status.

Signal generation either starts immediately after the active slope of the trigger signal or after a settable number of symbols (EXT TRIGGER DELAY). Retriggering (RETRIG) can be inhibited for a settable number of symbols (EXT RETRIGGER INHIBIT).

A trigger event can be executed manually or via the IEC/IEEE bus using EXECUTE TRIGGER.

When a trigger event is executed, a trigger signal is output at the TRIGOUT 3 output of SMIQ.

SMIQ also generates the following sync signals:

- a frame clock at TRIGOUT 1 output,
- a frame or multiframe clock at TRIGOUT 2 output with settable position in the frame,
- the symbol clock and the bit clock.

A clock synthesizer on the modulation coder generates the symbol clock and the bit clock in SMIQ. All the clock signals are synchronized to the 10-MHz reference of SMIQ. The symbol clock is available at connector SYMBOL CLOCK and the bit clock at connector BIT CLOCK. If required, the clock synthesizer in SMIQ can be synchronized to an external symbol or bit clock.

The clock signal is selected in the menu via CLOCK-CLOCK SOURCE EXT.

To allow for a trouble-free synchronization of the clock synthesizer first apply the external clock and set the correct symbol rate at SMIQ. Then switch CLOCK SOURCE from INT to EXT.

Note: *The set symbol rate should not differ by more than 1% from the symbol rate of the external signal.*

2.16.2 PN Generators as Internal Data Source

Independent PN generators (Pseudo Noise) can be selected for each slot as data source for data fields DATA and SACCH. These PN generators provide pseudo-random bit sequences of different length or period. That is why they are also called PRBS generators (Pseudo Random Binary Sequence). Data sequences are sequences of maximum length which are generated by means of feedback shift registers.

The following figure gives an example of a 9 bit generator with feedbacks after register 4 and 0 (output).

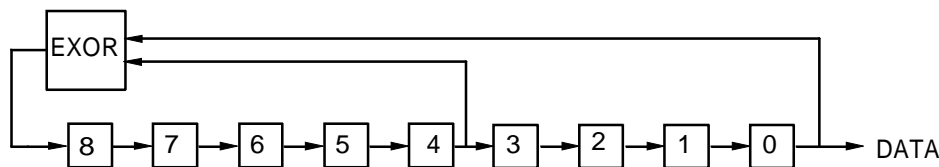

The pseudo-random sequence of a PRBS generator is clearly defined by the number of registers and the feedback. The following table describes all PRBS generators available:

Table 2-29 PRBS generators for NADC

PRBS generator	Length in bits	Feedback after
9 bit	$2^9 - 1 = 511$	Register 4, 0
11 bit	$2^{11} - 1 = 2047$	Register 2, 0
15 bit	$2^{15} - 1 = 32767$	Register 1, 0
16 bit	$2^{16} - 1 = 65535$	Register 5, 3, 2, 0
20 bit	$2^{20} - 1 = 1048575$	Register 3, 0
21 bit	$2^{21} - 1 = 2097151$	Register 2, 0
23 bit	$2^{23} - 1 = 8388607$	Register 5, 0

PN generators PN9,11,15,20 and PN23 are configured according to CCITT Rec. 0.151/152/153. The output sequence is inverted for generators PN15 and PN23.

The start value of the PN generators is different in the slots and equals

$$\text{start value} = 1 + 14 \text{ hex} \times \text{slot number}$$

Example: PN9 generator in slot 1 with start value 15hex = 10101 binary.

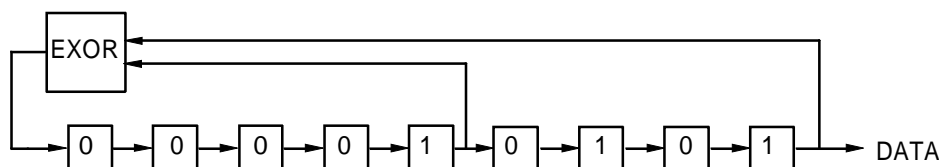

The resulting output sequence is 1010100000010100101011110010 etc.

2.16.3 Lists as Internal Data Source

A freely programmable memory on the data generator serves as internal data source for the data fields of the slots. The data are managed in so-called lists. A list editor allows to select, copy, modify and delete data lists (DATA LIST).

The list editor is available via menu DIGITAL-MOD - SOURCE....

2.16.4 External Modulation Data

External data can (only) be applied via the SERDATA interface. A selection of SERDATA as data source is only possible for a single data field of a slot. For further information on the characteristics of the SERDATA interface see Annex A.

To ensure that the external data bits are assigned to specific positions in the data field of the selected slot and that they are reproducible, the buffer of the RS-232 transmitter and receiver has to be deleted. A triggered start has to follow.

The following setting sequence is required in the DIGITAL STD - NADC menu:

1. Carry out desired settings in menu.
2. Select data source SERDATA for the data field of the slot using SELECT SLOT -
3. Make connection to external data source, but do not yet start external data source.
4. Switch off digital standard using STATE - OFF.
5. Set TRIGGER MODE ARMED_AUTO.
In this state, SMIQ is ready for reception, but discards data that are read in via SERDATA.
6. Switch on digital standard with STATE ON.
7. Start external data source.
The read-in data are written into the receiving buffer. Only if this buffer is filled can SMIQ react to a trigger event.
8. Activate trigger event. Signal generation is thus started at a frame limit. The first bit received via SERDATA is put to the first bit position in the selected data field.

2.16.5 Menu DIGITAL STANDARD - NADC

Menu DIGITAL STD - NADC provides access to settings for generating NADC signals.

Menu selection: DIGITAL STD - NADC

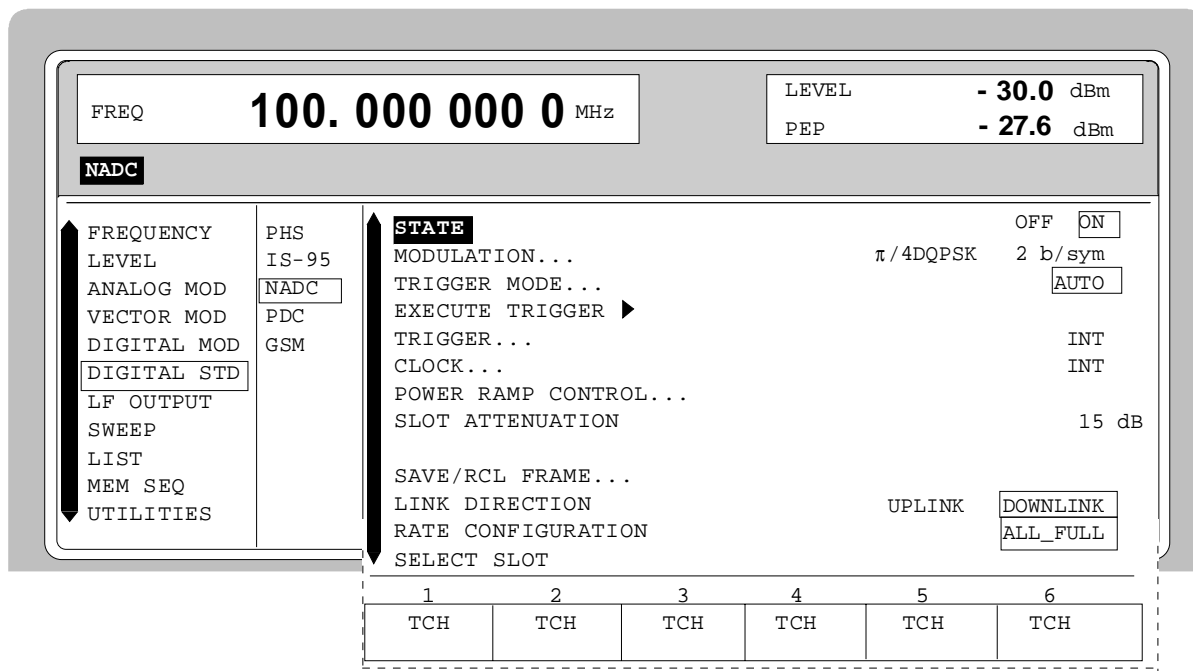

Fig. 2-176 Menu DIGITAL STD - NADC, SMIQ equipped with Modulation Coder SMIQB20 and Data Generator SMIQB11

STATE Switch on/off of Digital Standard NADC modulation. Vector Modulation or Digital Modulation will be switched off automatically.

IEC/IEEE-bus command : SOUR:NADC:STAT ON

MODULATION... Opens a window for setting the modulation parameters.

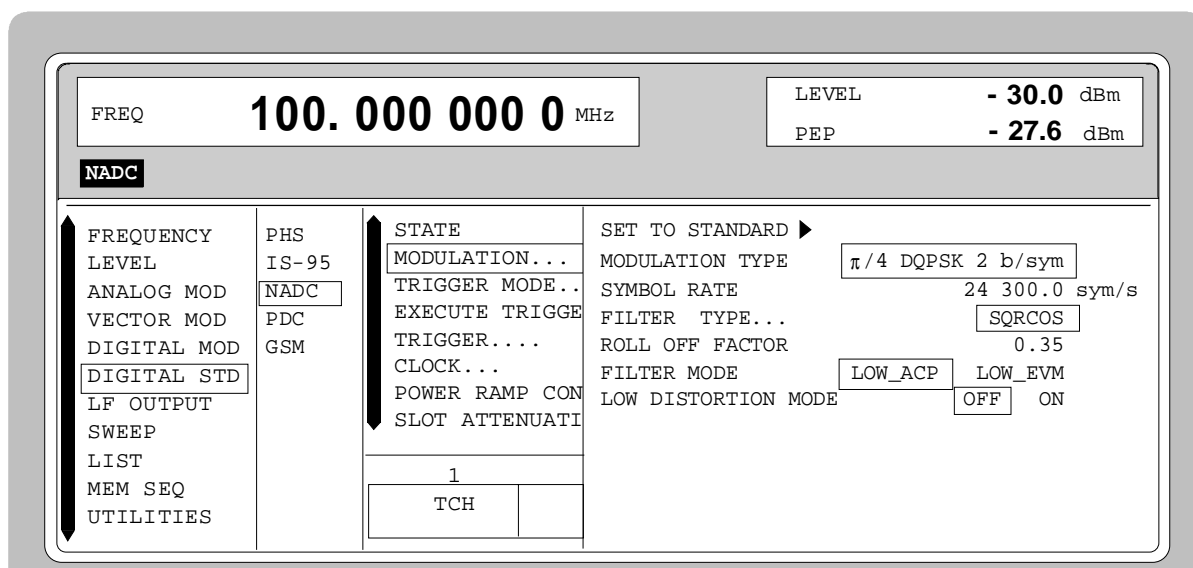

Fig. 2-177 Menu DIGITAL STD - NADC - MODULATION..., SMIQ equipped with Modulation Coder SMIQB20 and Data Generator SMIQB11

(MODULATION...)	SET TO STANDARD ►	Sets the subsequent modulation parameters to the values predefined by the standard.
	MODULATION TYPE	Displays the modulation type.
	SYMBOL RATE	Input value for the symbol clock. 24.3 ksymbol/s are preset. IEC/IEEE-bus : SOUR:NADC:SRAT 24.31KHZ
	FILTER	Selection of baseband filter. A selection between Nyquist filters COS, SQRCOS or a user-defined filter USER (cf. Section Digital Modulation) is possible. IEC/IEEE-bus : SOUR:NADC:FILT:TYPE COS
	ROLL OFF FACTOR	Input value for the roll-off factor. IEC/IEEE-bus : SOUR:NADC:FILT:PAR 0.35
	FILTER MODE	Selection of filter mode. LOW_ACP Filter for minimum <u>A</u> djacent <u>C</u> hannel <u>P</u> ower. IEEE : SOUR:NADC:FILT:MODE LACP LOW_EVM Filter for minimum vector error. IEEE : SOUR:NADC:FILT:MODE LEVM
	LOW DISTORTION	Switch on/off of low-distortion mode.. After switch-on, the level of the IQ baseband signals is reduced by 3 dB. In some cases, this might reduce undesired intermodulation products. OFF is normally the more favourable setting. IEC/IEEE-bus command : SOUR:NADC:LDIS OFF
TRIGGER MODE...		Opens a window for selecting the trigger mode.
	AUTO	The NADC signals are continuously transmitted in the activated slots. IEC/IEEE-bus : SOUR:NADC:SEQ AUTO
	RETRIG	The NADC signals are continuously transmitted in the activated slots. A trigger event causes a restart. IEC/IEEE-bus : SOUR:NADC:SEQ RETR
	ARMED_AUTO	The NADC signal generation does not start until a trigger event has occurred. The unit then automatically switches over to the AUTO mode and can no longer be triggered. IEC/IEEE-bus : SOUR:NADC:SEQ AAUT
	ARMED_RETRIG	The NADC signal generation does not start until a trigger event has occurred. The unit then automatically switches over to the RETRIG mode. Each new trigger event causes a restart. IEC/IEEE-bus : SOUR:NADC:SEQ ARET

EXECUTE TRIGGER ▶ Executes a trigger even to start the NADC signal generation.
IEC/IEEE-bus command :TRIG:DM:IMM

TRIGGER... Opens a window for selecting the trigger source, for configuring the trigger output signals and for setting the time delay of an external trigger signal.

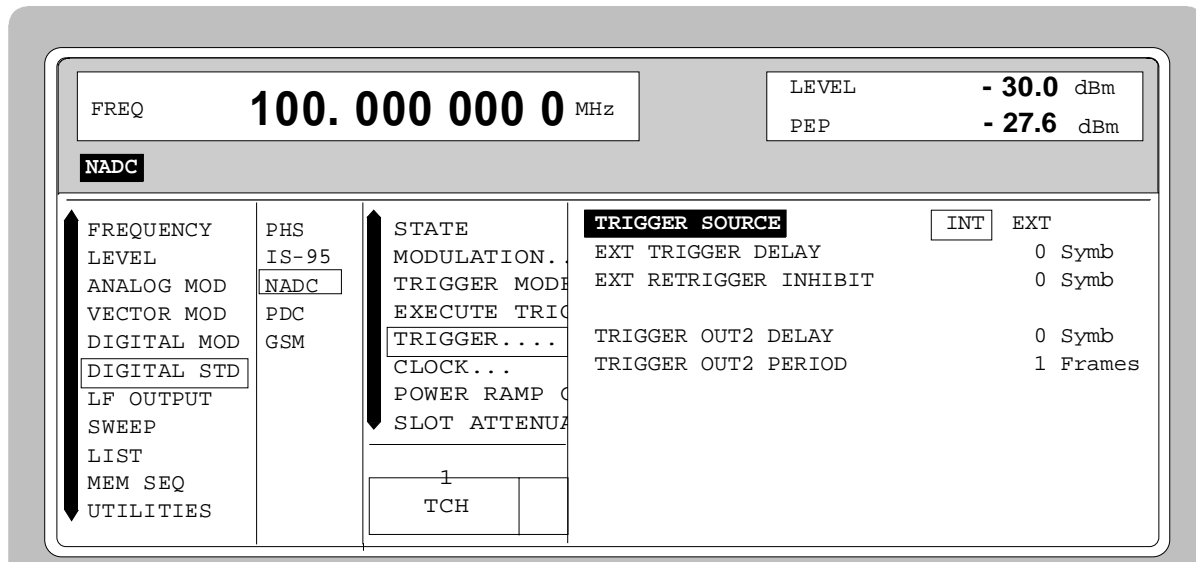

Fig. 2-178 Menu DIGITAL STD - NADC_TRIGGER..., SMIQ equipped with Modulation Coder SMIQB20 and Data Generator SMIQB11

(TRIGGER...)	TRIGGER SOURCE	<p>Selection of trigger source.</p> <p>EXT The NADC signal generation is started by the active slope of an external trigger signal. The polarity, the trigger threshold and the input resistance of the TRIGIN input can be modified in menu DIGITAL MOD - EXT INPUTS.</p> <p>INT A trigger event can be executed by EXECUTE TRIGGER ▶.</p> <p>IEC/IEEE-bus : SOUR:NADC:TRIG:SOUR EXT</p>
	EXT TRIGGER DELAY	<p>Setting the number of symbols by which an external trigger signal is delayed before it starts the NADC signal generation. This is used for setting the time synchronization between the the SMIQ and the DUT.</p> <p>IEC/IEEE-bus : SOUR:NADC:TRIG:DEL 3</p>

(TRIGGER...)	EXT RETRIGGER INHIBIT	<p>Setting the number of symbols for which a restart is inhibited after a trigger event. With TRIGGER MODE RETRIG selected, each new trigger signal restarts the NADC signal generation. This restart can be inhibited for the entered number of symbols.</p> <p>Example: The entry of 1000 symbols causes new trigger signals to be ignored for the duration of 1000 symbols after a trigger event</p> <p>IEC/IEEE-bus : SOUR:NADC:TRIG:INH 1000</p>
	TRIGGER OUT 2 DELAY	<p>Input value of delay of trigger signal at TRIGOUT 2 output compared with beginning of frame.</p> <p>IEC/IEEE-bus : SOUR:NADC:TRIG:OUTP:DEL 2</p>
	TRIGGER OUT2 PERIOD	<p>Input value of output signal period at TRIGOUT 2 output given in frames.</p> <p>IEC/IEEE-bus : SOUR:NADC:TRIG:OUTP:PER 1</p>

CLOCK... Opens a window for selecting the clock source and for setting a delay.

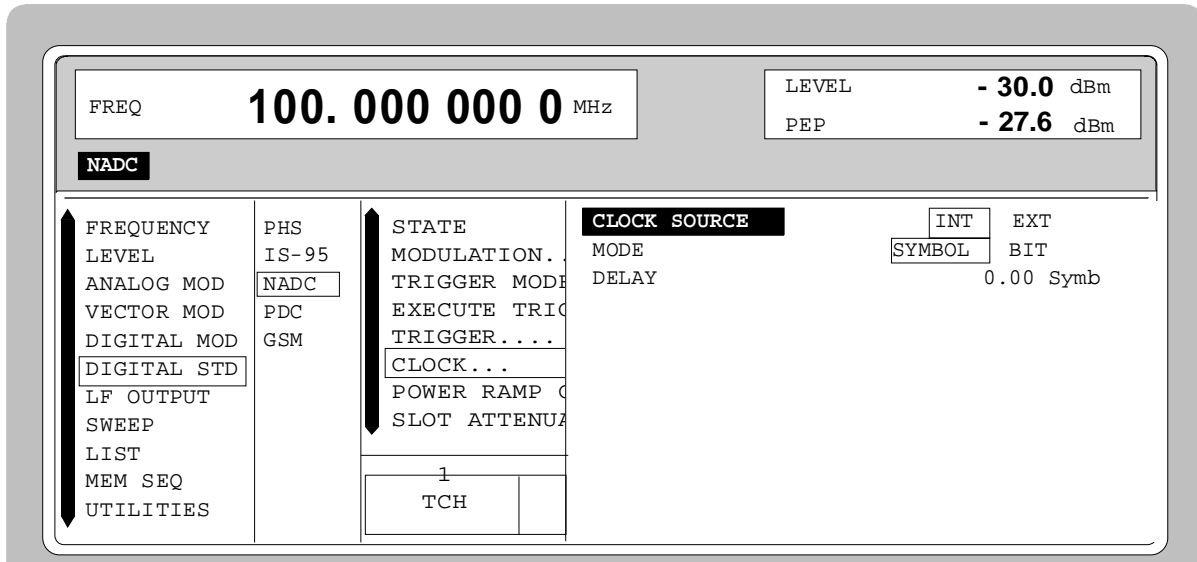

Fig. 2-179 Menu DIGITAL STD - NADC - CLOCK..., SMIQ equipped with Modulation Coder SMIQB20 and Data Generator SMIQB11

(CLOCK...)	CLOCK SOURCE	Selection of clock source. INT SMIQ uses internally generated clock signals. EXT An external symbol clock or bit clock is fed in at connectors SYMBOL CLOCK or BIT CLOCK. The clock synthesizer on the modulation coder is synchronized to this clock. The symbol rate has to be set with an accuracy of ± 1 %. The polarity, the trigger threshold and the input resistance of the clock inputs can be modified in menu DIGITAL MOD - EXT INPUTS. IEC/IEEE-bus command : SOUR : NADC : CLOC : SOUR INT
	MODE	Selection of clock for external clock signal. SYMBOL The external clock has to be a symbol clock. BIT The external clock has to be a bit clock. IEC/IEEE-bus command : SOUR : NADC : CLOC : MODE SYMB
	DELAY	Setting the delay of generated modulation signal to an external clock. This can be used, for example, for synchronization with a second unit to achieve time synchronization between the modulation signals of the two units. IEC/IEEE-bus command : SOUR : NADC : CLOC : DEL 0.5

POWER RAMP CONTROL... Opens a window for setting the envelope control, especially for the rising and falling ramp at the beginning and end of a slot.

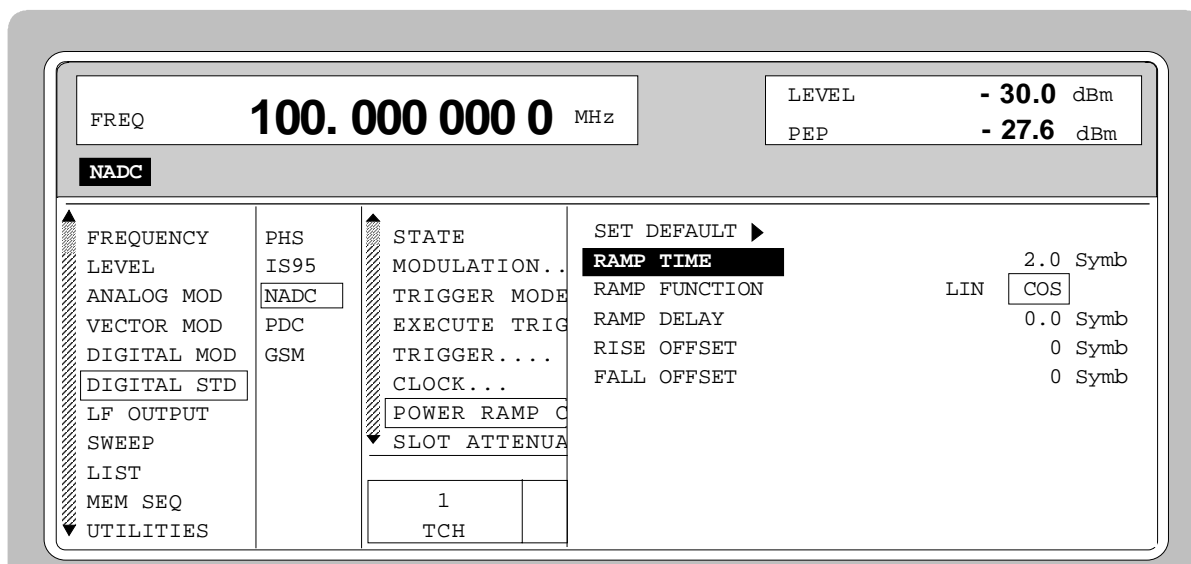

Fig. 2-180 Menu DIGITAL STD - NADC - POWER RAMP CONTROL... , SMIQ equipped with Modulation Coder SMIQB20 and Data Generator SMIQB11

(POWER RAMP CONTROL...)	SET DEFAULT ►	Resets the subsequent parameters to the factory-set values. IEC/IEEE-bus : SOUR : NADC : PRAM : PRES
	RAMP TIME	Input value for the rise and fall time of the envelope at the beginning or end of a slot. The time is set in units of symbol period. IEC/IEEE-bus : SOUR : NADC : PRAM : TIME 0.25
	RAMP FUNCTION	Selection of shape of rising and falling ramp for envelope control. LIN Linear ramp function. COS Cosine function. A more favourable spectrum than that of the LIN function is obtained. IEC/IEEE-bus : SOUR : NADC : PRAM : SHAP LIN
	RAMP DELAY	Input value for a shift of the envelope characteristic to the modulated signal. A positive value causes a delay of the envelope. The values are set in the units of the symbol length. IEC/IEEE-bus : SOUR : NADC : PRAM : DEL 0.1
	RISE OFFSET	Input value for a positive or negative offset of the rising ramp of the envelope at the beginning of a slot. IEC/IEEE-bus : SOUR : NADC : PRAM : ROFF -1
	FALL OFFSET	Input value for a positive or negative offset of the falling ramp of the envelope at the end of a slot. IEC/IEEE-bus : SOUR : NADC : PRAM : LOFF 1
SLOT ATTENUATION	Input value for the level reduction in dB of all active slots whose SLOT LEVEL was set to ATTEN. Menu SELECT SLOT allows the slots to be determined whose level is to be reduced.	IEC/IEEE-bus command : SOUR : NADC : SLOT : ATT 40 DB

SAVE/RCL FRAME... Opens a window for saving and loading a frame configuration. Loading a frame affects all parameters that can be set under SELECT SLOT.

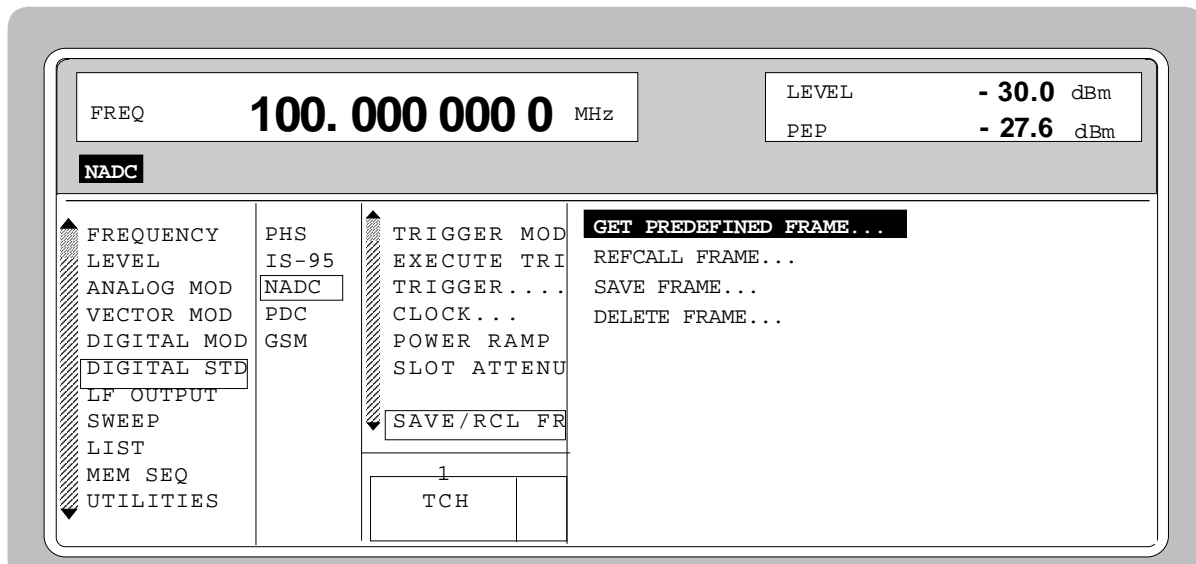

Fig. 2-181 Menu DIGITAL STD - NADC - SAVE/RCL FRAME, SMIQ equipped with Modulation Coder SMIQB20 and Data Generator SMIQB11

- (SAVE/RCL FRAME...) GET PREDEFINED FRAME...** Loads a factory-set frame configuration.
 DN_TCH Downlink traffic channels in all slots.
 UP1TCH Uplink traffic channels in slot 1
 IEC/IEEE-bus : SOUR:NADC:FLIS:LOAD "dn_tch"

- RECALL FRAME** Loads a frame configuration saved by the user.
 IEC/IEEE-bus : SOUR:NADC:FLIS:LOAD "name"

- SAVE FRAME** Saves a user-defined frame configuration.
 IEC/IEEE-bus : SOUR:NADC:FLIS:STOR "name"

- DELETE FRAME** Deletes a frame configuration saved by the user.
 IEC/IEEE-bus : SOUR:NADC:FLIS:DEL "name"

- LINK DIRECTION** Selection between UPLINK and DOWNLINK. Depending on this selection, various burst types are offered under SELECT SLOT.
 IEC/IEEE-bus command : SOUR:NADC:LINK UP

RATE CONFIGURATION...

Opens a window for determining which slots in the frame are to be configured as half-rate and full-rate channels. Full-rate channels occupy two slots in a frame, the second slot is fully determined by the configuration of the first slot. The following eight combinations can be selected:

Selection	Full-rate slots	Half-rate slots
ALL HALF	-	1, 2, 3, 4, 5, 6
FULL 1	1 + 4	2, 3, 5, 6
FULL 2	2 + 5	1, 3, 4, 6
FULL 3	3 + 6	1, 2, 4, 5
FULL 1+2	1 + 4 and 2 + 5	3, 6
FULL 1+3	1 + 4 and 3 + 6	2, 5
FULL 2+3	2 + 5 and 3 + 6	1, 4
ALL FULL	1 + 4 and 2 + 5 and 3 + 6	-

IEC/IEEE-bus command : SOUR:NADC:RCON AHAL

SELECT SLOT...

Selection of one of 6 possible slots. The number depends on the setting under RATE CONFIGURATION. When selecting the slot, a window is opened in which the data contents belonging to this slot can be defined. The content of the window depends on whether an UPLINK or DOWNLINK was selected under LINK DIRECTION.

If the cursor is placed onto a slot in the diagram, it may be switched on and off by pressing one of the unit keys (toggle function).

Menu selection: BURST TYPE = TCH

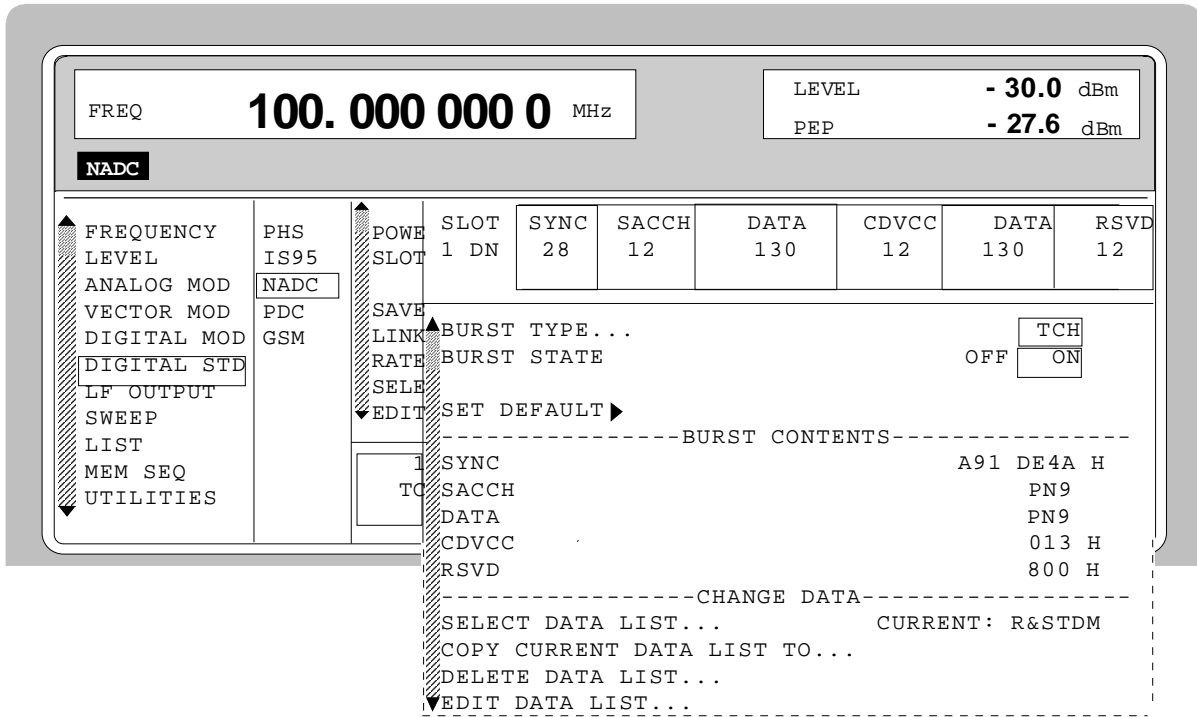

Fig. 2-182 Menu DIGITAL STD - NADC - SELECT SLOT, LINK DIRECTION = DOWNLINK, SMIQ equipped with Modulation Coder SMIQB20 and Data Generator SMIQB11

(SELECT SLOT...) TCH	BURST TYPE	Selection of burst type used to configure the selected slot. TCH Traffic channel burst IEC/IEEE-bus : SOUR:NADC:SLOT2:TYPE TCH
	SLOT LEVEL (UPLINK only)	Selection of level for selected slot. OFF Maximum attenuation IEC/IEEE : SOUR:NADC:SLOT2:LEV OFF FULL The level corresponds to the value indicated on the SMIQ LEVEL display. IEC/IEEE : SOUR:NADC:SLOT2:LEV FULL ATTEN The level is reduced by the value set under SLOT ATTENUATION. IEC/IEEE : SOUR:NADC:SLOT2:LEV ATT
	BURST STATE (DOWNLINK only)	Substitute for parameter SLOT LEVEL for DOWNLINK. ON The burst contents defined in the data fields are sent in the selected slot. IEC/IEEE-bus : SOUR:NADC:SLOT2:LEV FULL OFF Only 1s will be sent. IEC/IEEE-bus : SOUR:NADC:SLOT2:LEV OFF Parameter SLOT LEVEL is omitted since the NADC base station in downlink always sends with the same power in each slot.
	SET DEFAULT ►	Resets the subsequent parameters to the factory-set values. IEC/IEEE-bus command : SOUR:NADC:SLOT8: PRES
	G (UPLINK only)	Display of data contents in the 6 bit data field "Guard" in hexadecimal form.
	R (UPLINK only)	Display of data contents in the 6 bit data field "Ramp".
	DATA	Selection of data source for DATA fields. These fields are regarded as a continuous field, ie a pseudo-random sequence is fully continued from one DATA field to the next. The following data sources are available: PN.. PRBS data according to CCITT with periods between 2^9-1 and $2^{23}-1$. IEEE : SOUR:NADC:SLOT3:DATA PN15 DLIST Data from a programmable data list. IEEE : SOUR:NADC:SLOT3:DATA DLIS SERDATA Data from data input SER DATA. IEEE : SOUR:NADC:SLOT3:DATA SDAT

(SELECT SLOT...) TCH	SYNC	<p>Input value for the 28 bit sync word in hexadecimal form. Depending on the selected slot, the following sync words are predefined according to the NADC standard:</p> <p>SLOT 1 A91DE4A SLOT 2 A9D127A SLOT 3 C7E3C0C SLOT 4 342C3F3 SLOT 5 13E23D1 SLOT 6 DC2EC1D</p> <p>IEC/IEEE-bus : SOUR:NADC:SLOT2:SYNC A91EE4A</p>
	SACCH	<p>Selection of data source for SACCH field (Slow Associated Control Channel).</p> <p>PN.. PRBS data according to CCITT with periods between 2^9-1 and $2^{23}-1$. IEEE : SOUR:NADC:SLOT3:SACC PN15</p> <p>DLIST Data from a programmable data list. IEEE : SOUR:NADC:SLOT3:SACC DLIS</p> <p>SERDATA Data from data input SER DATA. IEEE : SOUR:NADC:SLOT3:SACC SDAT</p>
	CDVCC	<p>Input value for the 12 bit "Coded digital verification color code" field in hexadecimal form. SMIQ does not perform any coding but directly accepts the input data. 013 hex. is preset. This corresponds to a value of 1 for the uncoded colour code DVCC.</p> <p>IEC/IEEE-bus : SOUR:NADC:SLOT2:CDVC #HFFF</p>
	RSVD (DOWNLINK only)	<p>Input value for the 12 bit "Reserved" field in hexadecimal form.</p> <p>IEC/IEEE-bus : SOUR:NADC:SLOT2:CDVC #HFFF</p>
	SELECT DATA LIST...	<p>Opens a window for selecting a stored data list or for generating a new list.</p>
	COPY CURRENT DATA LIST TO...	<p>Stores the current data list under a different name.</p>
	DELETE DATA LIST...	<p>Deletes a data list.</p>
	EDIT DATA LIST...	<p>Opens a window for editing a data list bit-by-bit. The available storage capacity and the length of the current list is displayed in parameters FREE and LEN (see also Section List Editor).</p> <p>COPY Copies a list range FILL Fills the range with filler pattern INSERT Inserts a list range at a different position of the list DELETE Deletes a list range EDIT/VIEW Edits or views the list</p>

Menu selection: BURST TYPE = ALL_DATA

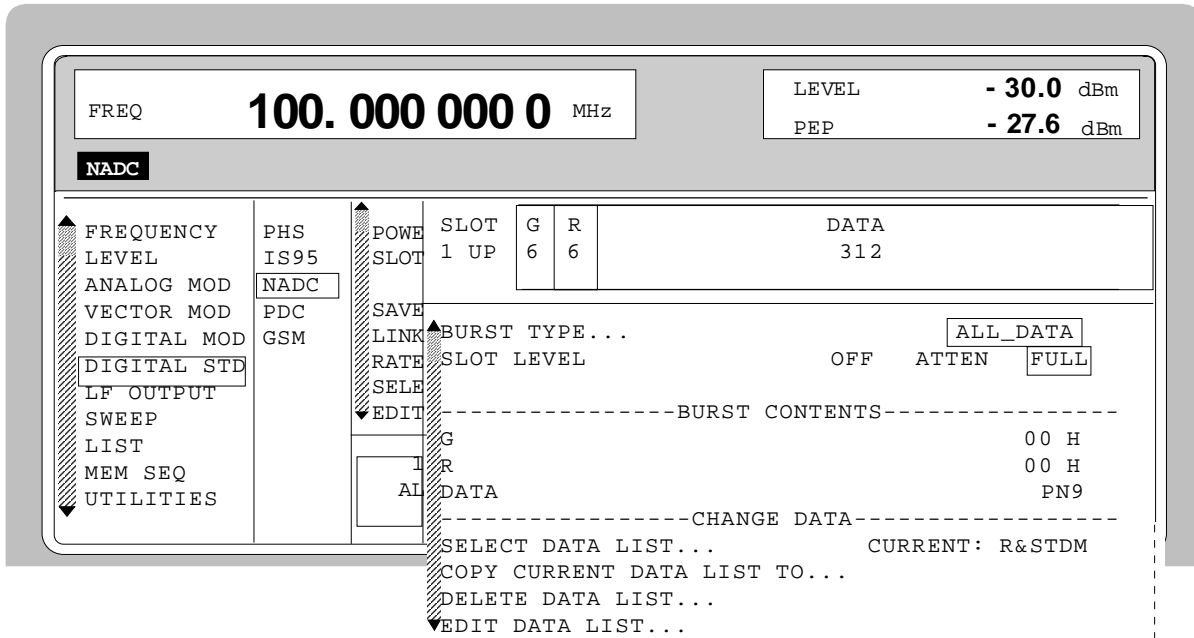

Fig. 2-183 Menu DIGITAL STD - NADC - SELECT SLOT, LINK DIRECTION = UPLINK, SMIQ equipped with Modulation Coder SMIQB20 and Data Generator SMIQB11

<p>(SELECT SLOT...) ALL_DATA</p>	<p>BURST TYPE</p>	<p>Selection of burst type used to configure the selected slot.</p> <p>ALL DATA Burst type for testing with freely programmable data contents</p> <p>IEC/IEEE-bus : SOUR:NADC:SLOT2:TYPE ADAT</p>
<p>SLOT LEVEL (UPLINK only)</p>	<p>SLOT LEVEL</p>	<p>Selection of level for selected slot.</p> <p>OFF Maximum attenuation</p> <p>IEC/IEEE : SOUR:NADC:SLOT2:LEV OFF</p> <p>FULL The level corresponds to the value indicated on the SMIQ LEVEL display.</p> <p>IEC/IEEE : SOUR:NADC:SLOT2:LEV FULL</p> <p>ATTEN The level is reduced by the value set under SLOT ATTENUATION.</p> <p>IEC/IEEE : SOUR:NADC:SLOT2:LEV ATT</p>
<p>BURST STATE (DOWNLINK only)</p>	<p>BURST STATE</p>	<p>Substitute for parameter SLOT LEVEL for LINK DIRECTION = DOWNLINK.</p> <p>ON The burst contents defined in the data fields are sent in the selected slot.</p> <p>OFF Only 1s will be sent.</p> <p>Parameter SLOT LEVEL is omitted since the NADC base station in downlink always sends with the same power in each slot.</p> <p>IEC/IEEE-bus command : SOUR:NADC:SLOT2:LEV FULL</p>
<p>G (UPLINK only)</p>	<p>G</p>	<p>Display of data contents in the 6 bit data field "Guard" in hexadecimal form.</p>

(SELECT SLOT...) R Display of data contents in the 6 bit data field "Ramp".
ALL_DATA (UPLINK only)

DATA Selection of data source for DATA fields. These fields are regarded as a continuous field, ie a pseudo-random sequence is fully continued from one DATA field to the next. The following data sources are available:

PN.. PRBS data according to CCITT with periods between 2^9-1 and $2^{23}-1$.
 IEEE : SOUR:NADC:SLOT3:DATA PN15

DLIST Data from a programmable data list.
 IEEE : SOUR:NADC:SLOT3:DATA DLIS

SERDATA Data from data input SER DATA.
 IEEE : SOUR:NADC:SLOT3:DATA SDAT

Parameter **SELECT DATA LIST...** to **EDIT DATA LIST...** see menu selection BURST TYPE = TCH

Menu selection: BURST TYPE = SHORT (only available with LINK DIRECTION = UPLINK)

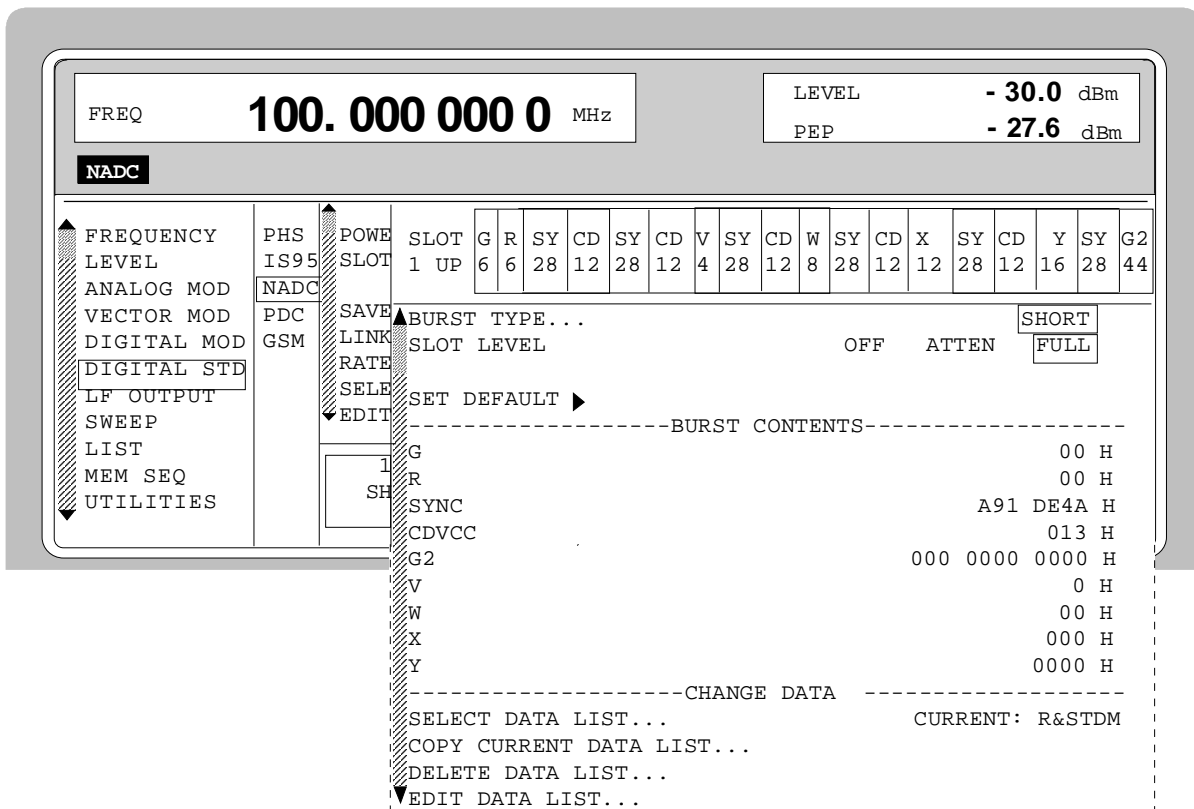

Fig. 2-184 Menu DIGITAL STD - NADC - SELECT SLOT, SMIQ equipped with Modulation Coder SMIQB20 and Data Generator SMIQB11

(SELECT SLOT...) BURST TYPE Selection of burst type used to configure the selected slot.
SHORT Shortened Burst
 (UPLINK ONLY) IEC/IEEE-bus : SOUR:NADC:SLOT2:TYPE SHOR

<p>(SELECT SLOT...) SHORT (UPLINK ONLY)</p>	<p>SLOT LEVEL</p>	<p>Selection of level for selected slot.</p> <p>OFF Maximum attenuation IEC/IEEE : SOUR:NADC:SLOT2:LEV OFF</p> <p>FULL The level corresponds to the value indicated on the SMIQ LEVEL display. IEC/IEEE : SOUR:NADC:SLOT2:LEV FULL</p> <p>ATTEN The level is reduced by the value set under SLOT ATTENUATION. IEC/IEEE : SOUR:NADC:SLOT2:LEV ATT</p>
	<p>SET DEFAULT ►</p>	<p>Resets the subsequent parameters to the factory-set values. IEC/IEEE-bus command : SOUR:NADC:SLOT8 PRES</p>
	<p>G</p>	<p>Display of data contents in the 6 bit data field "Guard" in hexadecimal form.</p>
	<p>R</p>	<p>Display of data contents in the 6 bit data field "Ramp" in hexadecimal form..</p>
	<p>SYNC</p>	<p>Input value for the sync word in hexadecimal form. Depending on the selected slot, the following sync words are predefined according to the NADC standard:</p> <p>SLOT 1 A91DE4A SLOT 2 A9D127A SLOT 3 C7E3C0C SLOT 4 342C3F3 SLOT 5 13E23D1 SLOT 6 DC2EC1D IEC/IEEE-bus : SOUR:NADC:SLOT2:SYNC A91EE4A</p>
	<p>CDVCC</p>	<p>Input value for the 12 bit "Coded digital verification color code" field in hexadecimal form. SMIQ does not perform any coding but directly accepts the input data. 013 hex. is preset. This corresponds to a value of 1 for the uncoded colour code DVCC. IEC/IEEE-bus : SOUR:NADC:SLOT2:CDVC #HFFF</p>
	<p>V, W, X, Y</p>	<p>Display of data contents of other data fields that are predefined by the NADC standard.</p>
	<p>G2</p>	<p>Display of data contents in the second "Guard" in hexadecimal form.</p>

Parameter **SELECT DATA LIST...** to **EDIT DATA LIST...** see menu selection BURST TYPE = TCH

2.17 Digital Standard PDC

With the options Modulation Coder (SMIQB20) and Data Generator (SMIQB11) provided, modulation signals according to the Japanese PDC standard¹ can be generated. PDC is a TDMA standard for cellular mobile radio networks.

SMIQ can generate both the transmit signal of a base station (BS) and the transmit signal of a mobile station (MS). Transmission from BS to MS is called "downlink", "uplink" being used for transmission in the opposite direction.

Each TDMA frame consists of 6 slots. The 6 slots can be configured for both full rate and half rate mode. For half rate, the data content for each of the 6 slots can be defined separately by means of a slot editor whereas in the full rate mode 2 slots for example slot 1 and 4 are combined in a frame. The settings for the first slot are then automatically used for the assigned second slot. Each slot can be switched on or off. Moreover, a defined intermediate level can be set for uplink slots.

A burst type has to be defined to configure a slot. The following burst types can be selected:

- TCH a traffic channel burst with a different structure for uplink and downlink,
- SYNC a burst type for simulation of a sync channel,
- VOX a burst type which is only available in uplink for simulating a communication channel in speech intervals,
- ALL_DATA burst type for test purposes with freely programmable data contents in the selected slot.

For TCH and VOX bursts, SMIQ supports the generation of superframes with a length of 18 frames. The frame position of the so-called "housekeeping channel" RCH can be set in the superframe. According to the standard, the beginning of the superframe is marked by a special sync word in the SYNC data field of the first slot.

The following internal modulation sources are available:

- different PRBS generators with a sequence length between 2^9-1 and $2^{23}-1$ and
- data lists, ie freely programmable data sequences from the data generator memory.

For generating the PDC signals, SMIQ inserts the modulation data continuously (in real time) into the selected slots. Using a digital signal processor the data generator generates a data sequence with modulation data and control signals for envelope control.

The data generator in SMIQ generates a data stream which is converted into IQ signals in the modulation coder. According to the PDC standard, the modulation type is $\pi/4$ DQPSK at a symbol rate of 21 ksymbol/s and $\sqrt{\text{COS}}$ filtering. Symbol rate and filtering can be changed in SMIQ.

¹ Personal Digital Cellular Telecommunication System, RCR STD-27 D

2.17.1 Sync and Trigger Signals

The data generator generates a data sequence with modulation data, control signals for envelope control, and synchronization signals.

When TRIGGER MODE AUTO is selected, the PDC signal generation is started automatically.

This start can also be activated by an external trigger signal (TRIGGER MODE ARMED_AUTO) which allows a synchronous sequence for BER measurements to be carried out on receivers.

A trigger signal can be fed via the TRIGIN input at connector PAR DATA. The active slope of a trigger signal applied there executes a trigger event.

PDC signal generation at a frame or a super frame limit is started after a trigger event. Data from data lists are inserted into the selected slots starting from the first bit. PRBS generators start with the set initialization status.

Signal generation either starts immediately after the active slope of the trigger signal or after a settable number of symbols (EXT TRIGGER DELAY). Retriggering (RETRIG) can be inhibited for a settable number of symbols (EXT RETRIGGER INHIBIT).

A trigger event can be executed manually or via the IEC/IEEE bus using EXECUTE TRIGGER.

When a trigger event is executed, a trigger signal is output at the TRIGOUT 3 output of SMIQ.

SMIQ also generates the following sync signals:

- a frame clock at TRIGOUT 1 output,
- a frame or multiframe clock at TRIGOUT 2 output with settable position in the frame,
- the symbol clock and the bit clock.

A clock synthesizer on the modulation coder generates the symbol clock and the bit clock in SMIQ. All the clock signals are synchronized to the 10-MHz reference of SMIQ. The symbol clock is available at connector SYMBOL CLOCK and the bit clock at connector BIT CLOCK. If required, the clock synthesizer in SMIQ can be synchronized to an external symbol or bit clock.

The clock signal is selected in the menu via CLOCK-CLOCK SOURCE EXT.

To allow for a trouble-free synchronization of the clock synthesizer first apply the external clock and set the correct symbol rate at SMIQ. Then switch CLOCK SOURCE from INT to EXT.

Note: *The set symbol rate should not differ by more than 1% from the symbol rate of the external signal.*

2.17.2 PN Generators as Internal Data Source

Independent PN generators (Pseudo Noise) can be selected for each slot as data source for data fields DATA, SACCH, RCH and SI. These PN generators provide pseudo-random bit sequences of different length or period. That is why they are also called PRBS generators (Pseudo Random Binary Sequence). Data sequences are sequences of maximum length which are generated by means of feedback shift registers.

The following figure gives an example of a 9 bit generator with feedbacks after register 4 and 0 (output).

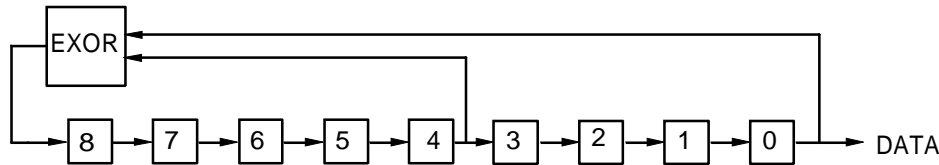

The pseudo-random sequence of a PRBS generator is clearly defined by the number of registers and the feedback. The following table describes all PRBS generators available:

Table 2-30 PRBS generators for PDC

PRBS generator	Length in bits	Feedback after
9 bit	$2^9 - 1 = 511$	Register 4, 0
11 bit	$2^{11} - 1 = 2047$	Register 2, 0
15 bit	$2^{15} - 1 = 32767$	Register 1, 0
16 bit	$2^{16} - 1 = 65535$	Register 5, 3, 2, 0
20 bit	$2^{20} - 1 = 1048575$	Register 3, 0
21 bit	$2^{21} - 1 = 2097151$	Register 2, 0
23 bit	$2^{23} - 1 = 8388607$	Register 5, 0

PN generators PN9,11,15,20 and PN23 are configured according to CCITT Rec. 0.151/152/153. The output sequence is inverted for generators PN15 and PN23.

The start value of the PN generators is different in the slots and equals

$$\text{start value} = 1 + 14 \text{ hex} \times \text{slot number}$$

Example: PN9 generator in slot 1 with start value 15hex = 10101 binary.

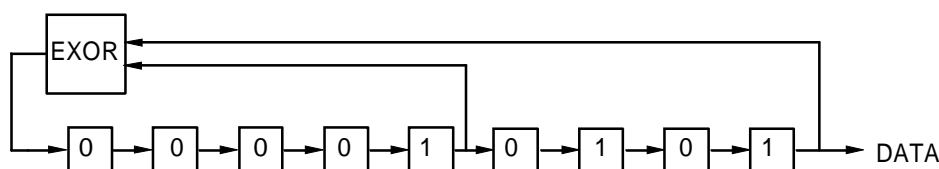

The resulting output sequence is 1010100000010100101011110010 etc.

2.17.3 Lists as Internal Data Source

A freely programmable memory on the data generator serves as internal data source for the data fields of the slots. The data are managed in so-called lists. A list editor allows to select, copy, modify and delete data lists (DATA LIST).

The list editor is available via menu DIGITAL-MOD - SOURCE....

2.17.4 External Modulation Data

External data can (only) be applied via the SERDATA interface. A selection of SERDATA as data source is only possible for a single data field of a slot. For further information on the characteristics of the SERDATA interface see Annex A.

To ensure that the external data bits are assigned to specific positions in the data field of the selected slot and that they are reproducible, the buffer of the RS-232 transmitter and receiver has to be deleted. A triggered start has to follow.

The following setting sequence is required in the DIGITAL STD - PDC menu:

1. Carry out desired settings in menu.
2. Select data source SERDATA for the data field of the slot using SELECT SLOT -
3. Make connection to external data source, but do not yet start external data source.
4. Switch off digital standard using STATE - OFF.
5. Set TRIGGER MODE ARMED_AUTO.
In this state, SMIQ is ready for reception, but discards data that are read in via SERDATA.
6. Switch on digital standard with STATE ON.
7. Start external data source.
The read-in data are written into the receiving buffer. Only if this buffer is filled can SMIQ react to a trigger event.
8. Activate trigger event. Signal generation is thus started at a frame limit. The first bit received via SERDATA is put to the first bit position in the selected data field.

2.17.5 Menu DIGITAL STANDARD - PDC

Menu DIGITAL STD - PDC provides access to settings for generating PDC signals.

Menu selection: DIGITAL STD - PDC

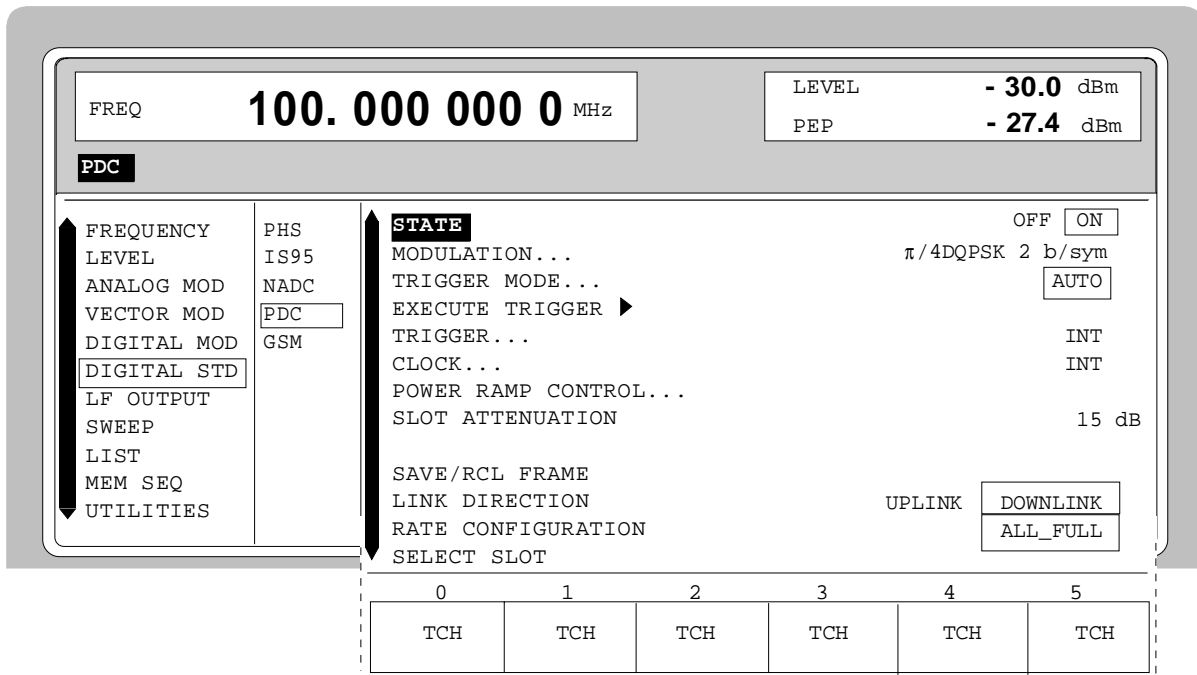

Fig. 2-185 Menu DIGITAL STD - PDC, SMIQ equipped with Modulation Coder SMIQB20 and Data Generator SMIQB11

STATE Switch on/off of Digital Standard PDC modulation. Vector Modulation or Digital Modulation will be switched off automatically.

IEC/IEEE-bus command : SOUR:PDC:STAT ON

MODULATION... Opens a window for setting the modulation parameters.

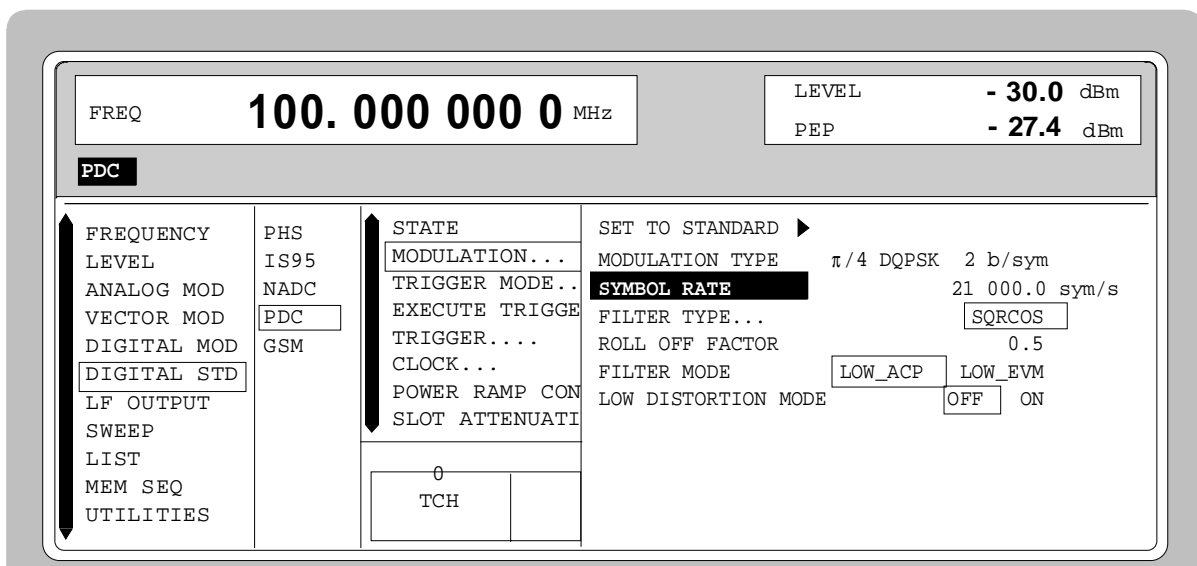

Fig. 2-186 Menu DIGITAL STD - PDC - MODULATION..., SMIQ equipped with Modulation Coder SMIQB20 and Data Generator SMIQB11

(MODULATION...)	SET TO STANDARD ►	Sets the subsequent modulation parameters to the values predefined by the standard.
	MODULATION TYPE	Displays the modulation type.
	SYMBOL RATE	Input value for the symbol clock. 21 ksymbol/s are preset. IEC/IEEE-bus : SOUR:PDC:SRAT 21.1KHZ
	FILTER	Selection of baseband filter. A selection between Nyquist filters COS, SQRCOS or a user-defined filter USER (cf. Section Digital Modulation) is possible. IEC/IEEE-bus : SOUR:PDC:FILT:TYPE COS
	ROLL OFF FACTOR	Input value for the roll-off factor. IEC/IEEE-bus : SOUR:PDC:FILT:PAR 0.51
	FILTER MODE	Selection of filter mode. LOW_ACP Filter for minimum <u>A</u> djacent <u>C</u> hannel <u>P</u> ower. IEC : SOUR:PDC:FILT:MODE LACP LOW_EVM Filter for minimum vector error. IEC : SOUR:PDC:FILT:MODE LEVM
	LOW DISTORTION	Switch on/off of low-distortion mode.. After switch-on, the level of the IQ baseband signals is reduced by 3 dB. In some cases, this might reduce undesired intermodulation products. OFF is normally the more favourable setting. IEC/IEEE-bus command : SOUR:PDC:LDIS OFF
TRIGGER MODE...		Opens a window for selecting the trigger mode.
	AUTO	The PDC signals are continuously transmitted in the activated slots. IEC/IEEE-bus : SOUR:PDC:SEQ AUTO
	RETRIG	The PDC signals are continuously transmitted in the activated slots. A trigger event causes a restart. IEC/IEEE-bus : SOUR:PDC:SEQ RETR
	ARMED_AUTO	The PDC signal generation does not start until a trigger event has occurred. The unit then automatically switches over to the AUTO mode and can no longer be triggered. IEC/IEEE-bus : SOUR:PDC:SEQ AAUT
	ARMED_RETRIG	The PDC signal generation does not start until a trigger event has occurred. The unit then automatically switches over to the RETRIG mode. Each new trigger event causes a restart. IEC/IEEE-bus : SOUR:PDC:SEQ ARET

EXECUTE TRIGGER ▶

Executes a trigger even to start the PDC signal generation.

IEC/IEEE-bus command :TRIG:DM:IMM

TRIGGER...

Opens a window for selecting the trigger source, for configuring the trigger output signals and for setting the time delay of an external trigger signal.

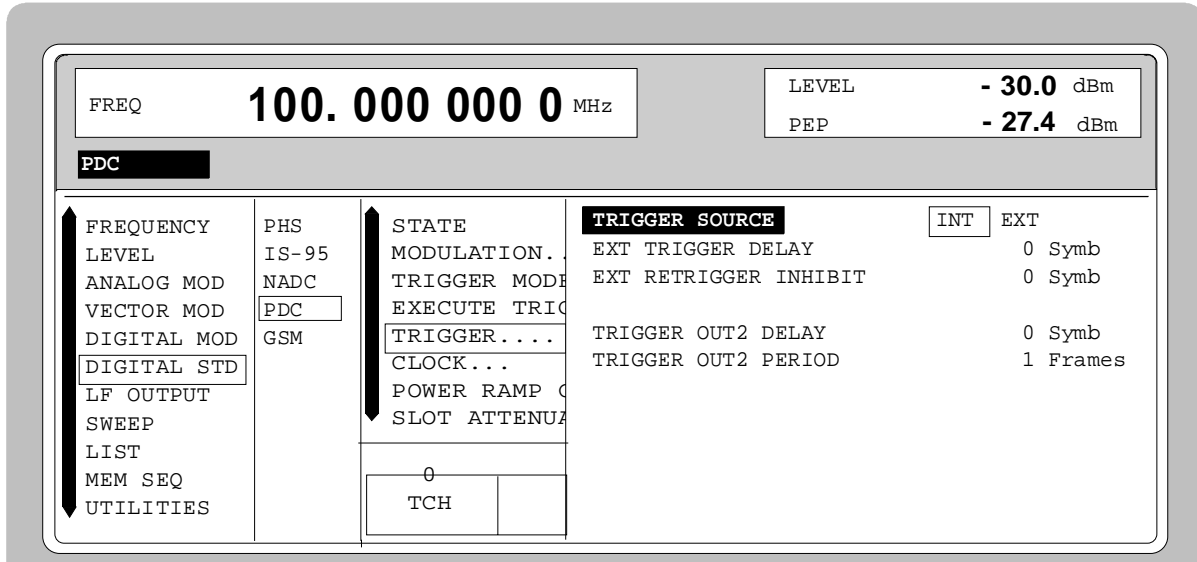

Fig. 2-187 Menu DIGITAL STD - PDC_TRIGGER..., SMIQ equipped with Modulation Coder SMIQB20 and Data Generator SMIQB11

(TRIGGER...)

TRIGGER SOURCE

Selection of trigger source.

EXT The PDC signal generation is started by the active slope of an external trigger signal. The polarity, the trigger threshold and the input resistance of the TRIGIN input can be modified in menu DIGITAL MOD - EXT INPUTS.

INT A trigger event is executed by EXECUTE TRIGGER ▶.

IEC/IEEE-bus : SOUR:PDC:TRIG:SOUR EXT

EXT TRIGGER DELAY

Setting the number of symbols by which an external trigger signal is delayed before it starts the PDC signal generation.

This is used for setting the time synchronization between the SMIQ and the DUT.

IEC/IEEE-bus : SOUR:PDC:TRIG:DEL 3

(TRIGGER...)	EXT RETRIGGER INHIBIT	<p>Setting the number of symbols for which a restart is inhibited after a trigger event. With TRIGGER MODE RETRIG selected, each new trigger signal restarts the PDC signal generation. This restart can be inhibited for the entered number of symbols.</p> <p>Example: The entry of 1000 symbols causes new trigger signals to be ignored for the duration of 1000 symbols after a trigger event</p> <p>IEC/IEEE-bus : SOUR:PDC:TRIG:INH 1000</p>
	TRIGGER OUT 2 DELAY	<p>Input value of delay of trigger signal at TRIGOUT 2 output compared with beginning of frame.</p> <p>IEC/IEEE-bus : SOUR:PDC:TRIG:OUTP:DEL 2</p>
	TRIGGER OUT2 PERIOD	<p>Input value of output signal period at TRIGOUT 2 output given in frames.</p> <p>IEC/IEEE-bus : SOUR:PDC:TRIG:OUTP:PER 1</p>

CLOCK... Opens a window for selecting the clock source and for setting a delay.

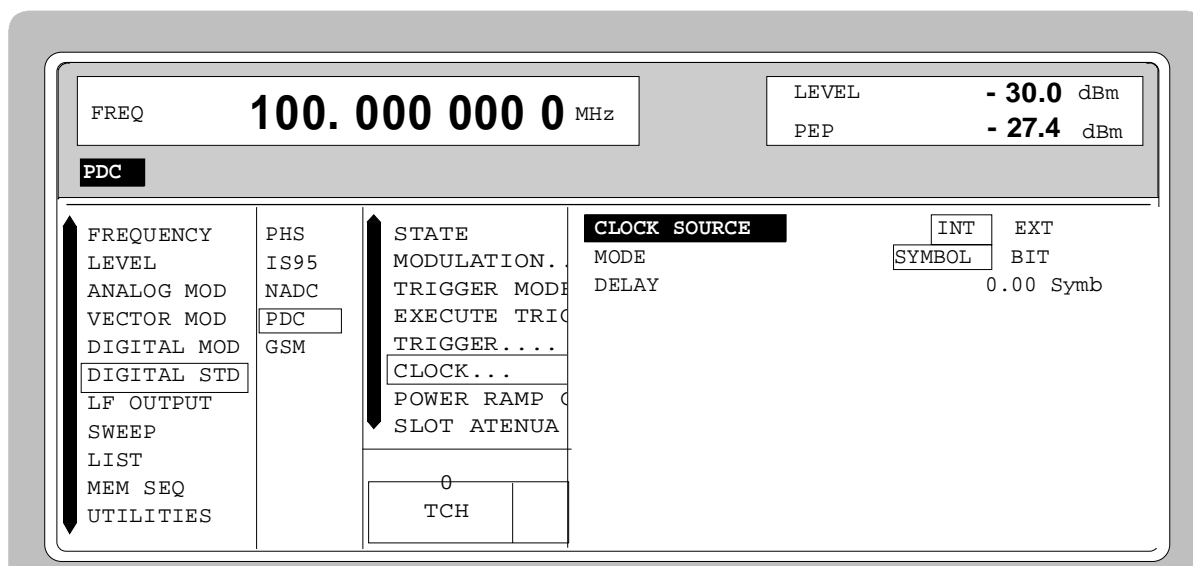

Fig. 2-188 Menu DIGITAL STD - PDC - CLOCK..., SMIQ equipped with Modulation Coder SMIQB20 and Data Generator SMIQB11

- (CLOCK...)** **CLOCK SOURCE** Selection of clock source.
 INT SMIQ uses internally generated clock signals.
 EXT An external symbol clock or bit clock is fed in at connectors SYMBOL CLOCK or BIT CLOCK. The clock synthesizer on the modulation coder is synchronized to this clock.
 The symbol rate has to be set with an accuracy of $\pm 1\%$.
 The polarity, the trigger threshold and the input resistance of the clock inputs can be modified in menu DIGITAL MOD - EXT INPUTS.
 IEC/IEEE-bus command : SOUR:PDC:CLOC:SOUR INT
- MODE** Selection of clock for external clock signal.
 SYMBOL The external clock has to be a symbol clock.
 BIT The external clock has to be a bit clock.
 IEC/IEEE-bus command : SOUR:PDC:CLOC:MODE SYMB
- DELAY** Setting the delay of generated modulation signal to an external clock.
 This can be used, for example, for synchronization with a second unit to achieve time synchronization between the modulation signals of the two units.
 IEC/IEEE-bus command : SOUR:PDC:CLOC:DEL 0.5
- POWER RAMP CONTROL...** Opens a window for setting the envelope control, especially for the rising and falling ramp at the beginning and end of a slot.

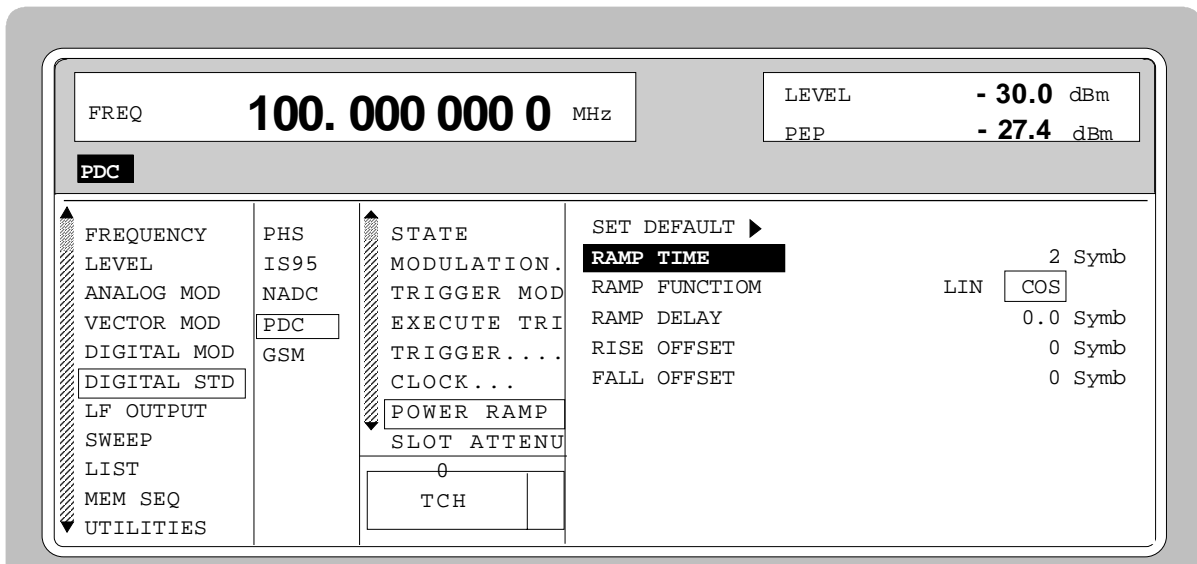

Fig. 2-189 Menu DIGITAL STD - PDC - POWER RAMP CONTROL... , SMIQ equipped with Modulation Coder SMIQB20 and Data Generator SMIQB11

(POWER RAMP CONTROL...)	SET DEFAULT ►	Resets the subsequent parameters to the factory-set values. IEC/IEEE-bus : SOUR:PDC:PRAM:PRES
	RAMP TIME	Input value for the rise and fall time of the envelope at the beginning or end of a slot. The time is set in units of symbol period. IEC/IEEE-bus : SOUR:PDC:PRAM:TIME 0.25
	RAMP FUNCTION	Selection of shape of rising and falling ramp for envelope control. LIN Linear ramp function. COS Cosine function. A more favourable spectrum than that of the LIN function is obtained. IEC/IEEE-bus : SOUR:PDC:PRAM:SHAP LIN
	RAMP DELAY	Input value for a shift of the envelope characteristic to the modulated signal. A positive value causes a delay of the envelope. The values are set in the units of the symbol length. IEC/IEEE-bus : SOUR:PDC:PRAM:DEL 0.1
	RISE OFFSET	Input value for a positive or negative offset of the rising ramp of the envelope at the beginning of a slot. IEC/IEEE-bus : SOUR:PDC:PRAM:ROFF -1
	FALL OFFSET	Input value for a positive or negative offset of the falling ramp of the envelope at the end of a slot. IEC/IEEE-bus : SOUR:PDC:PRAM:LOFF 1
SLOT ATTENUATION	Input value for the level reduction in dB of all active slots whose SLOT LEVEL was set to ATTEN. Menu SELECT SLOT allows the slots to be determined whose level is to be reduced. IEC/IEEE-bus command : SOUR:PDC:SLOT:ATT 15 DB	
SAVE/RCL FRAME...	Opens a window for saving and loading a frame configuration. Loading a frame affects all parameters that can be set under SELECT SLOT.	

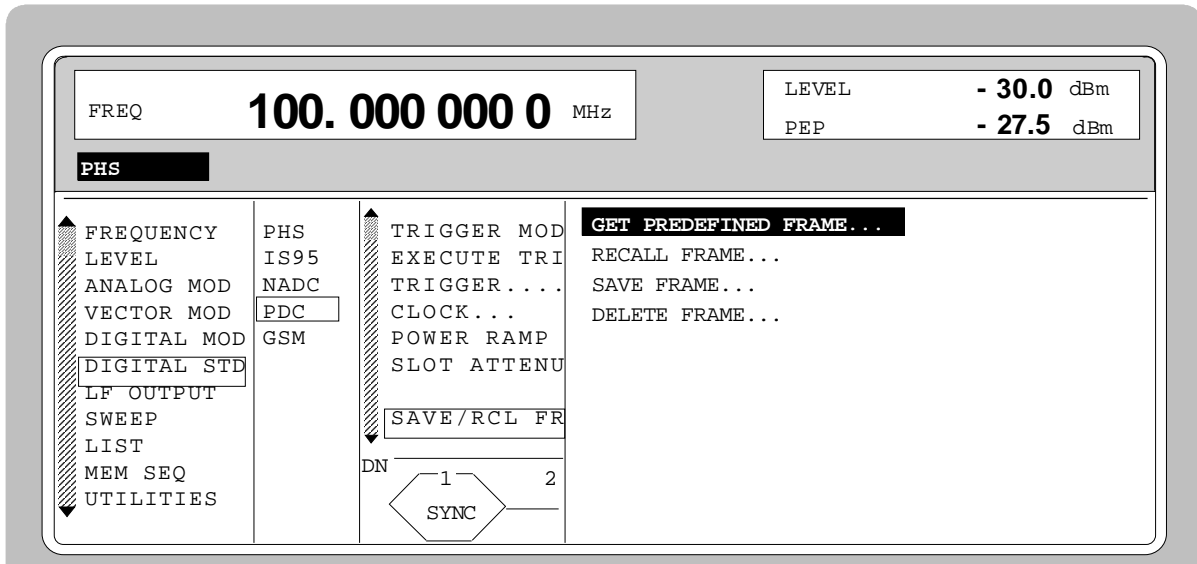

Fig. 2-190 Menu DIGITAL STD - PDC - SAVE/RCL FRAME, SMIQ equipped with Modulation Coder SMIQB20 and Data Generator SMIQB11

(SAVE/RCL FRAME...)	GET PREDEFINED FRAME...	<p>Loads a factory-set frame configuration.</p> <p>DN_TCH Downlink traffic channels in all slots.</p> <p>UP0_TCH Uplink traffic channels in slot 0</p> <p>IEEE : SOUR:PDC:FLIS:PRED:LOAD "dn_tch"</p>
	RECALL FRAME...	<p>Loads a frame configuration saved by the user.</p> <p>IEC/IEEE-bus : SOUR:PDC:FLIS:LOAD "name"</p>
	SAVE FRAME...	<p>Saves a user-defined frame configuration.</p> <p>IEC/IEEE-bus : SOUR:PDC:FLIS:STOR "name"</p>
	DELETE FRAME...	<p>Deletes a frame configuration saved by the user.</p> <p>IEC/IEEE-bus : SOUR:PDC:FLIS:DEL "name"</p>
LINK DIRECTION		<p>Selection between UPLINK and DOWNLINK. Depending on the selection, different burst types are offered under SELECT SLOT.</p> <p>IEC/IEEE-bus command : SOUR:PDC:LINK UP</p>

RATE CONFIGURATION...

Opens a window for determining which slots in the frame are to be configured as half-rate and full-rate channels. Full-rate channels occupy two slots in a frame, the second slot is fully determined by the configuration of the first slot. The following eight combinations can be selected:

Selection	Full-rate slots	Half-rate slots
ALL HALF	keine	0, 1, 2, 3, 4, 5
FULL 1	0 + 3	1, 2, 4, 5
FULL 2	1 + 4	0, 2, 3, 5
FULL 3	2 + 5	0, 1, 3, 4
FULL 1+2	0 + 3 and 1 + 4	2, 5
FULL 1+3	0 + 3 and 2 + 5	1, 4
FULL 2+3	1 + 4 and 2 + 5	0, 3
ALL FULL	0 + 3 and 1 + 4 and 2 + 5	none

IEC/IEEE-bus command SOUR:PDC:RCON AHAL

SELECT SLOT...

Selection of one of 6 possible slots. The number depends on the setting under RATE CONFIGURATION. When selecting the slot, a window is opened in which the data contents belonging to this slot can be defined. The content of the window depends on whether an UPLINK or DOWNLINK was selected under LINK DIRECTION. If the cursor is placed onto a slot in the diagram, it may be switched on and off by pressing one of the unit keys (toggle function).

Menu selection: BURST TYPE = TCH

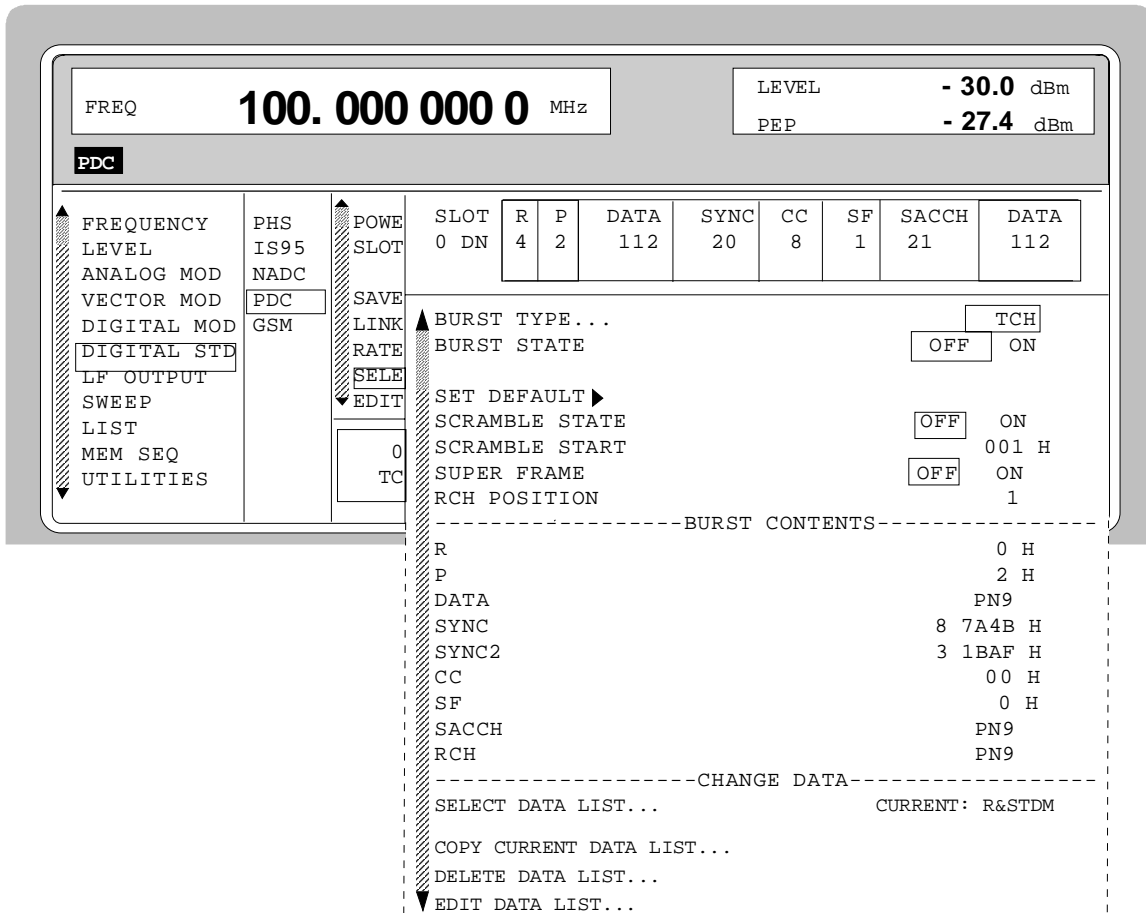

Fig. 2-191 Menu DIGITAL STD - PDC - SELECT SLOT, LINK DIRECTION DOWNLINK, SMIQ equipped with Modulation Coder SMIQB20 and Data Generator SMIQB11

(SELECT SLOT...) TCH	BURST TYPE	<p>Selection of burst type used to configure the selected slot.</p> <p>TCH Traffic channel burst</p> <p>IEC/IEEE-bus : SOUR:PDC:SLOT2:TYPE TCH</p>
	SLOT LEVEL (UPLINK only)	<p>Selection of level for selected slot.</p> <p>OFF Maximum attenuation</p> <p>IEC/IEEE : SOUR:PDC:SLOT2:LEV OFF</p> <p>FULL The level corresponds to the value indicated on the SMIQ LEVEL display.</p> <p>IEC/IEEE : SOUR:PDC:SLOT2:LEV FULL</p> <p>ATTEN The level is reduced by the value set under SLOT ATTENUATION.</p> <p>IEC/IEEE : SOUR:PDC:SLOT2:LEV ATT</p>
	BURST STATE (DOWNLINK only)	<p>Substitute for parameter SLOT LEVEL for downlink.</p> <p>ON The burst contents defined in the data fields are sent in the selected slot.</p> <p>IEC/IEEE-bus : SOUR:PDC:SLOT2:LEV FULL</p> <p>OFF Only 1s will be sent.</p> <p>IEC/IEEE-bus : SOUR:PDC:SLOT2:LEV OFF</p> <p>Parameter SLOT LEVEL is omitted since the NADC base station in downlink always sends with the same power in each slot.</p>
	SET DEFAULT ►	<p>Resets the subsequent parameters to the factory-set values.</p> <p>IEC/IEEE-bus command SOUR:PDC:SLOT8:PRES</p>
	SCRAMBLE	<p>Switch on/off of scrambling function. Scrambling with the continuous scramble sequence from a PN9 generator is applied to the data fields DATA, SF, and SACCH.</p> <p>IEC/IEEE-bus : SOUR:PDC:SLOT2:SCR:STAT ON</p>
	SCRAMBLE START	<p>9 bit input value for initializing the scramble PN9 generator in hexadecimal form. The value 0 is not permissible, 1 is preset. The input field is only displayed if SCRAMBLE is switched on.</p> <p>IEC/IEEE-bus : SOUR:PDC:SLOT2:SCR:STAR #H12</p>
	SUPERFRAME	<p>Switch on/off of the superframe generation. 18 frames form a superframe. If SUPERFRAME is switched on, RCH data instead of SACCH data will be sent in 2 slots. The first of the two RCH blocks is fixed in the first slot of the superframe, the position of the second can be set.</p> <p>IEC/IEEE-bus : SOUR:PDC:SLOT2:SFR:STAT ON</p>

(SELECT SLOT...) **RCH POSITION** Input value for the position of the second RCH block. The input field is only displayed if SUPERFRAME is switched on.
TCH IEC/IEEE-bus : SOUR:PDC:SLOT2:SFR:RCHP 10

R Display of data contents in the 4 bit data field "RAMP" in hexadecimal form.

P Input value of the 2 bit data field "Preamble".
 IEC/IEEE-bus : SOUR:PDC:SLOT2:PRE #H1

DATA Selection of data source for DATA fields. These fields are regarded as a continuous field, ie a pseudo-random sequence is fully continued from one DATA field to the next. The following data sources are available:
PN.. PRBS data according to CCITT with periods between 2^9-1 and $2^{23}-1$.
 IEC/IEEE : SOUR:PDC:SLOT3:DATA PN15
DLIST Data from a programmable data list.
 IEC/IEEE : SOUR:PDC:SLOT3:DATA DLIS
SERDATA Data from data input SER DATA.
 IEC/IEEE : SOUR:PDC:SLOT3:DATA SDAT

SYNC Input value for the 20 bit sync word in hexadecimal form. Depending on the selected slot the LINK DIRECTION, the following sync words are predefined according to the PDC standard:

Slot No.	Downlink Sync Word	Uplink Sync Word
0	87A4B	785B4
1	9D236	62DC9
2	81D75	7E28A
3	A94EA	56B15
4	5164C	AE9B3
5	4D9DE	B2621

According to the standard, the sync words of the uplink are the inverted sync words of the downlink.

IEC/IEEE-bus : SOUR:PDC:SLOT2:SYNC #H62DC8

**(SELECT SLOT...) SYNC2
TCH**

Input value for the 20 bit sync word in the first slot of a superframe in hexadecimal form. This sync word marks the beginning of the superframe. The input field is only displayed if SUPERFRAME is switched on. Depending on the selected slot and the LINK DIRECTION, the following sync words are predefined according to the PDC standard:

Slot No.	Downlink Sync2 Word	Uplink Sync2 Word
0	31BAF	CE450
1	1E56F	E1A90
2	E712C	18ED3
3	FBC1F	043E0
4	8279E	7D861
5	98908	676F7

According to the standard, the sync words of the uplink are the inverted sync words of the downlink.

IEC/IEEE-bus : SOUR:PDC:SLOT2:SYNC #HE2A90

CC

Input value of the 8 bit data field " Color code ".

IEC/IEEE-bus command : SOUR:PDC:SLOT2:CCOD #HFF

SF

Input value of the data field " Steal Flag ".

IEC/IEEE-bus command : SOUR:PDC:SLOT2:SF #H0

SACCH

Selection of data source for SACCH field (Slow Associated Control Channel).

PN.. PRBS data according to CCITT with periods between 2^9-1 and $2^{23}-1$.

IEC/IEEE : SOUR:PDC:SLOT3:SACC PN15

DLIST Data from a programmable data list.

IEC/IEEE : SOUR:PDC:SLOT3:SACC DLIS

SERDATA Data from data input SER DATA.

IEC/IEEE : SOUR:PDC:SLOT3:SACC SDAT

RCH

Selection of data source for the RCH data field. RCH data replace SACCH data in certain slots of a superframe. The input field is only displayed if SUPERFRAME is switched on.

PN.. PRBS data according to CCITT with periods between 2^9-1 and $2^{23}-1$.

IEC/IEEE : SOUR:PDC:SLOT3:RCH PN15

DLIST Data from a programmable data list.

IEC/IEEE : SOUR:PDC:SLOT3:RCH DLIS

SERDATA Data from data input SER DATA.

IEC/IEEE : SOUR:PDC:SLOT3:RCH SDAT

<p>(SELECT SLOT...) TCH</p>	<p>G (UPLINK only)</p>	<p>Display of data content in the 6 bit "Guard" field in hexadecimal form.</p>
<p>SELECT DATA LIST...</p>	<p></p>	<p>Opens a window for selecting a stored data list or for generating a new list.</p>
<p>COPY CURRENT DATA LIST TO...</p>	<p></p>	<p>Stores the current data list under a different name.</p>
<p>DELETE DATA LIST...</p>	<p></p>	<p>Deletes a data list.</p>
<p>EDIT DATA LIST...</p>	<p></p>	<p>Opens a window for editing a data list bit-by-bit. The available storage capacity and the length of the current list is displayed in parameters FREE and LEN (see also Section List Editor).</p>
	<p>COPY</p>	<p>Copies a list range</p>
	<p>FILL</p>	<p>Fills the range with filler pattern</p>
	<p>INSERT</p>	<p>Inserts a list range at a different position of the list</p>
	<p>DELETE</p>	<p>Deletes a list range</p>
	<p>EDIT/VIEW</p>	<p>Edits or views the list</p>

Menu selection: BURST TYPE = ALL_DATA

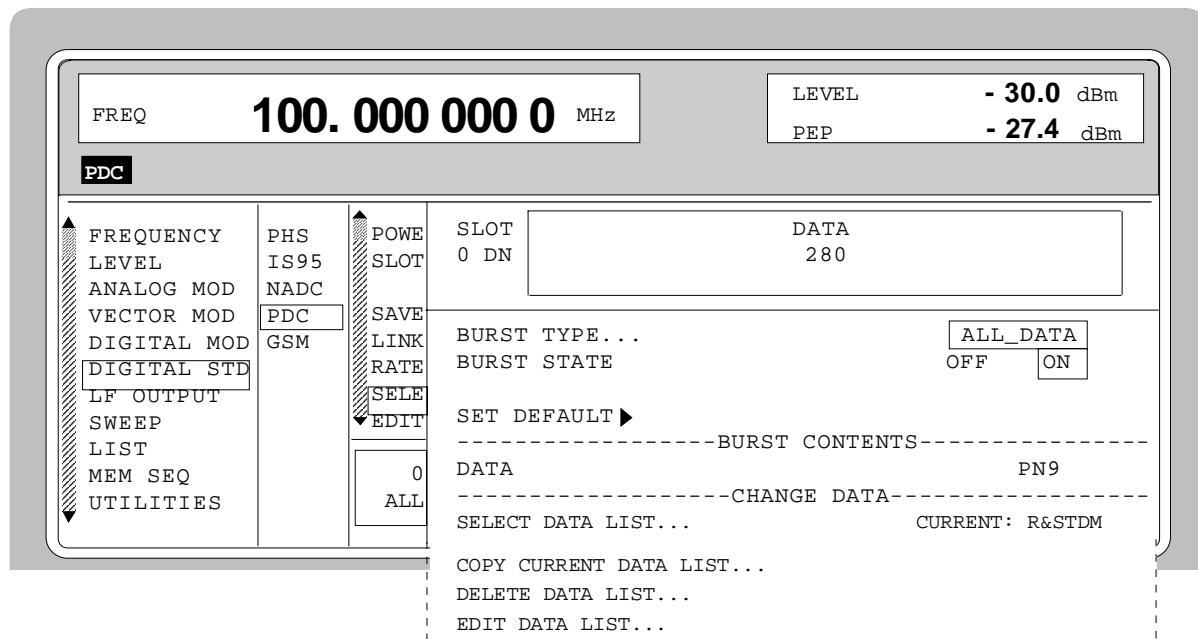

Fig. 2-192 Menu DIGITAL STD - PDC - SELECT SLOT, LINK DIRECTION = DOWNLINK, SMIQ equipped with Modulation Coder SMIQB20 and Data Generator SMIQB11

(SELECT SLOT...) ALL_DATA	BURST TYPE	<p>Selection of burst type used to configure the selected slot.</p> <p>ALL DATA Burst type for testing with freely programmable data contents</p> <p>IEC/IEEE-bus command : SOUR:PDC:SLOT2:TYPE ADAT</p>
	SLOT LEVEL (UPLINK only)	<p>Selection of level for selected slot.</p> <p>OFF Maximum attenuation</p> <p>IEC/IEEE : SOUR:PDC:SLOT2:LEV OFF</p> <p>FULL The level corresponds to the value indicated on the SMIQ LEVEL display.</p> <p>IEC/IEEE : SOUR:PDC:SLOT2:LEV FULL</p> <p>ATTEN The level is reduced by the value set under SLOT ATTENUATION.</p> <p>IEC/IEEE : SOUR:PDC:SLOT2:LEV ATT</p>
	BURST STATE (DOWNLINK only)	<p>Substitute for parameter SLOT LEVEL for downlink.</p> <p>ON The burst contents defined in the data fields are sent in the selected slot.</p> <p>IEC/IEEE-bus : SOUR:PDC:SLOT2:LEV FULL</p> <p>OFF Only 1s will be sent.</p> <p>IEC/IEEE-bus : SOUR:PDC:SLOT2:LEV OFF</p> <p>Parameter SLOT LEVEL is omitted since the NADC base station in downlink always sends with the same power in each slot.</p>
	R (UPLINK only)	<p>Display of data contents in the 6 bit data field "Ramp" in hexadecimal form..</p>
	G (UPLINK only)	<p>Display of data contents in the 6 bit data field "Guard" in hexadecimal form.</p>
	DATA	<p>Selection of data source for DATA fields. These fields are regarded as a continuous field, ie a pseudo-random sequence is fully continued from one DATA field to the next. The following data sources are available:</p> <p>PN.. PRBS data according to CCITT with periods between 2^9-1 and $2^{23}-1$.</p> <p>IEC/IEEE : SOUR:PDC:SLOT3:DATA PN15</p> <p>DLIST Data from a programmable data list.</p> <p>IEC/IEEE : SOUR:PDC:SLOT3:DATA DLIS</p> <p>SERDATA Data from data input SER DATA.</p> <p>IEC/IEEE : SOUR:PDC:SLOT3:DATA SDAT</p>

Parameter **SELECT DATA LIST...** to **EDIT DATA LIST...** see menu selection BURST TYPE = TCH

Menu selection: BURST TYPE = SYNC

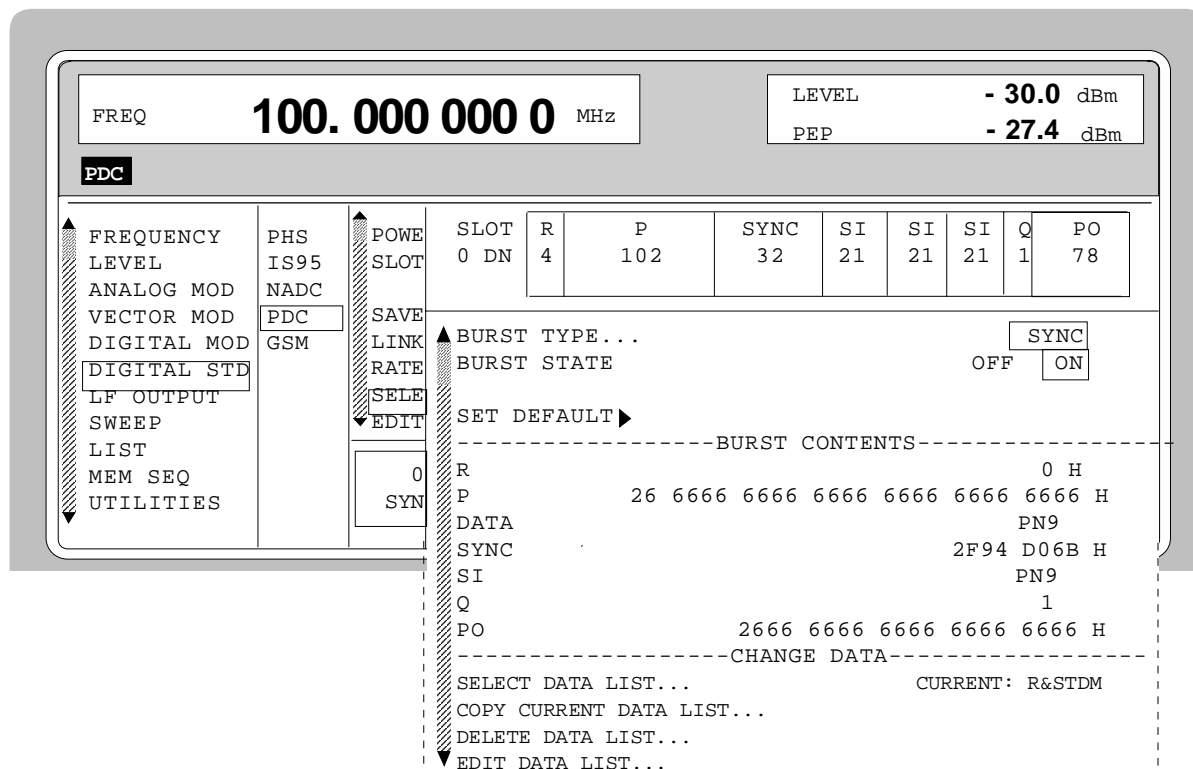

Fig. 2-193 Menu DIGITAL STD - PDC - SELECT SLOT, LINK DIRECTION = DOWNLINK, SMIQ equipped with Modulation Coder SMIQB20 and Data Generator SMIQB11

- (SELECT SLOT...) BURST TYPE** Selection of burst type used to configure the selected slot.
SYNC SHORT Shortened Burst
 IEC/IEEE-bus command : SOUR:PDC:SLOT2:TYPE SYNC
- SLOT LEVEL** Selection of level for selected slot.
 (UPLINK only) OFF Maximum attenuation
 IEC/IEEE : SOUR:PDC:SLOT2:LEV OFF
 FULL The level corresponds to the value indicated on the SMIQ LEVEL display.
 IEC/IEEE : SOUR:PDC:SLOT2:LEV FULL
 ATTEN The level is reduced by the value set under SLOT ATTENUATION.
 IEC/IEEE : SOUR:PDC:SLOT2:LEV ATT
- BURST STATE** Substitute for parameter SLOT LEVEL for downlink.
 (DOWNLINK only) ON The burst contents defined in the data fields are sent in the selected slot.
 OFF Only 1s will be sent.
 Parameter SLOT LEVEL is omitted since the PDC base station in downlink always sends with the same power in each slot.
 IEC/IEEE-bus command : SOUR:PDC:SLOT2:LEV FULL

(SELECT SLOT...) SET DEFAULT ► Resets the subsequent parameters to the factory-set values.
SYNC IEC/IEEE-bus command : SOUR:PDC:SLOT8 PRES

G
 (UPLINK only) Display of data contents in the 54 bit data field "Guard" in hexadecimal form.
 The field is only displayed with link direction UPLINK selected.

R Display of data contents in the 6 bit data field "Ramp".

P Input value of the data field "Preamble" in hexadecimal form. The length of the field is 48 bit with link direction = UPLINK, and 102 bit with DOWNLINK
 IEC/IEEE-bus command : SOUR:PDC:SLOT2:PRE #HFF

SYNC Input value for the 32 bit sync word in hexadecimal form. Depending on the selected slot and the link direction, the following sync words are predefined according to the PDC standard:

Slot No.	Downlink Sync Word	Uplink Sync Word
0	2F94D06B	D06B2F94
1	1D4EE2B1	E2B11D4E
2	70168FE9	8FE97016
3	83527CAD	7CAD8352
4	3678C987	C9873678
5	48D8B727	B72748D8

According to the standard, the sync words of the uplink are the inverted sync words of the downlink.

IEC/IEEE-bus : SOUR:PDC:SLOT2:SYNC #HE2B11D4F

SI Selection of data source for "Sync Information" field. The data in each of the three SI fields are identical

PN.. PRBS data according to CCITT with periods between 2^9-1 and $2^{23}-1$.

IEC/IEEE : SOUR:PDC:SLOT2:SOUR:SI PN15

DLIST Data from a programmable data list.

IEC/IEEE : SOUR:PDC:SLOT2:SOUR:SI DLIS

SERDATA Data from data input SER DATA.

IEC/IEEE : SOUR:PDC:SLOT2:SOUR:SI SDAT

Q Display of the tail bits.

PO
 (DOWNLINK only) Input value for the 78 bit "Postamble" field in hexadecimal form.

IEC/IEEE-bus command : SOUR:PDC:SLOT2:POST #HFF

G2
 (UPLINK only) Display of data contents in the 78 bit "Guard" field in hexadecimal form at the end of the slot.

Parameter **SELECT DATA LIST... to EDIT DATA LIST...** see menu selection BURST TYPE = TCH

Menu selection: BURST TYPE = VOX (only available with LINK DIRECTION = UPLINK)

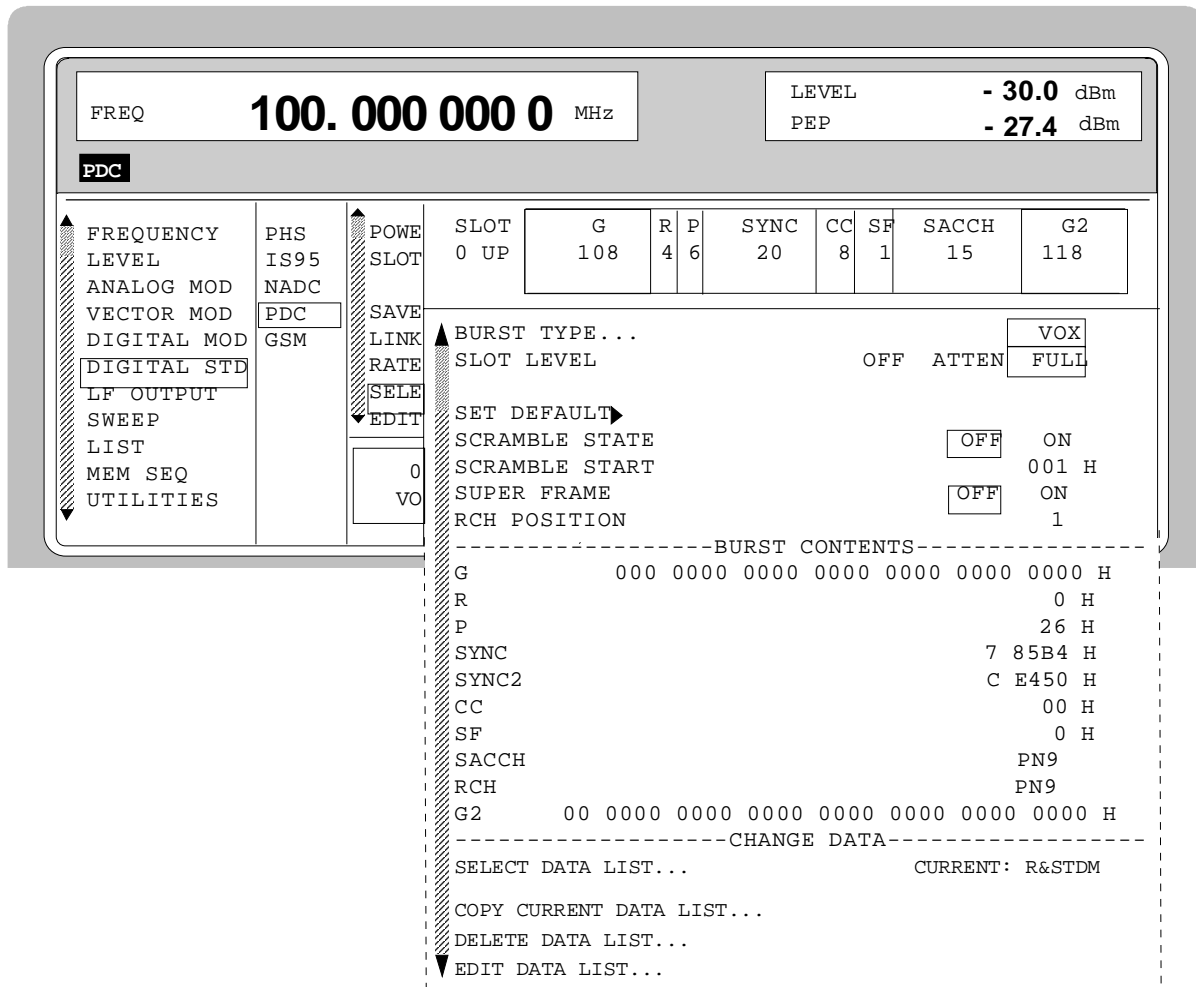

Fig. 2-194 Menu DIGITAL STD - PDC - SELECT SLOT, LINK DIRECTION = UPLINK, SMIQ equipped with Modulation Coder SMIQB20 and Data Generator SMIQB11

- (SELECT SLOT...) BURST TYPE** Selection of burst type used to configure the selected slot. VOX is only available with LINK DIRECTION = UPLINK selected.
- VOX** VOX burst
- (UPLINK ONLY)** IEC/IEEE-bus command : SOUR:PDC:SLOT2:TYPE VOX
-
- SLOT LEVEL** Selection of level for selected slot.
- OFF** Maximum attenuation
- IEC/IEEE : SOUR:PDC:SLOT2:LEV OFF
- FULL** The level corresponds to the value indicated on the SMIQ LEVEL display.
- IEC/IEEE : SOUR:PDC:SLOT2:LEV FULL
- ATTEN** The level is reduced by the value set under SLOT ATTENUATION.
- IEC/IEEE : SOUR:PDC:SLOT2:LEV ATT

- (SELECT SLOT...)** **SET DEFAULT** ► Resets the subsequent parameters to the factory-set values.
VOX
 (UPLINK ONLY) IEC/IEEE-bus command SOUR:PDC:SLOT8 PRES
- SCRAMBLE** Switch on/off of scrambling function. Scrambling with the continuous scramble sequence from a PN9 generator is applied to the data fields SF and SACCH.
 IEC/IEEE-bus : SOUR:PDC:SLOT2:SCR:STAT ON
- SCRAMBLE START** 9 bit input value for initializing the scramble PN9 generator in hexadecimal form. The value 0 is not permissible, 1 is preset. The input field is only displayed if SCRAMBLE is switched on.
 IEC/IEEE-bus : SOUR:PDC:SLOT2:SCR:STAR #H2
- SUPERFRAME** Switch on/off of the superframe generation. 18 frames form a superframe. If SUPERFRAME is switched on, RCH data instead of SACCH data will be sent in 2 slots. The first of the two RCH blocks is fixed in the first slot of the superframe, the position of the second can be set.
 IEC/IEEE-bus : SOUR:PDC:SLOT2:SFR:STAT ON
- RCH POSITION** Input value for the position of the second RCH block. The input field is only displayed if SUPERFRAME is switched on.
 IEC/IEEE-bus : SOUR:PDC:SLOT2:SFR:RCHP 10
- G** Display of data contents in the 108 bit "Guard" field at the beginning of the slot in hexadecimal form.
- R** Display of data contents in the 4 bit data field "RAMP" in hexadecimal form.
- P** Input value of the 26 bit data field "Preamble".
 IEC/IEEE-bus command : SOUR:PDC:SLOT2:PRE #HFF
- SYNC** Input value for the 20 bit sync word in hexadecimal form. Depending on the selected slot, the following sync words are predefined according to the PDC standard:

Slot No.	VOX Sync Word
0	785B4
1	62DC9
2	7E28A
3	56B15
4	AE9B3
5	B2621

IEC/IEEE-bus : SOUR:PDC:SLOT2:SYNC #H72DC9

(SELECT SLOT...) SYNC2
VOX
 (UPLINK ONLY)

Input value for the 20 bit sync word in the first slot of a superframe in hexadecimal form. This sync word marks the beginning of a superframe. The input field is only displayed if SUPERFRAME is switched on. Depending on the selected slot, the following sync words are predefined according to the PDC standard:

Slot No.	VOX Sync2 Word
0	CE450
1	E1A90
2	18ED3
3	043E0
4	7D861

IEC/IEEE-bus command : SOUR:PDC:SLOT2:SYNC E1A91

CC

Input value of the 8 bit data field " Color code ".

IEC/IEEE-bus command : SOUR:PDC:SLOT2:CCOD #HFF

SF

Input value of the data field " Steal Flag ".

IEC/IEEE-bus command : SOUR:PDC:SLOT2:SF #H0

SACCH

Selection of data source for SACCH field (Slow Associated Control Channel).

PN.. PRBS data according to CCITT with periods between 2^9-1 and $2^{23}-1$.

IEC/IEEE : SOUR:PDC:SLOT3:SACC PN15

DLIST Data from a programmable data list.

IEC/IEEE : SOUR:PDC:SLOT3:SACC DLIS

SERDATA Data from data input SER DATA.

IEC/IEEE : SOUR:PDC:SLOT3:SACC SDAT

RCH

Selection of data source for the RCH data field. RCH data replace SACCH data in certain slots of a superframe. The input field is only displayed if SUPERFRAME is switched on.

PN.. PRBS data according to CCITT with periods between 2^9-1 and $2^{23}-1$.

IEC/IEEE : SOUR:PDC:SLOT3:RCH PN9

DLIST Data from a programmable data list.

IEC/IEEE : SOUR:PDC:SLOT3:RCH DLIS

SERDATA Data from data input SER DATA.

IEC/IEEE : SOUR:PDC:SLOT3:RCH SDAT

G2

Display of data contents in the 118 bit "Guard" field at the end of the slot in hexadecimal form. The field is only displayed with LINK DIRECTION = UPLINK selected.

Parameter **SELECT DATA LIST...** to **EDIT DATA LIST...** see menu selection BURST TYPE = TCH

2.18 Digital Standard GSM/EDGE

With the options Modulation Coder (SMIQB20) and Data Generator (SMIQB11) provided, modulation signals according to the GSM standard can be generated. GSM is a TDMA standard for cellular mobile radio networks used worldwide. SMIQ is suitable for use as a signal generator for all GSM types.

With option SMIQB20, the use of GSM and EDGE slots is not limited. GSM/EDGE may also be used with the older modulation coder option (SMIQB10), however in this case GSM and EDGE cannot be mixed.

SMIQ can generate both the transmit signal of a base station (BS) and the transmit signal of a mobile station (MS). Transmission from BS to MS is called "downlink", "uplink" being used for transmission in the opposite direction.

Each TDMA frame consists of 8 slots. Each slot can be switched on or off separately. Moreover, a defined intermediate level can be set.

A burst type has to be defined to configure a slot. The following burst types can be selected:

- NORM the so-called "normal burst",
- DUMMY burst type with a defined data pattern according to GSM standard and
- ALL_DATA burst type for test purposes with freely programmable data contents.
- EDGE the so-called EDGE Normal Burst

The following internal modulation sources are available:

- different PRBS generators with a sequence length between 2^9-1 and $2^{23}-1$ and
- data lists, i.e. freely programmable data sequences from the data generator memory.

For generating the GSM signals, SMIQ inserts the modulation data continuously (in real time) into the selected slots. Using a digital signal processor the data generator generates a data sequence with modulation data and control signals for envelope control.

The data generator in SMIQ generates a data stream which is converted into IQ signals in the modulation coder. According to the GSM standard, the modulation type is GMSK at a symbol rate of 270.833 ksymbol/s and Gauss filtering. The symbol rate can be changed in SMIQ. GFSK with adjustable frequency deviation can be used as a modulation type, too.

The modulation type for EDGE slots is 8PSK, with $3/8\pi$ rotation at a symbol rate of 270.833 ksymbols/s and linear Gauss filter.

2.18.1 Sync and Trigger Signals

The data generator generates a data sequence with modulation data, control signals for envelope control, and synchronization signals.

When TRIGGER MODE AUTO is selected, the GSM signal generation is started automatically.

This start can also be activated by an external trigger signal (TRIGGER MODE ARMED_AUTO) which allows a synchronous sequence for BER measurements to be carried out on receivers.

A trigger signal can be fed via the TRIGIN input at connector PAR DATA. The active slope of a trigger signal applied there executes a trigger event.

GSM signal generation at a frame limit is started after a trigger event. Data from data lists are inserted into the selected slots starting from the first bit. PRBS generators start with the set initialization status.

Signal generation either starts immediately after the active slope of the trigger signal or after a settable number of symbols (EXT TRIGGER DELAY). Retriggering (EXT RETRIG) can be inhibited for a settable number of symbols (EXT RETRIGGER INHIBIT).

A trigger event can be executed manually using EXECUTE TRIGGER or via the IEC/IEEE bus.

When a trigger event is executed, a trigger signal is output at the TRIGOUT 3 output of SMIQ.

SMIQ also generates the following sync signals:

- a slot or frame clock at TRIGOUT 1 output with settable position in the frame,
- a frame or multiframe clock at TRIGOUT 2 output with settable position in the frame,
- the symbol clock and the bit clock.

A clock synthesizer on the modulation coder generates the symbol clock and the bit clock in SMIQ. The two clocks are identical for GSM. All the clock signals are synchronized to the 10-MHz reference of SMIQ. The bit clock is available at connector BIT CLOCK. If required, the clock synthesizer in SMIQ can be synchronized to an external bit clock.

The clock signal is selected in the menu via CLOCK-CLOCK SOURCE EXT.

To allow for a trouble-free synchronization of the clock synthesizer first apply the external clock and set the correct symbol rate at SMIQ. Then switch CLOCK SOURCE from INT to EXT.

Note: *The set symbol rate should not differ by more than 1% from the symbol rate of the external signal.*

2.18.2 PN Generators as Internal Data Source

Independent PN generators (Pseudo Noise) can be selected for each slot as data source for data field DATA. These PN generators provide pseudo-random bit sequences of different length or period. That is why they are also called PRBS generators (Pseudo Random Binary Sequence).

Data sequences are sequences of maximum length which are generated by means of feedback shift registers.

The following figure gives an example of a 9 bit generator with feedbacks after register 4 and 0 (output).

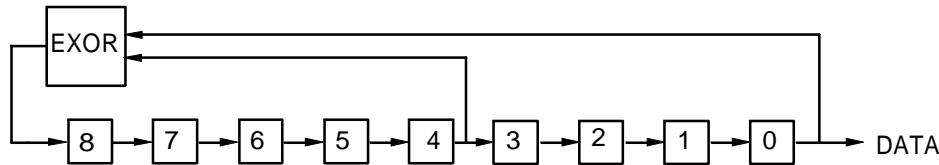

The pseudo-random sequence of a PRBS generator is clearly defined by the number of registers and the feedback. The following table describes all PRBS generators available:

Table 2-31 PRBS generators for GSM

PRBS generator	Length in bits	Feedback after
9 bit	$2^9 - 1 = 511$	Register 4, 0
11 bit	$2^{11} - 1 = 2047$	Register 2, 0
15 bit	$2^{15} - 1 = 32767$	Register 1, 0
16 bit	$2^{16} - 1 = 65535$	Register 5, 3, 2, 0
20 bit	$2^{20} - 1 = 1048575$	Register 3, 0
21 bit	$2^{21} - 1 = 2097151$	Register 2, 0
23 bit	$2^{23} - 1 = 8388607$	Register 5, 0

PN generators PN9,11,15, 20 and PN23 are configured according to CCITT Rec. 0.151/152/153. The output sequence is inverted for generators PN15 and PN23.

The start value of the PN generators is different in the slots and equals

$$\text{start value} = 1 + 14 \text{ hex} \times \text{slot number}$$

Example: PN9 generator in slot 1 with start value 15hex = 10101 binary.

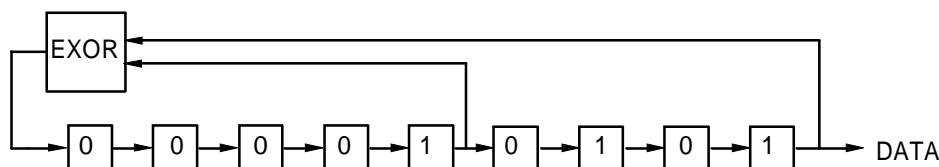

The resulting output sequence is 1010100000010100101011110010 etc.

2.18.3 Lists as Internal Data Source

A freely programmable memory on the data generator serves as internal data source for the data fields of the slots. The data are managed in so-called lists. A list editor allows data lists (DATA LIST) to be selected, copied, modified, and deleted.

The list editor is available via menu DIGITAL-MOD - SOURCE....

2.18.4 External Modulation Data

External data can (only) be applied via the SERDATA interface. A selection of SERDATA as data source is only possible for a single data field of a slot. For further information on the characteristics of the SERDATA interface see Annex A.

To ensure that the external data bits are assigned to specific positions in the data field of the selected slot and that they are reproducible, the buffer of the RS-232 transmitter and receiver has to be deleted. A triggered start has to follow.

The following setting sequence is required in the DIGITAL STD - GSM/EDGE menu:

1. Carry out desired settings in menu.
2. Select data source SERDATA for the data field of the slot using SELECT SLOT -
3. Make connection to external data source, but do not yet start external data source.
4. Switch off digital standard using STATE - OFF.
5. Set TRIGGER MODE ARMED_AUTO.
In this state, SMIQ is ready for reception, but discards data that are read in via SERDATA.
6. Switch on digital standard with STATE ON.
7. Start external data source.
The read-in data are written into the receiving buffer. Only if this buffer is filled can SMIQ react to a trigger event.
8. Activate trigger event. Signal generation is thus started at a frame limit. The first bit received via SERDATA is put to the first bit position in the selected data field.

2.18.5 Menu DIGITAL STANDARD - GSM/EDGE

Menu DIGITAL STD - GSM/EDGE provides access to settings for generating GSM signals.

Menu selection: DIGITAL STD - GSM/EDGE

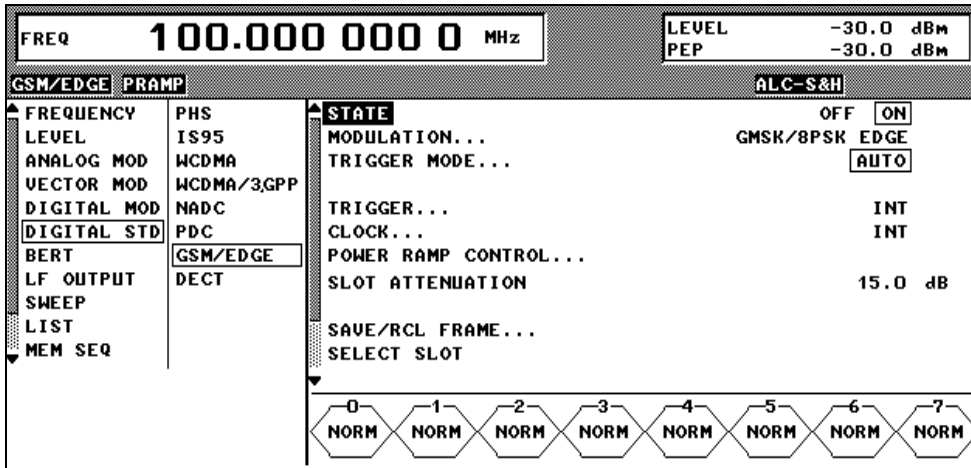

Fig. 2-195 Menu DIGITAL STD - GSM/EDGE, SMIQ equipped with Modulation Coder SMIQB20 and Data Generator SMIQB11

STATE Switch on/off of Digital Standard GSM/EDGE modulation. Vector Modulation or Digital Modulation will be switched off automatically.
IEC/IEEE-bus command SOUR:GSM:STAT ON

MODULATION... Opens a window for setting the modulation parameters.

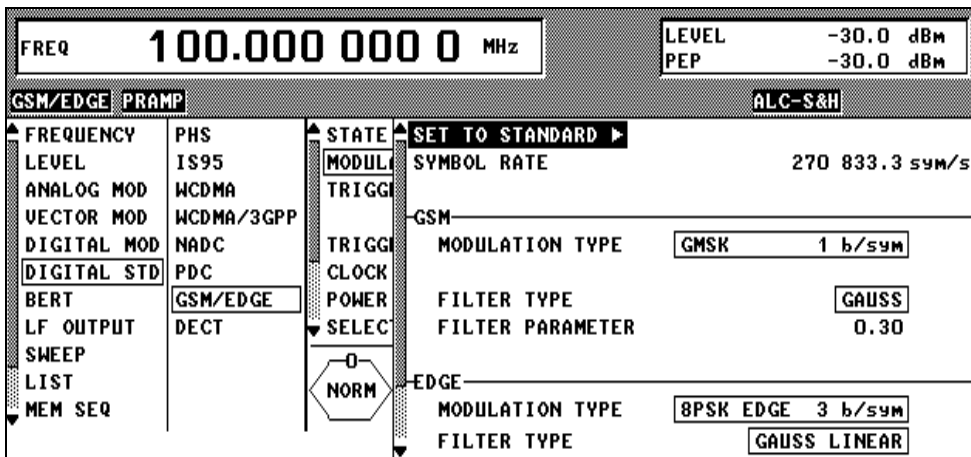

Fig. 2-196 Menu DIGITAL STD - GSM/EDGE - MODULATION..., SMIQ equipped with Modulation Coder SMIQB20 and Data Generator SMIQB11

MODULATION... SET TO STANDARD ► Sets the subsequent modulation parameters to the values predefined by the standard.

SYMBOL RATE Input value for the symbol clock. 270.833 ksymbol/s are preset.
IEC/IEEE-bus : SOUR:GSM:SRAT 270KHZ

(MODULATION...)	<p>The following parameters are used with GSM</p> <p>MODULATION TYPE Opens a window for selection of the modulation type. GMSK Gaussian Minimum Shift Keying GFSK Gaussian filtered Frequency Shift Keying IEC/IEEE-bus SOUR:GSM:FORMat GMSK</p> <p>FSK DEVIATION Input value of deviation with GFSK selected. With GMSK selected, the deviation is fixed to the fourth part of the symbol rate. IEC/IEEE-bus SOUR:GSM:FSK:DEV 67 KHZ</p> <p>FILTER TYPE Display of the baseband filter for GSM.</p> <p>FILTER PARAMETER Input value for the BxT value (Gaussian filter). IEC/IEEE-bus SOUR:GSM:FILT:PAR 0.31</p> <p>The following parameters are used with EDGE</p> <p>MODULATION TYPE The modulation type for EDGE is displayed. It is permanently set to 8PSK EDGE. In contrast to the modulation types for GSM, the one for EDGE has three bits per symbol.</p> <p>FILTER TYPE The filter for EDGE is displayed. It is permanently set to GAUSS LINEAR.</p>
TRIGGER MODE...	<p>Opens a window for selecting the trigger mode.</p> <p>AUTO The GSM signals are continuously transmitted in the activated slots. IEC/IEEE-bus command SOUR:GSM:SEQ AUTO</p> <p>RETRIG The GSM signals are continuously transmitted in the activated slots. A trigger event causes a restart. IEC/IEEE-bus command SOUR:GSM:SEQ RETR</p> <p>ARMED_AUTO The GSM signal generation does not start until a trigger event has occurred. The unit then automatically switches over to the AUTO mode and can no longer be triggered. IEC/IEEE-bus command SOUR:GSM:SEQ AAUT</p> <p>ARMED_RETRIG The GSM signal generation does not start until a trigger event has occurred. The unit then automatically switches over to the RETRIG mode. Each new trigger event causes a restart. IEC/IEEE-bus command SOUR:GSM:SEQ ARET</p>

EXECUTE TRIGGER ▶ Executes a trigger even to start the GSM signal generation.
IEC/IEEE-bus command : TRIG:DM:IMM

TRIGGER... Opens a window for selecting the trigger source, for configuring the trigger output signals and for setting the time delay of an external trigger signal.

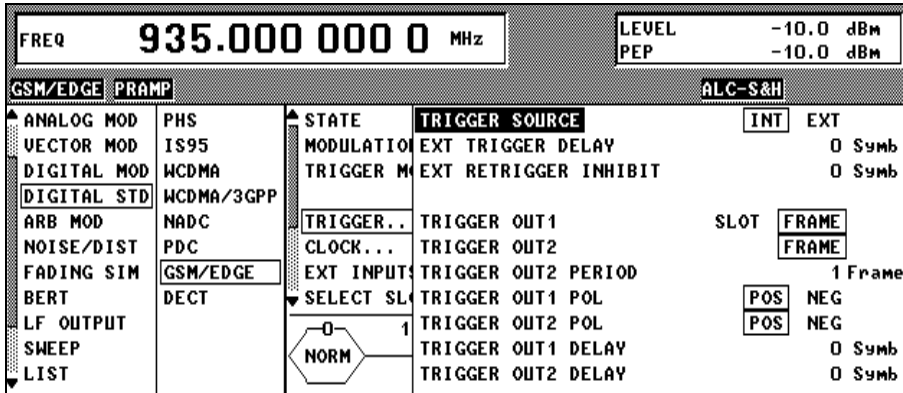

Fig. 2-197 Menu DIGITAL STD - GSM/EDGE_TRIGGER..., SMIQ equipped with Modulation Coder SMIQB20 and Data Generator SMIQB11

(TRIGGER...) **TRIGGER SOURCE** Selection of trigger source.
EXT The GSM signal generation is started by the active slope of an external trigger signal.
INT The polarity, the trigger threshold and the input resistance of the TRIGIN input can be modified in menu DIGITAL MOD - EXT INPUTS.
A trigger event can be executed by EXECUTE TRIGGER ▶.
IEC/IEEE-bus SOUR:GSM:TRIG:SOUR EXT

EXT TRIGGER DELAY Setting the number of symbols by which an external trigger signal is delayed before it starts the GSM signal generation.
This is used for setting the time synchronization between the SMIQ and the DUT.
IEC/IEEE-bus SOUR:GSM:TRIG:DEL 3

(TRIGGER...) **EXT RETRIGGER INHIBIT** Setting the number of symbols for which a restart is inhibited after a trigger event.
With TRIGGER MODE RETRIG selected, each new trigger signal restarts the GSM signal generation. This restart can be inhibited for the entered number of symbols.
Example:
The entry of 1000 symbols causes new trigger signals to be ignored for the duration of 1000 symbols after a trigger event
IEC/IEEE-bus SOUR:GSM:TRIG:INH 1000

TRIGGER OUT 1 Selecting the signal for TRIGOUT 1 output in PARADATA connector.
The times only apply if the default value of 270.833 kpsps for GSM/EDGE is used as the symbol rate in the Modulation menu.

SLOT 0.577 ms e.g. clock
IEC/IEEE-bus command:
: SOUR: GSM: TRIG: OUTP1 SLOT

FRAME 4.615 ms frame clock
IEC/IEEE-bus command:
: SOUR: GSM: TRIG: OUTP1 FRAM

TRIGGER OUT 2 Selecting the signal for TRIGOUT 2 output in PARADATA connector.
The times only apply if the default value of 270.833 kpsps for GSM/EDGE is used as the symbol rate in the Modulation menu.

FRAME 4.615 ms frame clock
IEC/IEEE-bus command:
: SOUR: GSM: TRIG: OUTP2 FRAM

TRIGGER OUT 1/2 DELAY Input value of delay of trigger signal at TRIGOUT 2 output compared with beginning of slot or frame.

IEC/IEEE-bus : SOUR: GSM: TRIG: OUTP: DEL 2

TRIGGER OUT2 PERIOD Input value of output signal period at TRIGOUT 2 output given in frames.

IEC/IEEE-bus : SOUR: GSM: TRIG: OUTP: PER 1

TRIGGER OUT 1/2 POL Selecting the polarity of signals at the TRIGOUT 1 and TRIGOUT 2 outputs in the PARADATA connector.

IEC/IEEE-bus command
: SOUR: GSM: TRIG: OUTP2: POL POS

CLOCK... Opens a window for selecting the clock source and for setting a delay.

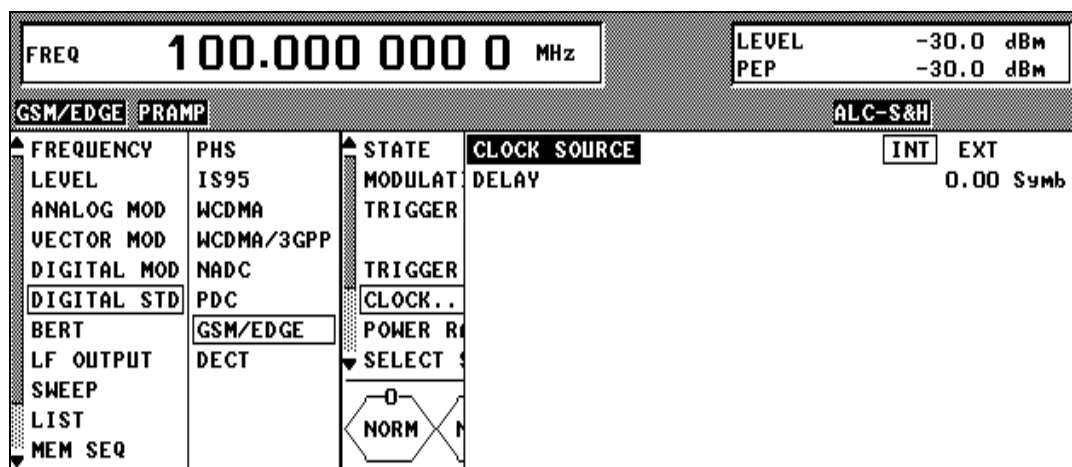

Fig. 2-198 Menu DIGITAL STD - GSM/EDGE - CLOCK..., SMIQ equipped with Modulation Coder SMIQB20 and Data Generator SMIQB11

(CLOCK...) **CLOCK SOURCE** Selection of clock source.

INT SMIQ uses internally generated clock signals.

EXT An external bit clock is fed in at connector BIT CLOCK. The clock synthesizer on the modulation coder is synchronized to this clock.

 The symbol rate has to be set with an accuracy of $\pm 1\%$.

 The polarity, the trigger threshold and the input resistance of the clock inputs can be modified in menu DIGITAL MOD - EXT INPUTS.

IEC/IEEE-bus SOUR:GSM:CLOC:SOUR INT

DELAY Setting the delay of generated modulation signal to an external clock.

 This can be used, for example, for synchronization with a second unit to achieve time synchronization between the modulation signals of the two units.

IEC/IEEE-bus SOUR:GSM:CLOC:DEL 0.5

POWER RAMP CONTROL... Opens a window for setting the envelope control, especially for the rising and falling ramp at the beginning and end of a slot.

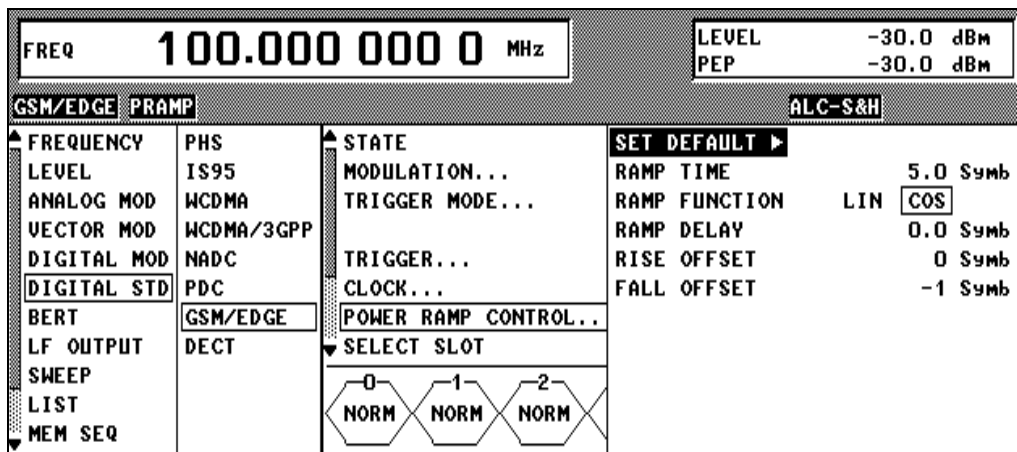

Fig. 2-199 Menu DIGITAL STD - GSM/EDGE - POWER RAMP CONTROL... , SMIQ equipped with Modulation Coder SMIQB20 and Data Generator SMIQB11

(POWER RAMP CONTROL...) **SET DEFAULT** ▶ Resets the subsequent parameters to the factory-set values.

IEC/IEEE-bus : SOUR : GSM : PRAM : PRES

RAMP TIME Input value for the rise and fall time of the envelope at the beginning or end of a slot. The time is set in units of symbol period.

IEC/IEEE-bus SOUR:GSM:PRAM:TIME 2.5

(POWER RAMP CONTROL...)	RAMP FUNCTION	<p>Selection of shape of rising and falling ramp for envelope control.</p> <p>LIN Linear ramp function.</p> <p>COS Cosine function. A more favourable spectrum than that of the LIN function is obtained.</p> <p>IEC/IEEE-bus SOUR:GSM:PRAM:SHAP LIN</p>
	RAMP DELAY	<p>Input value for a shift of the envelope characteristic to the modulated signal. A positive value causes a delay of the envelope. The values are set in the units of the symbol length.</p> <p>IEC/IEEE-bus SOUR:GSM:PRAM:DEL 0.1</p>
	RISE OFFSET	<p>Input value for a positive or negative offset of the rising ramp of the envelope at the beginning of a slot.</p> <p>IEC/IEEE-bus SOUR:GSM:PRAM:ROFF -1</p>
	FALL OFFSET	<p>Input value for a positive or negative offset of the falling ramp of the envelope at the end of a slot.</p> <p>IEC/IEEE-bus SOUR:GSM:PRAM:FOFF 1</p>
SLOT ATTENUATION		<p>Input value in dB for the level reduction of all active slots whose SLOT LEVEL was set to ATTEN. Menu SELECT SLOT allows the slots to be determined whose level is to be reduced.</p> <p>IEC/IEEE-bus command SOUR:GSM:SLOT:ATT 40 DB</p>

SAVE/RCL FRAME... Opens a window for saving and loading a frame configuration. Loading a frame affects all parameters that can be set under SELECT SLOT.

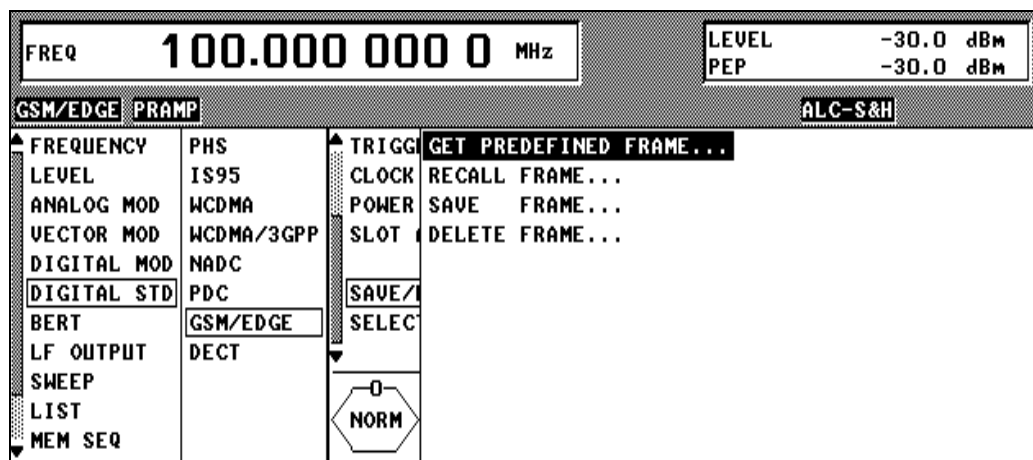

Fig. 2-200 Menu DIGITAL STD - GSM/EDGE - SAVE/RCL FRAME, SMIQ equipped with Modulation Coder SMIQB20 and Data Generator SMIQB11

- (SAVE/RCL FRAME...) **GET PREDEFINED FRAME...** Loads a factory-set frame configuration.
 NB0 Normal Burst in slot 0
 IEC/IEEE-bus : SOUR:GSM:FLIS:PRED:LOAD "nb0"
- RECALL FRAME...** Loads a frame configuration saved by the user.
 IEC/IEEE-bus : SOUR:GSM:FLIS:LOAD "name"
- SAVE FRAME...** Saves a user-defined frame configuration.
 IEC/IEEE-bus : SOUR:GSM:FLIS:STOR "name"
- DELETE FRAME...** Deletes a frame configuration saved by the user.
 IEC/IEEE-bus : SOUR:GSM:FLIS:DEL "name"

SELECT SLOT... Selection of one of 8 possible slots. When selecting the slot, a window is opened in which the data contents belonging to this slot can be defined. If the cursor is placed onto a slot in the diagram, it may be switched on and off by pressing one of the unit keys (toggle function).

Menu selection: BURST TYPE = NORM

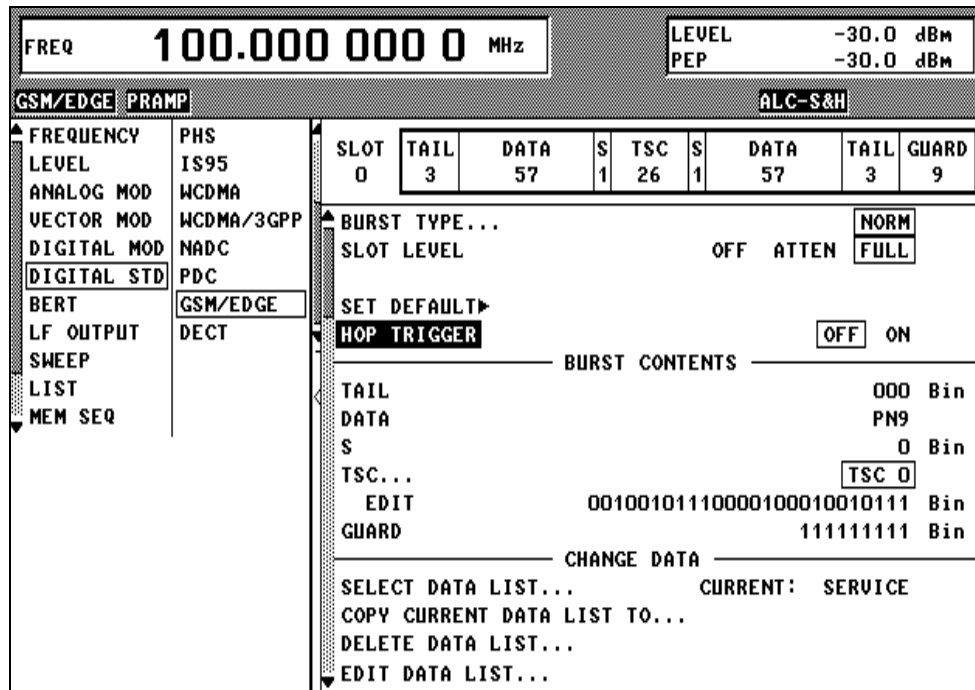

Fig. 2-201 Menu DIGITAL STD - GSM/EDGE - SELECT SLOT - NORM, SMIQ equipped with Modulation Coder SMIQB20 and Data Generator SMIQB11

(SELECT SLOT...)	BURST TYPE	Opens a window for the selection of the burst type used to configure the selected slot. NORM Normal Burst IEC/IEEE : SOUR : GSM : SLOT2 : TYPE NORM
	SLOT LEVEL	Selection of level for selected slot. OFF Maximum attenuation IEC/IEEE : SOUR : GSM : SLOT2 : LEV OFF FULL The level corresponds to the value indicated on the SMIQ LEVEL display. IEC/IEEE : SOUR : GSM : SLOT2 : LEV FULL ATTEN The level is reduced by the value set under SLOT ATTENUATION. IEC/IEEE : SOUR : GSM : SLOT2 : LEV ATT
	SET DEFAULT ►	Resets the subsequent parameters to the factory-set values. IEC/IEEE-bus command : SOUR : GSM : SLOT8 : PRES
	HOP TRIGGER	Switches the HOP trigger signal on or off. With ON selected, a HOP signal will be generated at the end of the selected slot. The signal is available at the HOP output of the PARDATA connector. It can be used to perform a frequency hop mode in the LIST MODE (see section 'List Mode'). IIEEE-bus command SOUR : GSM : SLOT1 : HOPP : TRIG
	TAIL	Display of data contents in the 3 bit data field "Tail". The tail bits are set to 000 according to the GSM standard.
	DATA	Selection of data source for DATA fields. These fields are regarded as a continuous field, i.e. a pseudo-random sequence is fully continued from one DATA field to the next. The following data sources are available: PN.. PRBS data according to CCITT with periods between 2^9-1 and $2^{23}-1$. IEC/IEEE : SOUR : GSM : SLOT3 : DATA PN15 DLIST Data from a programmable data list. IEC/IEEE : SOUR : GSM : SLOT3 : DATA DLIS SERDATA Data from data input SER DATA. IEC/IEEE : SOUR : GSM : SLOT3 : DATA SDAT
	S	Setting for the so-called "Stealing Flag". The selected setting is valid for the two S fields. IEC/IEEE-bus command SOUR : GSM : SLOT2 : SF 1
	TSC...	Opens a window for selecting the so-called "Training Sequence Code". A selection between 8 different training sequences is possible. IEC/IEEE-bus command SOUR : GSM : SLOT2 : TSC 0

<p>(SELECT SLOT...) NORM</p>	<p>EDIT</p> <p>Input field for binary modifications of the training sequence. A modified training sequence is stored as a USER sequence after a SAVE FRAME has been called up.</p> <p>IEC/IEEE-bus command SOUR:GSM:SLOT2:USER #B011011...</p>
<p>GUARD</p>	<p>Display of data content in the "Guard" field in binary form. The length of the field is 8 bit in slots 1,2,3,5,6,7 and 9 bit in slots 0 and 4. It is thus ensured that a frame has exactly 1250 bit as stipulated in the GSM standard.</p>
<p>SELECT DATA LIST...</p>	<p>Opens a window for selecting a stored data list or for generating a new list.</p>
<p>COPY CURRENT DATA LIST TO...</p>	<p>Stores the current data list under a different name.</p>
<p>DELETE DATA LIST...</p>	<p>Deletes a data list.</p>
<p>EDIT DATA LIST...</p>	<p>Opens a window for editing a data list bit-by-bit. The available storage capacity and the length of the current list is displayed in parameters FREE and LEN (see also Section List Editor).</p>
	<p>COPY Copies a list range</p> <p>FILL Fills the range with filler pattern</p> <p>INSERT Inserts a list range at a different position of the list</p> <p>DELETE Deletes a list range</p> <p>EDIT/VIEW Edits or views the list</p>

Menu selection: BURST TYPE = DUMMY

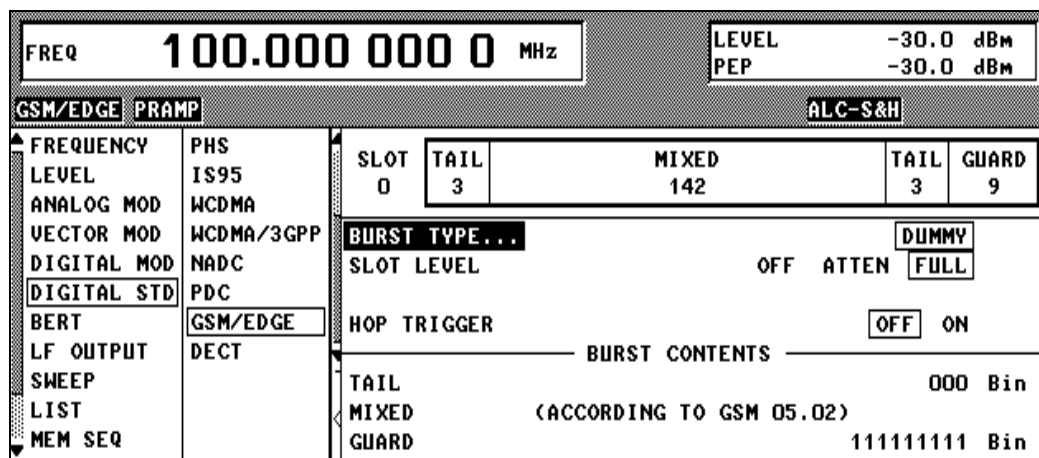

Fig. 2-202 Menu DIGITAL STD - GSM/EDGE - SELECT SLOT - DUMMY, SMIQ equipped with Modulation Coder SMIQB20 and Data Generator SMIQB11

<p>(SELECT SLOT...) DUMMY</p>	<p>BURST TYPE</p>	<p>Opens a window for the selection of the burst type used to configure the selected slot. DUMMY Synchronization Burst IEC/IEEE-bus command SOUR:GSM:SLOT2:TYPE DUMM</p>
	<p>SLOT LEVEL</p>	<p>Selection of level for selected slot. OFF Maximum attenuation IEC/IEEE : SOUR:GSM:SLOT2:LEV OFF FULL The level corresponds to the value indicated on the SMIQ LEVEL display. IEC/IEEE : SOUR:GSM:SLOT2:LEV FULL ATTEN The level is reduced by the value set under SLOT ATTENUATION. IEC/IEEE : SOUR:GSM:SLOT2:LEV ATT</p>
	<p>TAIL</p>	<p>Display of data content in the 3 bit data field "Tail ". The tail bits are set to 000 according to the GSM standard.</p>
	<p>MIXED</p>	<p>Display of data content of the mixed-bit field. It has a data content stipulated by GSM 05.02, the so-called mixed bits": 11111011011101100000101001001110000010010001000000 01111100011100010111000101110001010111010010100011 001100111001111010011111000100101111101010</p>
	<p>GUARD</p>	<p>Display of data content in the Guard field in binary form. The length of the field is 8 bit in slots 1,2,3,5,6,7 and 9 bit in slots 0 and 4. It is thus ensured that a frame has exactly 1250 bit as stipulated in the GSM standard.</p>

Menu selection: BURST TYPE = ALL_DATA

FREQ 100.000 000 0 MHz		LEVEL -30.0 dBm	
		PEP -30.0 dBm	
GSM/EDGE PRAMP		ALC-S&H	
FREQUENCY	PHS	SLOT	DATA
LEVEL	IS95	0	148
ANALOG MOD	WCDMA		
VECTOR MOD	WCDMA/3GPP		
DIGITAL MOD	NADC		
DIGITAL STD	PDC		
BERT	GSM/EDGE		
LF OUTPUT	DECT		
SWEEP			
LIST			
MEM SEQ			
		BURST TYPE... ALL_DATA	
		SLOT LEVEL OFF ATTEN FULL	
		SET DEFAULT▶	
		HOP TRIGGER OFF ON	
		BURST CONTENTS	
		DATA PN9	
		GUARD 11111111 Bin	
		CHANGE DATA	
		SELECT DATA LIST... CURRENT: SERVICE	
		COPY CURRENT DATA LIST TO...	
		DELETE DATA LIST...	
		EDIT DATA LIST...	

Fig. 2-203 Menu DIGITAL STD - GSM/EDGE - SELECT SLOT – ALL_DATA, SMIQ equipped with Modulation Coder SMIQB20 and Data Generator SMIQB11

(SELECT SLOT...) BURST TYPE	Opens a window for the selection of burst type used to configure the selected slot.
ALL_DATA	ALL_DATA Burst type for testing with freely programmable data contents. IEC/IEEE : SOUR:GSM:SLOT2:TYPE ADAT
SLOT LEVEL	Selection of level for selected slot.
OFF	Maximum attenuation IEC/IEEE : SOUR:GSM:SLOT2:LEV OFF
FULL	The level corresponds to the value indicated on the SMIQ LEVEL display. IEC/IEEE : SOUR:GSM:SLOT2:LEV FULL
ATTEN	The level is reduced by the value set under SLOT ATTENUATION. IEC/IEEE : SOUR:GSM:SLOT2:LEV ATT
DATA	Selection of data source for DATA fields. These fields are regarded as a continuous field, i.e. a pseudo-random sequence is fully continued from one DATA field to the next. The following data sources are available:
PN..	PRBS data according to CCITT with periods between 2^9-1 and $2^{23}-1$. IEC/IEEE : SOUR:GSM:SLOT3:DATA PN15
DLIST	Data from a programmable data list. IEC/IEEE : SOUR:GSM:SLOT3:DATA DLIS
SERDATA	Data from data input SER DATA. IEC/IEEE : SOUR:GSM:SLOT3:DATA SDAT
GUARD	Display of data content in the Guard field in binary form. The length of the field is 8 bit in slots 1,2,3,5,6,7 and 9 bit in slots 0 and 4. It is thus ensured that a frame exactly has 1250 bit as stipulated in the GSM standard.

Parameter **SELECT DATA LIST...** to **EDIT DATA LIST...** see menu selection BURST TYPE = NORM

Selection: BURST TYPE = EDGE

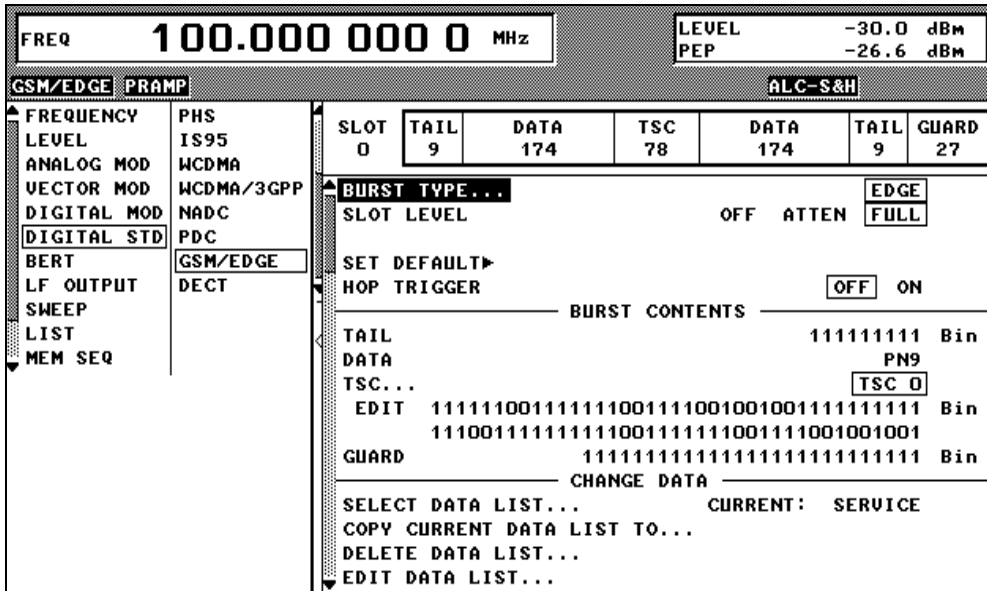

Fig. 2-204 Menu DIGITAL STD - GSM/EDGE - SELECT SLOT – EDGE, SMIQ equipped with Modulation Coder SMIQB20 and Data Generator SMIQB11

- (SELECT SLOT...) BURST TYPE** Opens a window for selecting the burst type to be used for configuring the selected slot.
EDGE EDGE Normal Burst
 IEC/IEEE bus : SOUR : GSM : SLOT2 : TYPE EDGE

- SLOT LEVEL** Selection of the level for the selected slot.
 OFF Maximum attenuation
 IEC/IEEE bus : SOUR : GSM : SLOT2 : LEV OFF
 FULL The level is the same as that indicated in the LEVEL display of SMIQ.
 IEC/IEEE bus : SOUR : GSM : SLOT2 : LEV FULL
 ATTEN The level is reduced by the value set under SLOT ATTENUATION.
 IEC/IEEE bus : SOUR : GSM : SLOT2 : LEV ATT

- SET DEFAULT** ► Resets the following parameters to the factory-selected values.
 IEC/IEEE bus command : SOUR : GSM : SLOT1 : PRES

- HOP TRIGGER** Switches the HOP trigger signal on or off. When set to ON, a HOP signal is generated at the end of the selected slot. The signal is available at the HOP output of the PARADATA connector. It may be used for implementing frequency hopping in the LIST MODE (see section "List Mode").
 IEC/IEEE-bus : SOUR : GSM : SLOT1 : HOPP : TRIG

- TAIL** Display of data contents in the 9-bit data field "Tail". The tail bits are permanently set to 11111111 in line with the GSM standard.

(SELECT SLOT...) EDGE	DATA	<p>Selection of the data source for the DATA fields. These fields are considered as one continuous field, i.e. a pseudo random sequence continues seamlessly from one DATA field to the next. The following data sources can be chosen:</p> <p>PN.. PRBS data according to CCITT with period lengths between 2^9-1 and $2^{23}-1$. IEC/IEEE : SOUR : GSM : SLOT3 : DATA PN15</p> <p>DLIST Data from a programmable data list. IEC/IEEE : SOUR : GSM : SLOT3 : DATA DLIS</p> <p>SERDATA Data via the data input SER DATA. IEC/IEEE : SOUR : GSM : SLOT3 : DATA SDAT</p>
	TSC...	<p>Opens a window for selecting the so-called "training sequence code". One of eight different training sequences can be chosen.</p> <p>IEC/IEEE-bus command : SOUR : GSM : SLOT2 : TSC 0</p> <p>EDIT Field for entering changes to the training sequence in binary form. A modified training sequence is saved as USER sequence after SAVE FRAME was called. IEC/IEEE bus command : SOUR : GSM : SLOT2 : USER #B011011...</p>
	GUARD	<p>Display of data contents in the GUARD field in binary form. The length of the field is 24 bits in slots 1, 2, 3, 5, 6, 7, and 27 bits in slots 0 and 4.</p>
	SELECT DATA LIST...	<p>Opens a window for selecting a stored data list or generating a new list.</p>
	COPY CURRENT DATA LIST TO...	<p>Saves the current data list under a different name.</p>
	DELETE DATA LIST...	<p>Deletes a data list.</p>
	EDIT DATA LIST...	<p>Opens a window for editing a data list bit by bit. The parameters FREE and LEN indicate the free memory capacity and the length of the current list (see also chapter 2, section "List Editor").</p> <p>COPY Copying part of a list FILL Filling a part of the list with a pattern INSERT Inserting a part of the list at a different position within the list DELETE Deleting a part of the list EDIT/VIEW Editing or viewing the list</p>

2.19 Digital Standard DECT

With the options Modulation Coder (SMIQB20) and Data Generator (SMIQB11) provided, modulation signals according to the ETSI DECT standard can be generated. DECT is a TDMA standard for private and public cordless phones.

SMIQ can generate both the transmit signal of a cell station (FP, Fixed Part) and the transmit signal of a personal station (PP, Portable Part). Transmission from FP to PP is called "downlink", "uplink" being used for transmission in the opposite direction.

Uplink and downlink are transmitted in the separate time slots of a frame using the time duplex method. Each frame consists of 24 slots. The data contents of each slot can be defined individually by SMIQ by means of a slot editor. Each slot can be switched on or off. A defined intermediate level can also be set. A maximum of 12 slots within a frame can be switched on simultaneously.

A slot type has to be defined to configure a slot. The following slot types can be selected:

- FULL full slot; simulation of a basic R32 physical channel,
- DOUBLE double slot, simulation of a high capacity R80 physical channel and
- ALL_DATA slot type for test purposes with arbitrarily programmable data contents in full slot format.

The following internal modulation sources are available:

- different PRBS generators with a sequence length between 2^9-1 and $2^{23}-1$ and
- data lists, i.e. freely programmable data sequences from the data generator memory.

For generating DECT signals, SMIQ inserts the modulation data continuously (in real time) into the selected slots. Using a digital signal processor the data generator generates a data sequence with modulation data and control signals for envelope control.

The data generator in SMIQ generates a data stream which is converted into IQ signals in the modulation coder. According to the DECT standard, the default modulation type is GFSK with a symbol rate of 1152 ksymbols/s and Gauss filtering. Symbol rate and filtering can be changed in SMIQ. Alternatively, $\pi/4$ DQPSK with $\sqrt{\cos}$ filtering may be selected.

2.19.1 Sync and Trigger Signals

The data generator generates a data sequence with modulation data, control signals for envelope control, and synchronization signals.

When TRIGGER MODE AUTO is selected, the DECT signal generation starts automatically.

This start can also be activated by an external trigger signal (TRIGGER MODE ARMED_AUTO) which allows a synchronous sequence for BER measurements to be carried out on receivers.

Trigger signals for synchronized sequences can be used for measuring the bit error rate of receivers. A trigger signal can be fed via the TRIGIN input at connector PAR DATA. The active slope of a trigger signal applied there executes a trigger event.

DECT signal generation at a frame limit is started after a trigger event. Data from data lists are inserted into the selected slots starting from the first bit. PRBS generators start with the set initialization status.

Signal generation either starts immediately after the active slope of the trigger signal or after a settable number of symbols (EXT TRIGGER DELAY). Retriggering (RETRIG) can be inhibited for a settable number of symbols (EXT RETRIGGER INHIBIT).

A trigger event can be executed manually or via the IEC/IEEE bus using EXECUTE TRIGGER.

When a trigger event is executed, a trigger signal is output at the TRIGOUT 3 output of SMIQ.

SMIQ also generates the following sync signals:

- a frame clock at TRIGOUT 1 output,
- a frame or multiframe clock at TRIGOUT 2 output with settable position in the frame,
- the symbol clock and the bit clock.

A clock synthesizer on the modulation coder generates the symbol clock and the bit clock in SMIQ. All clock signals are synchronized to the 10-MHz reference of SMIQ. The bit clock is available at connector BIT CLOCK. If desired, the clock synthesizer in SMIQ can be synchronized to an external bit clock.

The clock source is selected in the CLOCK-CLOCK SOURCE EXT menu.

To allow for a trouble-free synchronization of the clock synthesizer first apply the external clock and set the correct symbol rate at SMIQ. Then switch CLOCK SOURCE from INT to EXT.

Note: *The set symbol rate should not differ by more than 1% from the symbol rate of the external signal.*

2.19.2 PN Generators as Internal Data Source

Independent PN generators (Pseudo Noise) can be selected for each slot as data sources for the data fields A-FIELD, B-FIELD and DATA. These PN generators provide pseudo-random bit sequences of different length or period. That is why they are also called PRBS generators (Pseudo Random Binary Sequences).

Data sequences are sequences of maximum length which are generated by means of feedback shift registers.

The following figure gives an example of a 9-bit generator with feedbacks after register 4 and 0 (output).

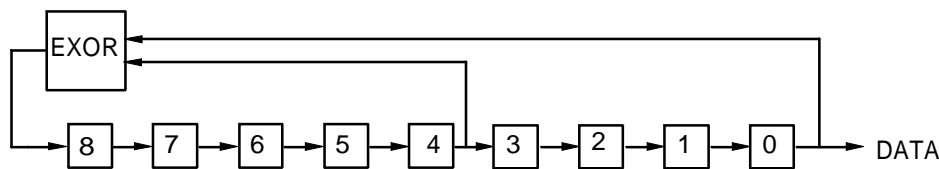

The pseudo-random sequence of a PRBS generator is clearly defined by the number of registers and the feedback. The following table describes all PRBS generators available:

Table 2-32 PRBS generators for DECT

PRBS generator	Length in bits	Feedback after
9 bit	$2^9 - 1 = 511$	Register 4, 0
11 bit	$2^{11} - 1 = 2047$	Register 2, 0
15 bit	$2^{15} - 1 = 32767$	Register 1, 0
16 bit	$2^{16} - 1 = 65535$	Register 5, 3, 2, 0
20 bit	$2^{20} - 1 = 1048575$	Register 3, 0
21 bit	$2^{21} - 1 = 2097151$	Register 2, 0
23 bit	$2^{23} - 1 = 8388607$	Register 5, 0

PN generators PN9,11,15,20 and PN23 are configured according to CCITT Rec. 0.151/152/153. The output sequence is inverted for generators PN15 and PN23.

The start value of the PN generators is different in the slots and equals

$$\text{start value} = 1 + 14 \text{ hex} \times \text{slot number}$$

Example: PN9 generator in slot 1 with start value 15hex = 10101 binary.

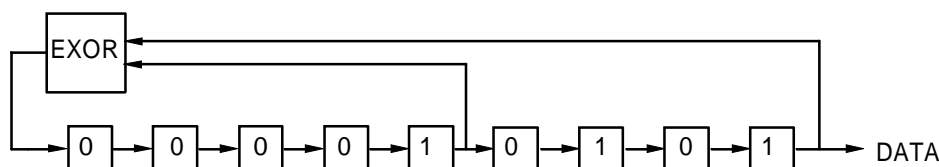

The resulting output sequence is 1010100000010100101011110010 etc.

2.19.3 Lists as Internal Data Source

A freely programmable memory on the data generator serves as an additional internal data source for the data fields of the slots. The data are managed in so-called lists. A list editor allows to select, copy, modify and delete data lists (DATA LIST).

The list editor is available via menu DIGITAL-MOD - SOURCE....

2.19.4 External Modulation Data

External data can (only) be applied via the SERDATA interface. A selection of SERDATA as data source is only possible for a single data field of a slot. For further information on the characteristics of the SERDATA interface see Annex A.

To ensure that the external data bits are assigned to specific positions in the data field of the selected slot and that they are reproducible, the buffer of the RS-232 transmitter and receiver has to be deleted. A triggered start has to follow.

The following setting sequence is required in the DIGITAL STD - DECT menu:

1. Carry out desired settings in menu.
2. Select data source SERDATA for the data field of the slot using SELECT SLOT -
3. Make connection to external data source, but do not yet start external data source.
4. Switch off digital standard using STATE - OFF.
5. Set TRIGGER MODE ARMED_AUTO.
In this state, SMIQ is ready for reception, but discards data that are read in via SERDATA.
6. Switch on digital standard with STATE ON.
7. Start external data source.
The read-in data are written into the receiving buffer. Only if this buffer is filled can SMIQ react to a trigger event.
8. Activate trigger event. Signal generation is thus started at a frame limit. The first bit received via SERDATA is put to the first bit position in the selected data field.

2.19.5 Menu DIGITAL STANDARD - DECT

Menu DIGITAL STD - DECT provides access to settings for generating DECT signals.

Menu selection: DIGITAL STD - DECT

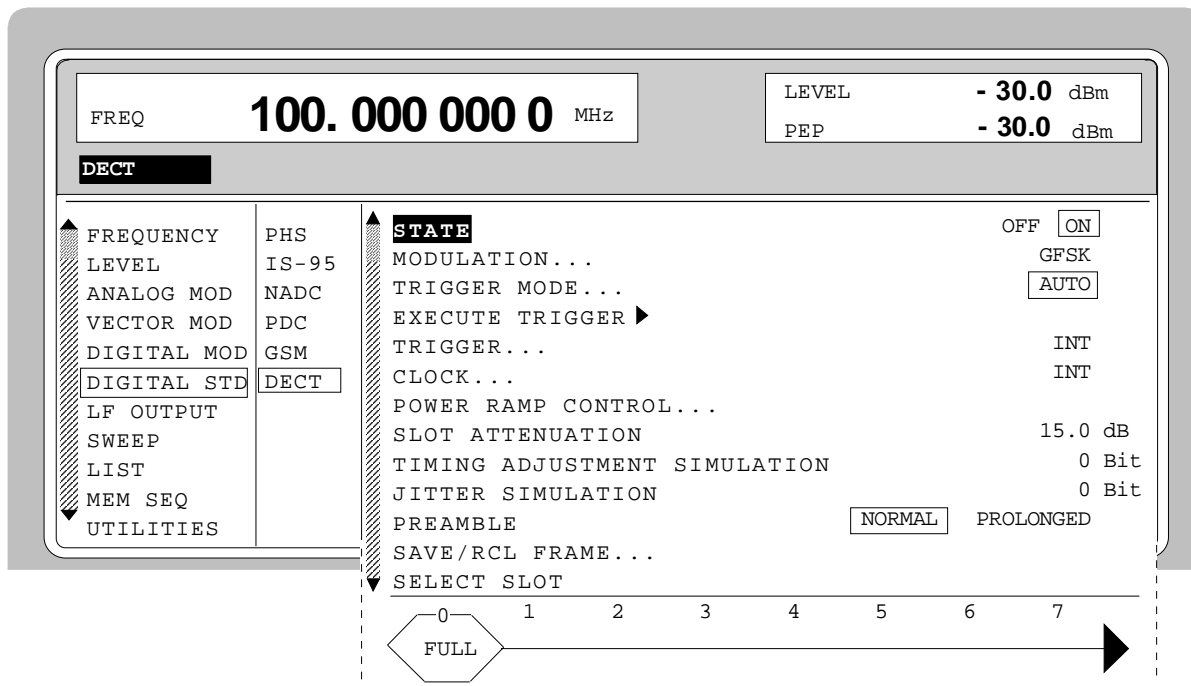

Fig. 2-205 Menu DIGITAL STD - DECT, SMIQ equipped with Modulation Coder SMIQB20 and Data Generator SMIQB11

STATE Switch on/off of Digital Standard DECT modulation. Vector Modulation or Digital Modulation will be switched off automatically.

IEC/IEEE-bus command :SOUR:DECT:STAT ON

MODULATION... Opens a window for setting some of the modulation parameters.

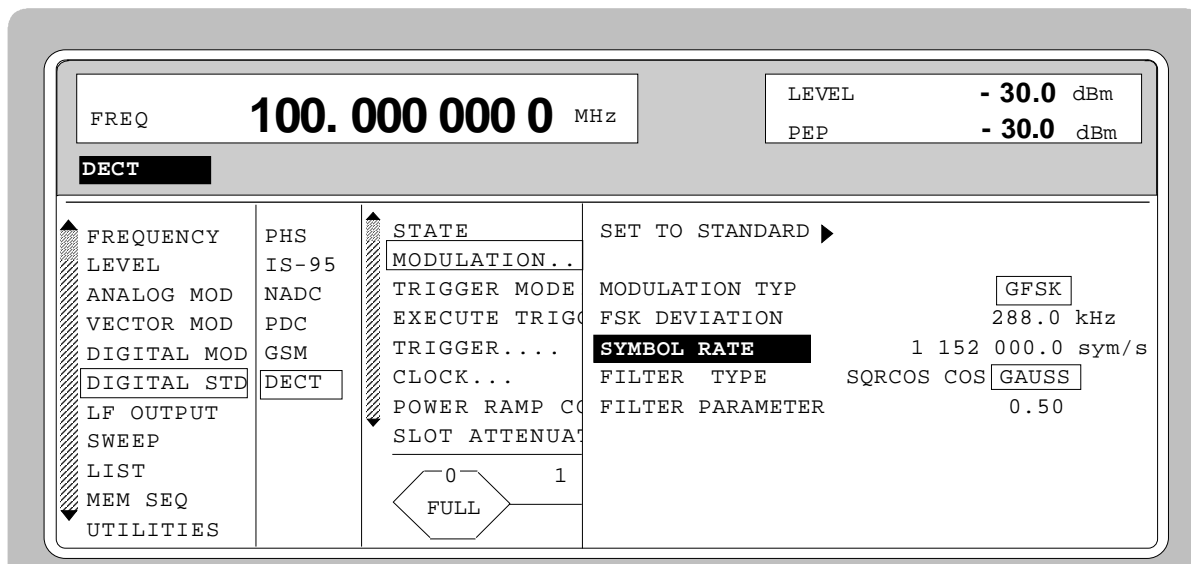

Fig. 2-206 Menu DIGITAL STD - DECT - MODULATION...

(MODULATION...)	SET TO STANDARD ►	Sets the subsequent modulation parameters to the values predefined by the standard. IEC/IEEE-bus :SOUR:DECT:STAN
	MODULATION TYPE	Selection of the modulation type. GFSK is preset. IEC/IEEE-bus :SOUR:DECT:FORM GFSK
	FSK DEVIATION	Input value for the frequency deviation for GFSK modulation IEC/IEEE-bus :SOUR:DECT:FSK 280 KHZ
	SYMBOL RATE	Input value for the symbol rate. 1152 ksymbols/s are preset. IEC/IEEE-bus :SOUR:DECT:SRAT 1151 KHZ
	FILTER TYPE	Selection of baseband filter. For $\pi/4$ DQPSK modulation, a selection between Nyquist filters COS and SQRCOS or a user-defined filter USER (cf. Section Digital Modulation) is possible. IEC/IEEE-bus :SOUR:DECT:FILT:TYPE COS
	FILTER PARAMETER	Input value for the BT value for Gauss filtering or for the roll-off factor for Nyquist filtering. IEC/IEEE-bus SOUR:DECT:FILT:PAR 0.51
TRIGGER MODE...	Opens a window for selecting the trigger mode.	
	AUTO	The DECT signals are continuously transmitted in the activated slots. IEC/IEEE-bus command SOUR:DECT:SEQ AUTO
	RETRIG	The DECT signals are continuously transmitted in the activated slots. A trigger event causes a restart. This mode is not available if values different from zero are set for TIMING ADJUSTMENT or JITTER SIMULATION. IEC/IEEE-bus command :SOUR:DECT:SEQ RETR
	ARMED_AUTO	DECT signal generation does not start until a trigger event has occurred. The unit then automatically switches over to the AUTO mode and can no longer be triggered. IEC/IEEE-bus command :SOUR:DECT:SEQ AAUT
	ARMED_RETRIG	DECT signal generation does not start until a trigger event has occurred. The unit then automatically switches over to the RETRIG mode. Each new trigger event causes a restart. This mode is not available if values different from zero are set for TIMING ADJUSTMENT or JITTER SIMULATION. IEC/IEEE-bus command :SOUR:DECT:SEQ ARET

EXECUTE TRIGGER ►

Executes a trigger even to start the DECT signal generation. This menu item is not available if TRIGGER MODE - AUTO is set.

IEC/IEEE-bus command :TRIG:DM:IMM

TRIGGER...

Opens a window for selecting the trigger source, for configuring the trigger output signals and for setting the time delay of an external trigger signal.

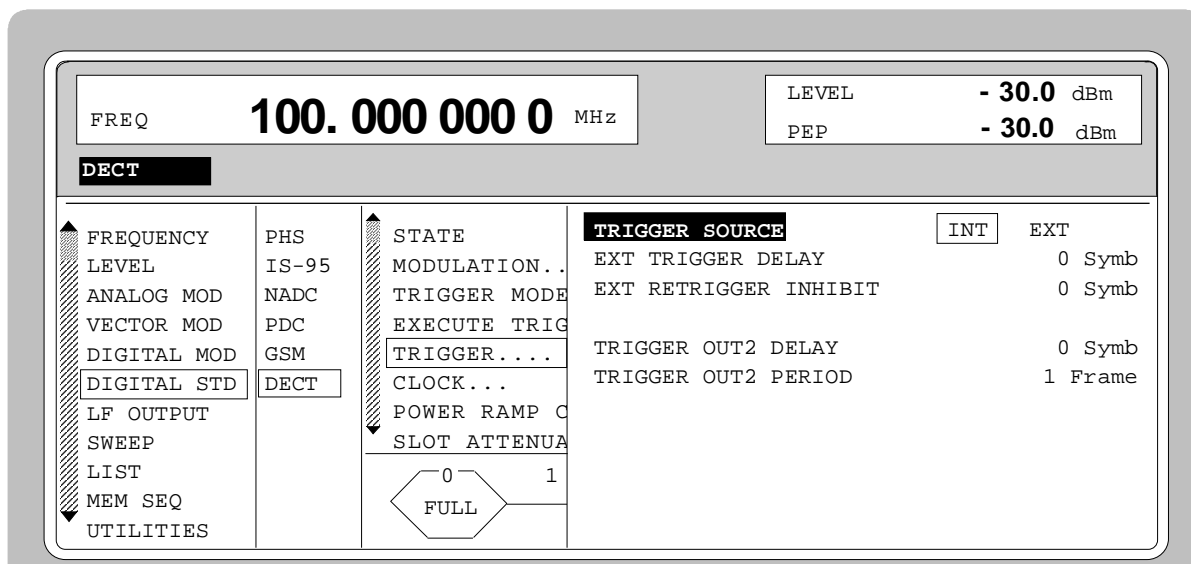

Fig. 2-207 Menu DIGITAL STD - DECT_TRIGGER..., SMIQ equipped with Modulation Coder SMIQB20 and Data Generator SMIQB11

(TRIGGER...)

TRIGGER SOURCE

Selection of trigger source.

EXT The DECT signal generation is started by the active slope of an external trigger signal.

The polarity, the trigger threshold and the input resistance of the TRIGIN input can be modified in menu DIGITAL MOD - EXT INPUTS.

INT A trigger event can be executed by EXECUTE TRIGGER ►.

IEC/IEEE-bus :SOUR:DECT:TRIG:SOUR EXT

(TRIGGER...)	EXT TRIGGER DELAY	<p>Setting the number of symbols by which an external trigger signal is delayed before it starts the DECT signal generation. This is used for setting the time synchronization between the SMIQ and the DUT.</p> <p>IEC/IEEE-bus :SOUR:DECT:TRIG:DEL 3</p>
	EXT RETRIGGER INHIBIT	<p>Setting the number of symbols for which a restart is inhibited after a trigger event. With TRIGGER MODE RETRIG selected, each new trigger signal restarts the DECT signal generation. This restart can be inhibited for the entered number of symbols.</p> <p>Example: The entry of 1000 symbols causes new trigger signals to be ignored for the duration of 1000 symbols after a trigger event</p> <p>IEC/IEEE-bus :SOUR:DECT:TRIG:INH 1000</p>
	TRIGGER OUT2 DELAY	<p>Input value of delay of trigger signal at TRIGOUT 2 output compared with beginning of frame.</p> <p>IEC/IEEE-bus :SOUR:DECT:TRIG:OUTP:DEL 2</p>
	TRIGGER OUT2 PERIOD	<p>Input value of output signal period at TRIGOUT 2 output given in frames.</p> <p>IEC/IEEE-bus :SOUR:DECT:TRIG:OUTP:PER 1</p>

CLOCK... Opens a window for selecting the clock source and for setting a delay.

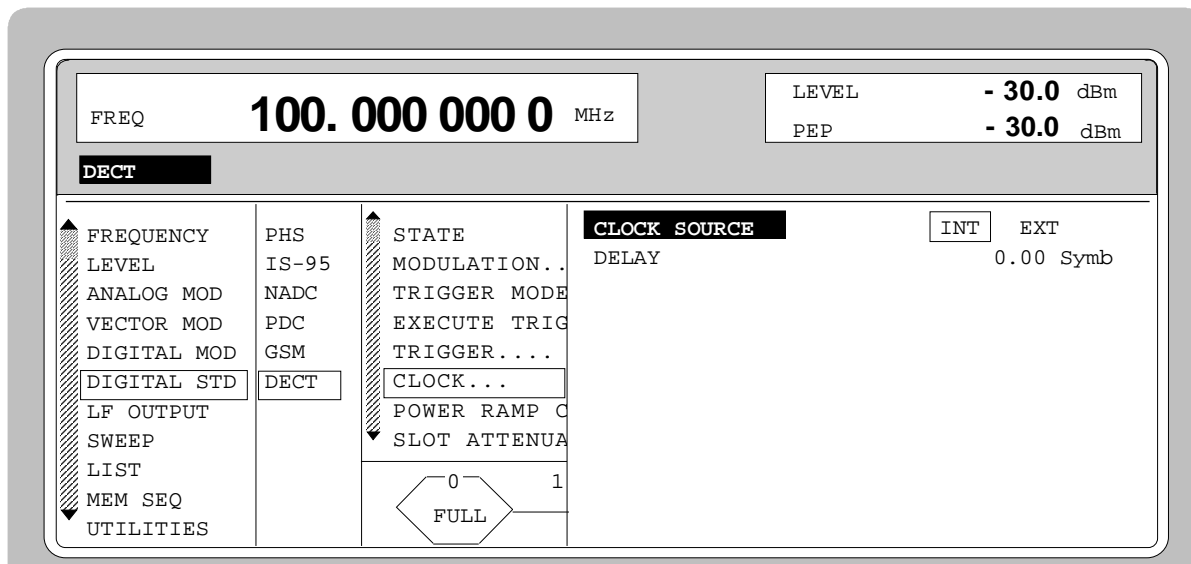

Fig. 2-208 Menu DIGITAL STD - DECT - CLOCK..., SMIQ equipped with Modulation Coder SMIQB20 and Data Generator SMIQB11

(CLOCK...) **CLOCK SOURCE** Selection of clock source.

INT SMIQ uses internally generated clock signals.

EXT An external symbol clock or bit clock is fed in at connectors SYMBOL CLOCK or BIT CLOCK. The clock synthesizer on the modulation coder is synchronized to this clock.

 The symbol rate has to be set with an accuracy of $\pm 1\%$.

 The polarity, the trigger threshold and the input resistance of the clock inputs can be modified in menu DIGITAL MOD - EXT INPUTS.

IEC/IEEE-bus command :SOUR:DECT:CLOC:SOUR INT

DELAY Setting the delay of generated modulation signal to an external clock.

 This can be used, for example, for synchronization with a second unit to achieve time synchronization between the modulation signals of the two units.

IEC/IEEE-bus command :SOUR:DECT:CLOC:DEL 0.5

POWER RAMP CONTROL...

Opens a window for setting the envelope control, especially for the rising and falling ramp at the beginning and end of a slot.

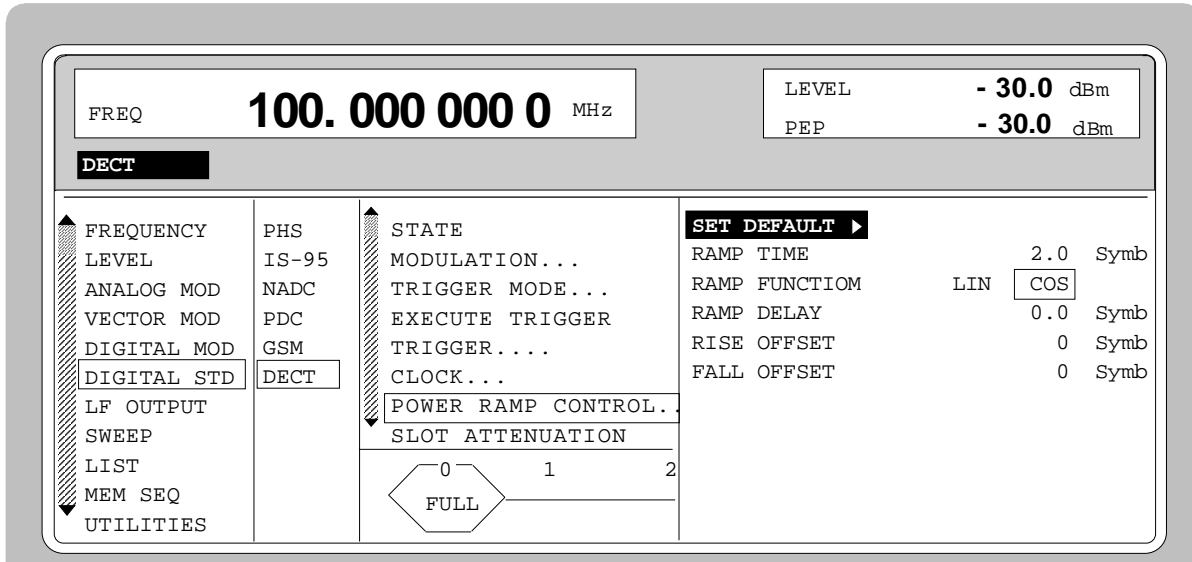

Fig. 2-209 Menu DIGITAL STD - DECT - POWER RAMP CONTROL... , SMIQ equipped with Modulation Coder SMIQB20 and Data Generator SMIQB11

(POWER RAMP CONTROL...)	SET DEFAULT	<p>Sets the subsequent parameters to factory-set default values.</p> <p>IEC/IEEE-bus SOUR:DECT:PRAM:PRES</p>
	RAMP TIME	<p>Input value for the rise and fall time of the envelope at the beginning or end of a slot. The time is set in units of the symbol period.</p> <p>IEC/IEEE-bus SOUR:DECT:PRAM:TIME 1.5</p>
	RAMP FUNCTION	<p>Selection of shape of rising and falling ramp for envelope control.</p> <p>LIN Linear ramp function.</p> <p>COS Cosine function. A more favorable spectrum than that of the LIN function is obtained.</p> <p>IEC/IEEE-bus SOUR:DECT:PRAM:SHAP LIN</p>
	RAMP DELAY	<p>Input value for a shift of the envelope characteristic to the modulated signal. A positive value causes a delay of the envelope. The values are set in units of the symbol length.</p> <p>IEC/IEEE-bus SOUR:DECT:PRAM:DEL 0.1</p>
	RISE OFFSET	<p>Input value for a positive or negative offset of the rising ramp of the envelope at the beginning of a slot.</p> <p>IEC/IEEE-bus SOUR:DECT:PRAM:ROFF -1</p>
	FALL OFFSET	<p>Input value for a positive or negative offset of the falling ramp of the envelope at the end of a slot.</p> <p>IEC/IEEE-bus : SOUR:DECT:PRAM:FOFF 1</p>

SLOT ATTENUATION Input value for the level attenuation in dB of all active slots whose SLOT LEVEL was set to ATTEN. The slots whose level is to be attenuated are defined in the menu SELECT SLOT.

IEC/IEEE-bus command : SOUR:DECT:SLOT:ATT 40 DB

TIMING ADJUSTMENT SIMULATION

Input value for the number of bits used for simulating "Timing Adjust" in DECT instruments. Each 35th frame is extended (positive input values) or shortened (negative values) by the number of bits set.

IEC/IEEE-bus command : SOUR:DECT:SIM:TADJ -1

JITTER SIMULATION

Input value for the number of bits used for jitter simulation. A jitter is simulated by advancing the selected number of bits for even-numbered frames in time whereas ordinary timing is generated for odd-numbered frames.

IEC/IEEE-bus command : SOUR:DECT:SIM:JITT 1

PREAMBLE

Selection of the preamble type for full and double slot.

NORMAL The preamble field has a length of 16 bits.

PROLONGED The preamble field has a length of 32 bits.

IEC/IEEE-bus command : SOUR:DECT:PRE NORM

SAVE/RCL FRAME...

Opens a window for saving and loading a frame configuration. Loading a frame affects all parameters that can be set under SELECT SLOT.

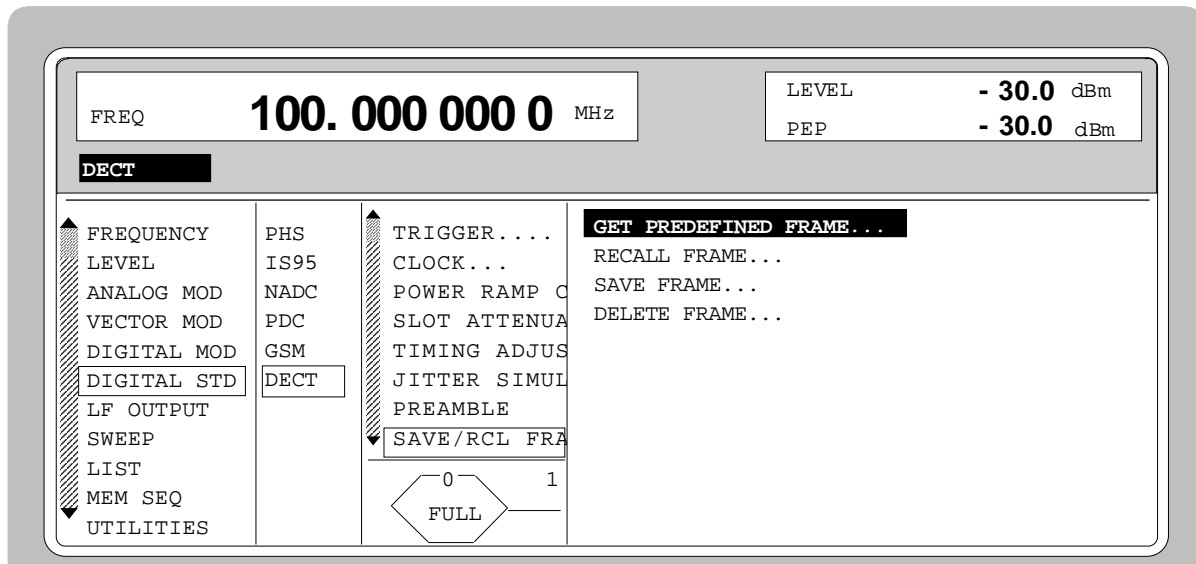

Fig. 2-210 Menu DIGITAL STD - DECT - SAVE/RCL FRAME, SMIQ equipped with Modulation Coder SMIQB20 and Data Generator SMIQB11

(SAVE/RCL FRAME...)	GET PREDEFINED FRAME...	Loads a factory-set frame configuration.
		DNFULL All downlink slots numbered 0 to 11 are active as full slots.
		UPFULL All uplink slots numbered 12 to 23 are active as full slots.
		FULL_0 Only slot no. 0 is active as a full slot.
		DOUB_0 Slots no. 0 and 1 are active as double slots.
		IEEE SOUR:DECT:FLIS:PRED:LOAD "name"
	RECALL FRAME...	Loads a frame configuration saved by the user.
		IEC/IEEE-bus SOUR:DECT:FLIS:LOAD "name"
	SAVE FRAME...	Saves a user-defined frame configuration.
		IEC/IEEE-bus SOUR:DECT:FLIS:STOR "name"
	DELETE FRAME...	Deletes a frame configuration saved by the user.
		IEC/IEEE-bus SOUR:DECT:FLIS:DEL "name"

SELECT SLOT...

Selection of one of 24 possible slots. When selecting the slot, a window is opened in which the data contents belonging to this slot can be defined. 12 slots are available for uplink and downlink, respectively. They are labeled UP<i> and DN<i> in the display where i varies from 0 to 23. Up to 12 of the 24 slots can be active at the same time. If the cursor is placed onto a slot in the diagram, the SLOT LEVEL may be modified by pressing one of the unit keys (toggle function).

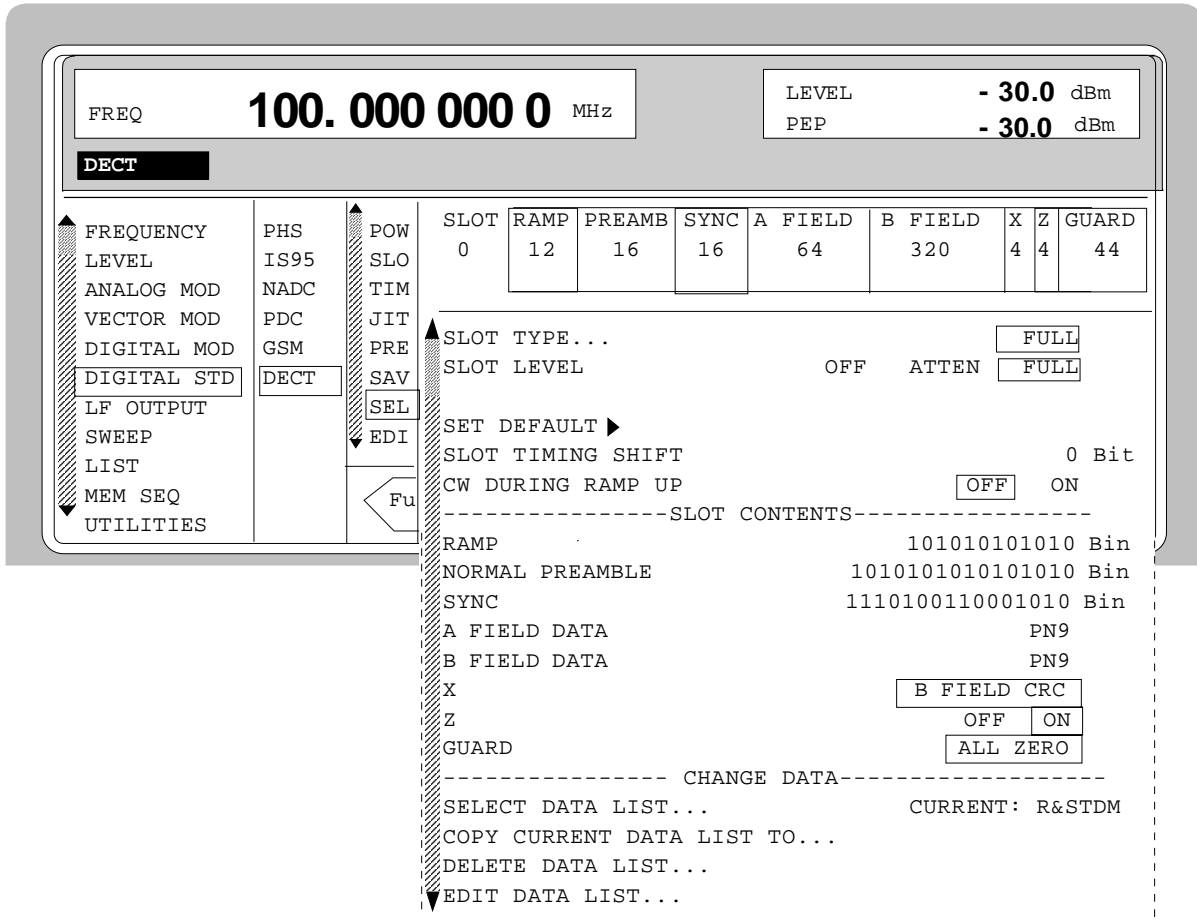

Fig. 2-211 Menu DIGITAL STD - DECT - SELECT SLOT, SMIQ equipped with Modulation Coder SMIQB20 and Data Generator SMIQB11

(SELECT SLOT)	SLOT TYPE...	<p>Opens a window for selecting the slot type.</p> <p>FULL Full slot configuration for simulating a basic R32 physical channel.</p> <p>IEEE-bus : SOUR:DECT:SLOT2:TYPE FULL</p> <p>DOUBLE Double slot configuration for simulating a high capacity R80 physical channel.</p> <p>IEEE-bus : SOUR:DECT:SLOT2:TYPE DOUB</p> <p>ALL_DATA SLOT type for test purposes with arbitrarily programmable data contents.</p> <p>IEEE-bus : SOUR:DECT:SLOT2:TYPE ADAT</p>
----------------------	---------------------	--

(SELECT SLOT)	SLOT LEVEL	<p>Selection of the level for the selected slot.</p> <p>OFF Maximum attenuation IEEE bus : SOUR:DECT:SLOT2:LEV OFF</p> <p>FULL The level corresponds to the value indicated on the SMIQ LEVEL display. IEEE bus : SOUR:DECT:SLOT2:LEV FULL</p> <p>ATTEN The level is attenuated by the value set under SLOT ATTENUATION. IEEE bus : SOUR:DECT:SLOT2:LEV ATT</p> <p>Note: <i>If the cursor is placed onto a slot in the diagram, the SLOT LEVEL may be modified by pressing one of the unit keys (toggle function).</i></p>
	SET DEFAULT ►	<p>Resets the subsequent parameters to factory-set default values. IEC/IEEE-bus command SOUR:DECT:SLOT8:PRES</p>
	SLOT TIMING SHIFT	<p>Input value for the number of bits used for simulating a faulty slot timing. The active slot is shifted in time by the selected number of bits. A positive input value delays the slot, a negative value advances the slot in time. IEEE bus command :SOUR:DECT:SLOT2:STSH 1</p>
	CW DURING RAMP UP	<p>Switches the modulation during the rise of the power ramp on or off.</p> <p>ON Before the preamble starts, the modulation is switched off so that only the unmodulated carrier is generated.</p> <p>OFF Before the preamble starts, the modulation is switched on and the data bits in the ramp field are modulated. IEEE bus command :SOUR:DECT:SLOT2:RAMP:CW ON</p>
	RAMP	<p>Input value for the 12-bit data field RAMP in binary format. This data field is not defined in the DECT standard. It is used to define the data contents during the rise of the power ramp. A series of data representing the natural extension of the preamble bits in forward direction is set by default. IEEE :SOUR:DECT:SLOT2:RAMP:DATA #B111111111111</p>
	NORMAL PREAMBLE	<p>Input value for the NORMAL PREAMBLE in binary format. According to the DECT standard, the default setting for this 16-bit data field is different for uplink and downlink slots. This data field is not available for slot type ALL_DATA. IEEE :SOUR:DECT:SLOT2:PRE:DATA #B1010...</p>

(SELECT SLOT)	PROLONGED PREAMBLE	<p>Input value for the PROLONGED PREAMBLE in binary format. According to the DECT standard, the default setting for this 32-bit data field is different for uplink and downlink slots. This data field is not available for slot type ALL_DATA.</p> <p>IEEE : SOUR:DECT:SLOT2:PRE:PROL:DATA #B1010...</p>
	SYNC	<p>Input value for the 16-bit data field SYNC in binary format. According to the DECT standard, the default setting for this 32-bit data field is different for uplink and downlink slots. This data field is not available for slot type ALL_DATA.</p> <p>IEEE : SOUR:DECT:SLOT2:SYNC #B1001...</p>
	A FIELD DATA	<p>Selection of the data source for the A FIELD. The 64-bit A data field is only displayed for the slot types FULL and DOUBLE.</p> <p>PN.. PRBS data according to CCITT V52 or Rec. 0.151 with period lengths between 2^9-1 and $2^{23}-1$.</p> <p>IEEE bus : SOUR:DECT:SLOT3:AFI PN15</p> <p>DLIST Data from a programmable list.</p> <p>IEEE bus : SOUR:DECT:SLOT3:AFI DLIS "name" : SOUR:DECT:SLOT3:AFI DLIS</p> <p>SERDATA Data fed in via the entry SER DATA.</p> <p>IEEE-bus : SOUR:DECT:SLOT3:AFI SDAT</p>
	B FIELD DATA	<p>Selection of the data source for the B FIELD. The B data field is only displayed for the slot types FULL and DOUBLE. Its length is 320 bits for full slot and 800 bits for double slot.</p> <p>PN.. PRBS data according to CCITT V52 or Rec. 0.151 with period lengths between 2^9-1 and $2^{23}-1$.</p> <p>IEE-bus : SOUR:DECT:SLOT3:BFI PN15</p> <p>DLIST Data from a programmable list.</p> <p>IEEE-bus : SOUR:DECT:SLOT3:BFI DLIS "name" : SOUR:DECT:SLOT3:BFI DLIS</p> <p>SERDATA Data fed in via the entry SER DATA.</p> <p>IEEE-bus : SOUR:DECT:SLOT3:BFI SDAT</p>

(SELECT SLOT)	DATA	<p>Selection of the data source for the 424-bit data field DATA. The B data field is only displayed for the slot type ALL_DATA.</p> <p>PN.. PRBS data according to CCITT V52 or Rec. 0.151 with period lengths between 2^9-1 and $2^{23}-1$.</p> <p>IEEE-bus : SOUR:DECT:SLOT3:DATA PN15</p> <p>DLIST Data from a programmable list.</p> <p>IEEE-bus : SOUR:DECT:SLOT3:DATA DLIS "name" : SOUR:DECT:SLOT3:DATA DLIS</p> <p>SERDATA Data fed in via the entry SER DATA.</p> <p>IEEE-bus : SOUR:DECT:SLOT3:DATA SDAT</p>
X		<p>This 4-bit data field can not be edited. It contains a CRC (Cyclic Redundancy Code) generated from the data in the B data field according to the DECT standard. This data field is not available for slot type ALL_DATA.</p>
Z		<p>Switches the Z field on and off. This function is available for the slot types FULL and DOUBLE.</p> <p>ON The CRC (Cyclic Redundancy Code) generated for the X field is repeated in the 4-bit data field Z.</p> <p>OFF The Z field is not activated. The guard field is extended by 4 bits.</p> <p>IEEE-bus command :SOUR:DECT:SLOT2:ZFI ON</p>
	GUARD	<p>This data field can not be edited and contains zero data. At the beginning of the GUARD field, the power ramp of the active slot starts falling.</p>
	SELECT DATA LIST...	<p>Opens a window for selecting a stored data list or for generating a new list.</p>
	COPY CURRENT DATA LIST TO...	<p>Stores the current data list under a different name.</p>
	DELETE DATA LIST...	<p>Deletes a data list.</p>
	EDIT DATA LIST...	<p>Opens a window for editing a data list bit-by-bit. The available storage capacity and the length of the current list is displayed in parameters FREE and LEN (see also Section List Editor).</p> <p>COPY Copies a list range</p> <p>FILL Fills the range with filler pattern</p> <p>INSERT Inserts a list range at a different position of the list</p> <p>DELETE Deletes a list range</p> <p>EDIT/VIEW Edits or views the list</p>

2.20 Digital Standard GPS

When equipped with the options Modulation Coder (SMIQB20), Data Generator (SMIQB11) and Digital Standard GPS (SMIQB51), SMIQ can generate the signal of a GPS satellite. Section 2.20.1 provides an introductory overview of the Global Positioning System (GPS). Section 2.20.2 then describes the associated control functions. For more detailed information on generating GPS signals, refer to section 2.20.3.

2.20.1 Description of Global Positioning System (GPS)

The Global Positioning System consists of several satellites circling the earth in low orbits. The position of a receiver on the earth can be determined by carrying out delay measurements of at least four signals emitted by different satellites.

Being transmitted on a single carrier frequency, the signals of the individual satellites can be distinguished by means of correlation (Gold) codes (with GPS, these codes are known as C/A codes). Information on time and satellite orbit is contained in the navigation data emitted by each satellite. In this case, the C/A codes are used as spreading codes (see CDMA) for the navigation data.

Each GPS satellite emits an individual navigation data sequence spread by the C/A code assigned to it at the carrier frequency $L1 = 1.57542$ GHz. A GPS signal of this type (see Table 2-33 GPS system parameters), which allows basic receiver function tests to be carried out, can be generated by SMIQ for one satellite.

Table 2-33 GPS system parameters

Carrier frequency	1.57542 GHz
Signal level, after antenna	Approx. -125 dBm to [1] and [2], depending on receive conditions
Doppler shift	-10 kHz to +10 kHz settable
Symbol rate (C/A code)	1.023 Msps
C/A codes	1 to 37 settable, 1023 chips per C/A code
Modulation	BPSK
Information data rate (navigation data)	50 Hz
Frame structure of navigation data	25 frames consisting of 5 subframes where 1 subframe consists of 10 words, 1 word consists of 30 data bits, 1 data bit consists of 20460 C/A code chips.

Use of navigation data

The C/A code used is fundamental to the simulation of GPS signals. The C/A code can be set from 1 to 37 in the operating menu and specifies the satellite to be simulated.

In addition to this, navigation data play an extremely important role, since they are essential for calculating the positions of the four satellites, which are the minimum prerequisite for localization purposes. However, even if only one satellite is available (as simulated by SMIQ), pseudo navigation data can be used to check the decoding of navigation information (such as GPS time, almanac and ephemeris) in addition to the recognition of the C/A code.

Current almanac data can be downloaded via the Internet. Once converted into navigation data via PC application software available on the Rohde & Schwarz homepage (www.rohde-schwarz.com, Application Note 1GP46, AlmanacUploader), the data can be transferred to SMIQ as a data list. This ensures that any navigation data records can be used for GPS signal generation in SMIQ.

For more detailed information on the content and frame structure of navigation data, as well as C/A code generation, refer to the following documentation.

References:

- [1] Interface Control Document ICD-GPS-200.
 [2] Global Positioning System Standard Positioning Service Signal Specification, 2nd Edition, 1995.

2.20.2 GPS Menu

The following graphics show the menu for generating a GPS signal for one satellite. The individual menu items are explained below:

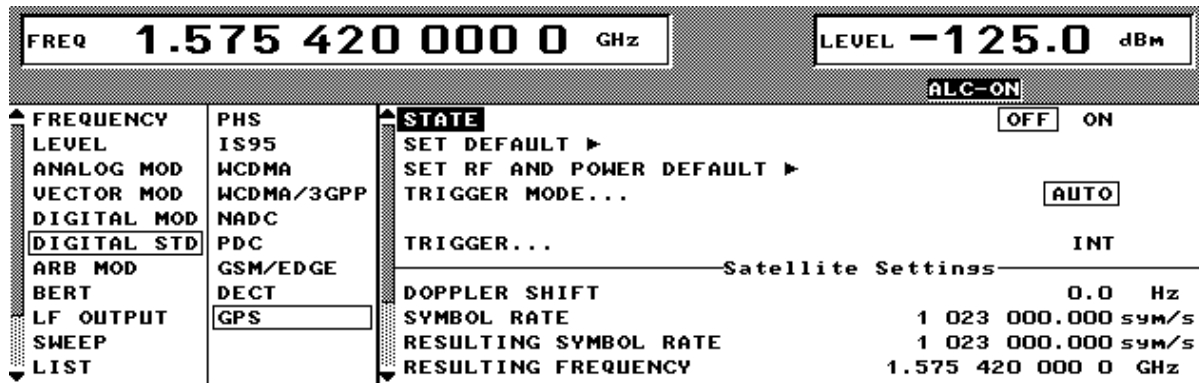

Fig. 2-212 DIGITAL STD - GPS menu

STATE

Switch-on/off of modulation - digital standard GPS. If vector modulation, digital modulation or another digital standard were switched on, they are automatically switched off.

STATE = ON starts the calculation and output of the GPS signal on the basis of the current settings. There are no significant delays until the signal is output, since the signal is generated in realtime.

IEC/IEEE-bus command : SOUR : GPS : STAT ON

Note: When a parameter is changed (exception: DOPPLER SHIFT and SYMBOL RATE), STATE is automatically switched to OFF to ensure that the set values and the output signal are consistent. Once all the values have been changed, STATE can manually be set to ON again. This can be done using the menu parameter STATE or the MOD ON/OFF key below the rollkey.

SET DEFAULT ▶

Sets the default setting for GPS:

- The DOPPLER SHIFT is set to 0 kHz.
- The set SYMBOL RATE is positioned to 1.023 Msps.
- The C/A CODE 1 is used.
- PATTERN is used as NAVIGATION DATA SOURCE.
- The PATTERN is set to 10101010101010.
- All TRIGGER settings are set to default values.

IEC/IEEE-bus command : SOUR : GPS : PRES : STAN

SET RF AND POWER DEFAULT ►	<p>Sets the RF default setting for GPS:</p> <ul style="list-style-type: none"> • The frequency FREQ is set to the GPS carrier frequency L1 of 1.57542 GHz. • The output level LEVEL is set to -125.0 dBm. <p>IEC/IEEE-bus command : <code>SOUR:GPS:PRES:RF</code></p>
TRIGGER MODE	<p>Configuration of autorun control of generated GPS signal.</p> <p>AUTO The GPS signal calculated in realtime is immediately output and cyclically repeated. Trigger events are ignored. IEC/IEEE-bus command : <code>SOUR:GPS:SEQ AUTO</code></p> <p>RETRIG The GPS signal calculated in realtime is immediately output and cyclically repeated. A trigger event causes a restart from the first navigation data bit. IEC/IEEE-bus command : <code>SOUR:GPS:SEQ RETR</code></p> <p>ARMED_AUTO Only a trigger event causes a start of the GPS signal from the first navigation data bit. Further trigger events are ignored. IEC/IEEE-bus command : <code>SOUR:GPS:SEQ AAUT</code></p> <p>ARMED_RETRIG Only a trigger event causes a start of the GPS signal from the first navigation data bit. Any other trigger event causes a restart. IEC/IEEE-bus command : <code>SOUR:GPS:SEQ ARET</code></p>
EXECUTE TRIGGER ►	<p>Executes a trigger event to start the GPS signal. IEC/IEEE-bus command : <code>TRIG:DM:IMM</code></p>
TRIGGER...	<p>Opens a window for selecting the trigger source, configuring trigger output signals, and setting the delay of an external trigger signal.</p> <p>TRIGGER SOURCE Selects the trigger source.</p> <p style="padding-left: 40px;">EXT The GPS signal is started from the first navigation bit with the active edge of an external trigger signal. The polarity, trigger threshold, and input impedance of the TRIGIN input can be changed in the DIGITAL MOD - EXT INPUTS menu.</p> <p style="padding-left: 40px;">INT A trigger event is manually started by EXECUTE TRIGGER. IEC/IEEE-bus command : <code>SOUR:GPS:TRIG:SOUR EXT</code></p> <p>EXT TRIGGER DELAY Sets the number of chips by which an external trigger signal is delayed before it starts the GPS signal. This is used to set up synchronization with the DUT or other units. IEC/IEEE-bus command : <code>SOUR:GPS:TRIG:DEL 3</code></p>

TRIGGER...	EXT RETRIGGER INHIBIT	<p>Sets the number of chips by which a restart is delayed after a trigger event. If the TRIGGER MODE RETRIG was selected, every further trigger signal restarts the GPS signal. This restart can be inhibited for the number of chips that have been entered.</p> <p>Example: Entry of 20460 chips (corresponds to a navigation data bit) causes every further trigger signal to be ignored for the duration of 20460 chips after the last trigger event.</p> <p>IEC/IEEE-bus command : SOUR:GPS:TRIG:INH 20460</p>
	TRIGGER OUT 1/2	<p>Selects the signals for outputs TRIGOUT 1 and TRIGOUT 2 of the PARADATA connector.</p> <p>C/A_CODE Marker signal for every C/A-code sequence (1023 chips). IEC/IEEE-bus command: :SOUR:GPS:TRIG:OUTP1 CODE</p> <p>NAVBIT Marker signal for every navigation data bit (20460 chips). IEC/IEEE-bus command: :SOUR:GPS:TRIG:OUTP1 NBIT</p> <p>NAVWORD Marker signal for every navigation data word (30 bits). IEC/IEEE-bus command: :SOUR:GPS:TRIG:OUTP1 NWOR</p> <p>SUBFRAME Marker signal for every navigation subframe (corresponds to 10 words). IEC/IEEE-bus command: :SOUR:GPS:TRIG:OUTP1 SFR</p> <p>FRAME Marker signal for every navigation frame (corresponds to 5 subframes). IEC/IEEE-bus command: :SOUR:GPS:TRIG:OUTP1 FRAM</p>
	TRIGGER OUT 1/2 POL	<p>Selects the polarity of the signals at the TRIGOUT 1 and TRIGOUT 2 outputs of the PARADATA connector.</p> <p>IEC/IEEE-bus command : SOUR:GPS:OUTP2:POL POS</p>
	TRIGGER OUT 1/2 DELAY	<p>Enters the number of chips by which the selected trigger output signal is delayed.</p> <p>IEC/IEEE-bus command : SOUR:GPS:OUTP2:DEL 0</p>

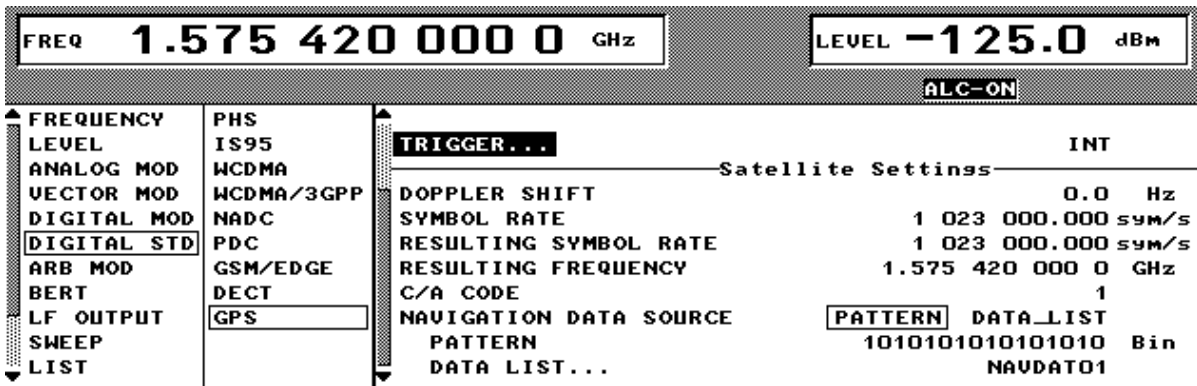

Fig. 2-213 DIGITAL STD - GPS menu

DOPPLER SHIFT Sets the desired Doppler shift of the GPS signal. This affects the symbol rate used as well as the frequency shift of the carrier signal.
IEC/IEEE-bus command : SOUR:GPS:DSH 0

SYMBOL RATE Sets the basic value of the symbol rate for zero Doppler, i.e. without Doppler shift. This value is used to calculate the actual symbol rate as a function of the Doppler shift set. At a Doppler shift of 0 Hz, the values of SYMBOL RATE and RESULTING SYMBOL RATE (see below) are identical.
IEC/IEEE-bus command : SOUR:GPS:SRAT 1023000.0

RESULTING SYMBOL RATE Displays the physical symbol rate currently used. The value is obtained from the set frequency, the Doppler shift and the set basic symbol rate for zero Doppler according to the following equation:

$$f_{Symbol_{resulting}} = f_{Symbol_{ZeroDoppler}} * \left(1 + \frac{f_{Doppler}}{FREQ} \right)$$

IEC/IEEE-bus command : SOUR:GPS:CURR:SRAT?

RESULTING FREQUENCY Displays the physical carrier frequency currently output. The value is obtained from the sum of the set frequency under FREQ and Doppler shift according to the following equation:

$$f = FREQ + f_{Doppler}$$

IEC/IEEE-bus command : SOUR:GPS:CURR:FREQ?

C/A CODE Sets the C/A code for spreading the navigation data. This clearly defines the simulated GPS satellite.
IEC/IEEE-bus command : SOUR:GPS:CODE 1

NAVIGATION DATA SOURCE Selects the navigation data source. Either simple bit patterns (see PATTERN) or more complex data lists (see DATA LIST) with GPS-specific navigation data (ephemeris and almanac), for example, can be selected.
IEC/IEEE-bus command : SOUR:GPS:DATA PATT

PATTERN	Sets the bit pattern to be used as navigation data source provided that PATTERN has been selected as NAVIGATION DATA SOURCE. IEC/IEEE-bus command : SOUR:GPS:DATA:PATT #H1234,16
DATA LIST	Selects the data list to be used as navigation data source provided that DATA_LIST has been selected as NAVIGATION DATA SOURCE . IEC/IEEE-bus command : SOUR:GPS:DATA:DLIS "name"

2.20.3 Instructions for Generating GPS Signals

This section provides background information for generating GPS signals and is intended to facilitate generating signals with specific characteristics as well as user prompting.

1. Generating a simple GPS signal

After the default values have been set, a cyclically repetitive GPS signal is generated for one satellite by switching STATE to ON. Changing the C/A CODE setting enables the satellite to be simulated to be selected from 1 to 37. The associated signal level is set under LEVEL.

Note: *To avoid any damage to connected receivers, the user must ensure that the signal level used is not too high. A downstream attenuator pad must be connected to generate output levels below -144 dBm.*

Signals generated in this way can be recognized by a GPS receiver. However, since there are no real navigation data on the C/A code (as standard, a bit pattern with up to 16 characters is used as the navigation data source), only the signal level of the simulated satellite can be measured and displayed by the receiver.

A signal of this type is usually sufficient for performing simple function tests. It should be noted, however, that the receiver to be tested may have to be switched to a special test mode, since signals without correct navigation data are often not indicated (on a display, for example).

2. GPS signals with pseudo navigation data

Switching NAVIGATION DATA SOURCE over to DATA_LIST enables any data lists to be selected on SMIQ and used as navigation data. Real GPS navigation data with ephemeris and almanac information as generated with the AlmanacUploader PC tool from Rohde & Schwarz and transmitted to SMIQ, for example would be appropriate. The program can be downloaded from the Rohde & Schwarz Internet page (www.rohde-schwarz.com) under Application Notes 1GP46.

When pseudo-real navigation data with a length of 37500 bits (i.e. with a total signal time of 12.5 minutes) are used, for example, satellite-specific information on position and time is transmitted, which can be recognized by the receiver. In addition to information on the received satellite, almanac and ephemeris data can usually be output, thereby enabling the decoding of navigation data to be checked.

Note: *The GPS signal is cyclically repeated as a function of the TRIGGER MODE. When navigation data from data lists are used, this causes the transmitted GPS time to be set to its initial value for each new cycle.*

3. Doppler-shifted GPS signals

For enhanced receiver characteristics checking, a Doppler shift of the type that occurs with real GPS signals can also be simulated. The relevant change to the symbol rate of the C/A code is carried out automatically. The currently valid values for Doppler-shifted carrier frequency and symbol rate are displayed under RESULTING FREQUENCY and RESULTING SYMBOL RATE.

The simulation of Doppler-shifted GPS signals can be used to check the receiver characteristics under more realistic conditions than with zero Doppler. In contrast to the real system, however, the set Doppler frequency is fixed and must eventually be changed manually.

4. GPS signals with modified carrier frequency and symbol rate

Additional settings for carrier frequency and symbol rate can be made to perform more comprehensive receiver tests. However, these settings may result in signals that do not conform to GPS.

The basic carrier frequency without Doppler shift can be freely set under **FREQ**. The actual frequency output physically is yielded by the following equation

$$f = \text{FREQ} + f_{\text{Doppler}}$$

and is displayed under **RESULTING FREQUENCY**.

The symbol rate used for zero Doppler is set under **SYMBOL RATE**. Taking into account a Doppler shift, the actual symbol rate is determined by the following equation

$$f_{\text{Symbol}_{\text{resulting}}} = f_{\text{Symbol}_{\text{ZeroDoppler}}} * \left(1 + \frac{f_{\text{Doppler}}}{\text{FREQ}} \right)$$

and is given under **RESULTING SYMBOL RATE**.

Selecting the appropriate parameters enables the characteristics of the receiver (such as dependence of receiver synchronization on the symbol rate/carrier frequency ratio, etc.) to be easily checked.

2.21 Arbitrary Waveform Generator ARB

The option SMIQB60, a two-channel ARB generator, is an integrated I/Q modulation source of the SMIQ. Thus, arbitrary modulation signals such as COFDM, multicarrier or noise can be generated. The software WinQSIM enables the calculation of modulation signals and the loading of these signals into the instrument. Furthermore, signals which were calculated by a mathematical program such as Matlab may be transferred.

2.21.1 Function

Conventional ARB generators substantially consist of an output memory with series-connected D/A converter and analog filter. Due to the limited number of filters and their steepness the sampling rate often has to be set considerably higher than required by Nyquist's theorem, in order for the aliasing effects to be sufficiently suppressed by the analog filter. Fig. 2-214 shows these ratios for a 1-MHz sinewave signal. If a filter provides a cutoff-frequency of 11 MHz, a sampling rate of at least 12 MHz must be selected to make sure that the aliasing effects are suppressed sufficiently.

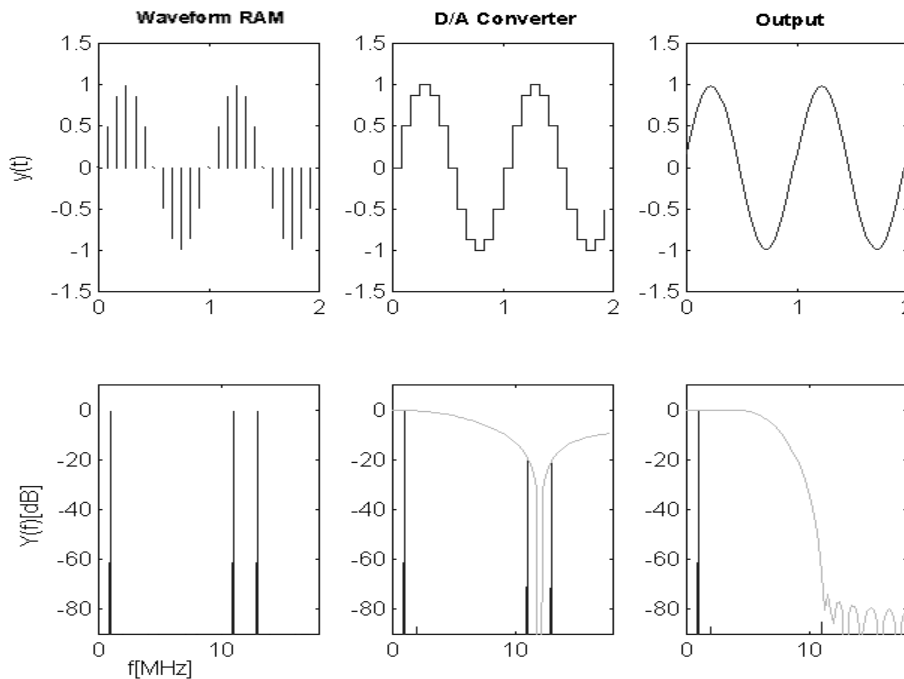

Fig. 2-214 Signal flow of ARB generator

This conception has been considerably improved in the option SMIQB60. The modulation signal is interpolated to a higher sampling rate by means of a very steep-edged, digital interpolation filter and is then output. The interpolation rate is set by the SMIQB60 automatically such that aliasing of the interpolated sampling rate is suppressed by the analog filter. This procedure offers the following advantages to the user:

1. Oversampling has to be selected such that the bandwidth of the interpolation filter exceeds that of the modulation signal. The following equation applies:

$$ov * int_bw \geq mod_bw,$$

$$ov == \text{Oversampling},$$

$$int_bw == 0.375, \text{ standardized bandwidth of the interpolation filter},$$

$$mod_bw == \text{bandwidth of the modulation signal standardized to symbol rate}$$

The following value is thus obtained for the digital standard W-CDMA with the baseband filter $\sqrt{\cos}$, $\alpha = 0.22$:

$$mod_bw = \frac{(1 + \alpha)}{2} = 0.61, \Rightarrow ov \geq \frac{0.61}{0.375} = 1.63.$$

2. Due to the reduced oversampling, the duration of the signal increases with constant number of sampling values. Accordingly, the number of sampling values decreases with constant signal duration. Usually, with conventional ARB generators, the minimum oversampling is limited to 4. Thus, provided that the above parameters of the W-CDMA system apply, the 512 ksamples of the SMIQB60 correspond to $4/1.63 * 512 = 1256$ kSamples memory in a conventional ARB generator.

The block diagram in Fig. 2-215 roughly illustrates the structure of the ARB generator.

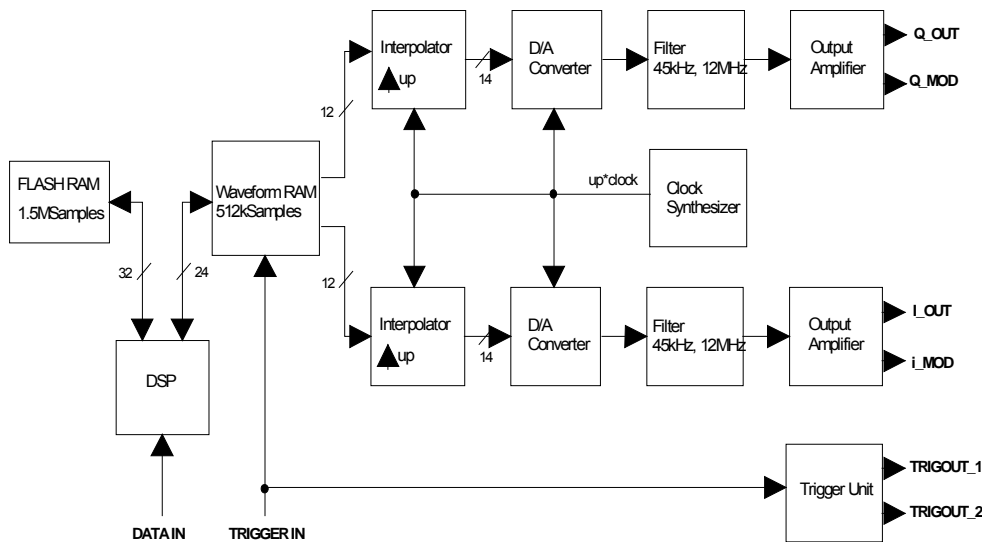

Fig. 2-215 Block diagram SMIQB60

The I/Q data are loaded by the host computer via the DATA IN interface to the DSP which passes them into a non-volatile FLASH RAM. The latter is organized in 22 blocks of 64ksamples, each. At least one block is occupied by each waveform. The I/Q data are subject to a convolution filter which limits the signal bandwidth. This is required for further processing.

If a waveform is selected, the I/Q data are loaded into the output memory. They are convoluted by a correction filter, which compensates all errors in the path to the I/Q modulator. In particular, the Si frequency response of the D/A converter as well as the frequency responses of the analog filter on the SMIQB60 and of the I/Q filter of the option SMIQB47 are corrected. Fig. 2-216 illustrates the further signal flow in the frequency and time domains.

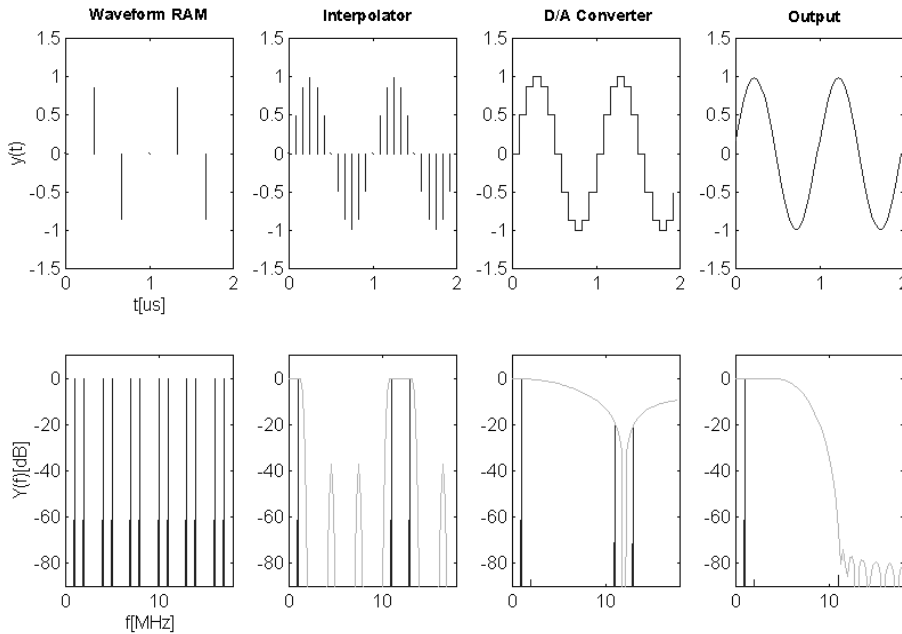

Fig. 2-216 Signal flow SMIQB60

A 1-MHz sinewave signal with $f_a = 3$ MHz is sampled by way of example. The sampling procedure causes aliasing to occur in the frequency range $(n \cdot 3 \pm 1)$ MHz. The following interpolation filter increases the sampling rate by the factor 4. This corresponds to a correct reconstruction of the additional sampling values in the time domain. Due to the sample-and-hold process at the output of the subsequent D/A converter, a stair-step signal is generated in the time domain which corresponds to a SI-weighting in the frequency domain. The analog filter compensates for the aliasing of the interpolated sampling rate, the output signal is a sinewave signal in the time domain. SMIQB60 automatically sets the interpolation rate such that aliasing is suppressed by the analog filter.

The sampling rate is increased internally by the factor 4, in order to avoid errors with CCDF determination of the waveform with low sampling rate.

The absolute value of the I/Q output signal is 0.5 Vs at 50Ω (= 0 dB) in Normal mode. This is the nominal output of the I/Q modulator. The output level may be varied in Manual mode between -6 dB and 3 dB in order to optimize the ACP in various channel offsets, e.g. The range above 0 dB is not specified, signal frequencies above 10 MHz may lead to a limitation.

The internal calibration of the SMIQB60, which is performed automatically with calibration of the vector modulation, corrects offset and gain errors to a minimum.

The trigger facilities of the SMIQB60 are similar to those of the data generator SMIQB11 (see Digital Modulation). The trigger generator consists of programmable counters which generate a periodic sequence with a pulse duty ratio of On Time/Off Time with settable start delay. E.g., to generate a slot trigger for a W-CDMA signal with a chip rate of 3.84 MHz, the following values are set:

t_{Slot} = Slot time

t_{Chip} = Chip time

t_a = Sampling time

$$t_{\text{Slot}} = 625\mu\text{s} = 2400 t_{\text{Chip}}, t_{\text{Chip}} = \text{ov} * t_a, \text{ov} = 2, \Rightarrow t_{\text{Chip}} = 4800 * t_a$$

On Time = 100 (for example) \Rightarrow Off Time = 4700.

The trigger signals are time-synchronous with the I/Q output signals. WinIQSIM supports the generation of predefined trigger signals (see Use of WinIQSIM Software).

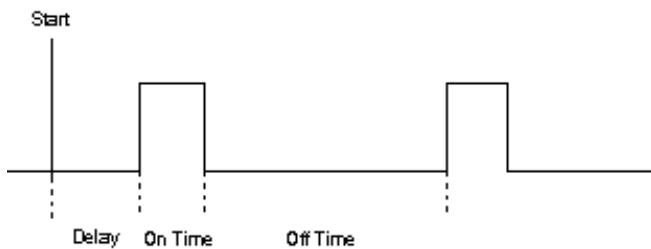

Fig. 2-217 Trigger signals SMIQB60

2.21.1.1 Use of WinIQSIM

The SMIQB60 is supported by WinIQSIM starting with version 3.30. Waveforms can be loaded via the IEC/IEEE bus into the FLASH memory, an individual operating menu allows for setting numerous SMIQ parameters. It must be noted that settings of WinIQSIM cannot be read from the waveform. WinIQSIM provides predefined settings for bit and symbol clock for the generation of trigger signals, slot and frame trigger and the restart signal for the BERT (SMIQB21). Si and filter compensation is not supported by WinIQSIM since these functions are carried out directly on the SMIQB60. Waveforms which contain these corrections may also be loaded in the SMIQB60. This is recognized and the internal correction filters are modified accordingly.

2.21.2 ARB MOD Menu

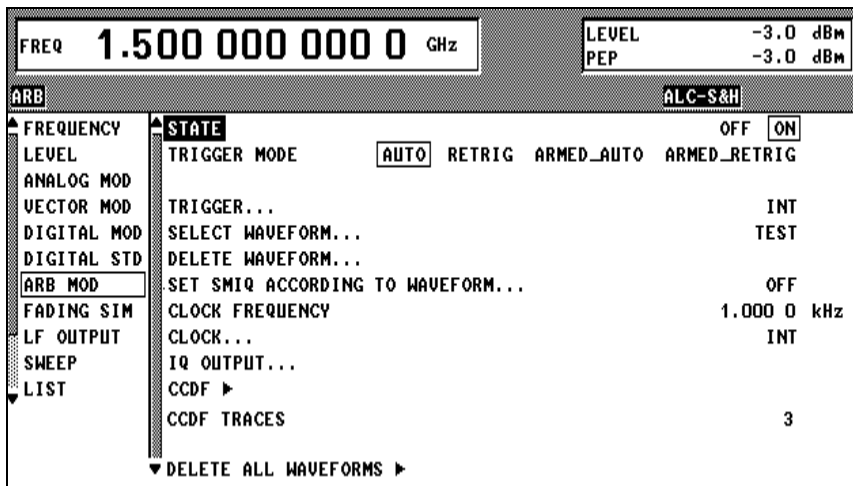

Fig. 2-218 ARB MOD menu

STATE

Switching on/off ARB function. The state is indicated in the status line.

ON

Loads the selected waveform in the output RAM and sets the module according to the current settings. This may last a few seconds depending on the length of the selected waveform. If vector modulation, digital modulation or digital standard were switched on, they are switched off automatically.

IEC/IEEE bus command :ARB:STAT ON

OFF

Modulation is switched off, output of ARB waveform stops.

IEC/IEEE bus command :ARB:STAT OFF

TRIGGER MODE

Configuration of run control of ARB mode.

AUTO

The calculated waveform (sequence) is output immediately and repeated in cycles. Trigger events are ignored.

IEC/IEEE bus command :ARB:SEQ AUTO

RETRIG

Cyclic repetition of output. A trigger event initiates a restart.

IEC/IEEE bus command :ARB:SEQ RETR

ARMED_AUTO

Only a trigger event initiates a start. Subsequent trigger events are ignored.

IEC/IEEE bus command :ARB:SEQ AAUT

ARMED_RETRIG

Like ARMED_AUTO. Each following trigger event initiates a new start.

IEC/IEEE bus command :ARB:SEQ ARET

EXECUTE TRIGGER ➤

Initiates a trigger to start the ARB sequence (not displayed with TRIGGER MODE = AUTO).

IEC/IEEE bus command :TRIG:DM:IMM

TRIGGER...	Opens a window for setting the trigger facilities and the trigger outputs.
SELECT WAVEFORM...	Opens a window for selection of an ARB waveform and for display of its parameters.
DELETE WAVEFORM...	Opens a window for selection of an ARB waveform to be deleted.
SET SMIQ ACCORDING TO WAVEFORM...	Opens a window for configuration of the automatic setting of SMIQ parameters.
CLOCK FREQUENCY	Input value for the sample clock. If the clock is supplied by an external source, the applied frequency must be entered here. IEC/IEEE bus command :ARB:CLOC 4.096MHz
CLOCK...	Opens a window for selection of the clock source and delay of the clock signal.
IQ OUTPUT...	Opens a window for entry of the IQ level and mode.
CCDF >	Display of the Complementary Cumulative Distribution Function of the waveform loaded.
CCDF TRACES	Entry of the number of CCDFs. 1 to 3 may be selected.
DELETE ALL WAVEFORMS >	All waveforms are deleted (after being confirmed by the user).

2.21.2.1 ARB MOD - TRIGGER Menu

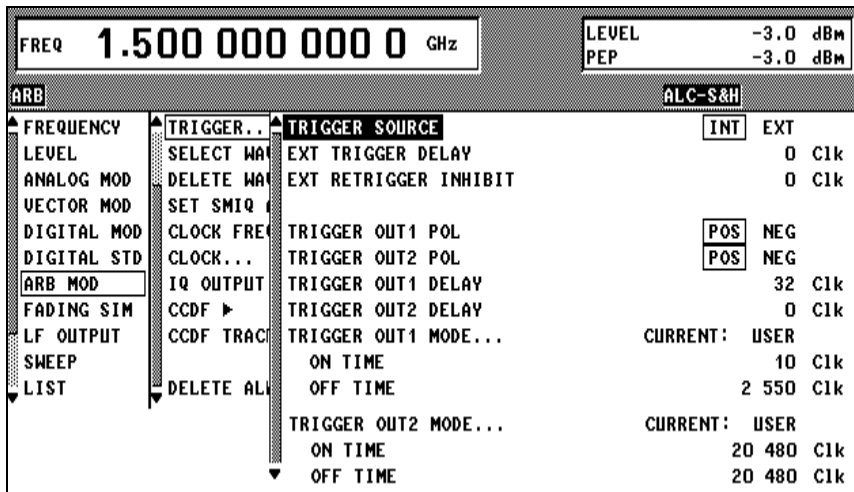

Fig. 2-219 ARB MOD - TRIGGER... menu

TRIGGER... Opens a window for setting the trigger facilities and the trigger outputs.

TRIGGER SOURCE

Configuration of trigger source.

INT Manually via EXECUTE TRIGGER or via software.

IEC/IEEE bus command :ARB:TRIG:SOUR INT

EXT Triggering with active edge at input socket.

IEC/IEEE bus command :ARB:TRIG:SOUR EXT

EXT TRIGGER DELAY

Delays the start of sequence by the indicated samples after occurrence of an external trigger event. The resolution is 2 samples with clock rates (CLOCK) above 20 MHz (otherwise, 1 sample).

IEC/IEEE bus command :ARB:TRIG:DEL 234

EXT RETRIGGER INHIBIT

Retriggering is inhibited until the sequence has reached the indicated sample.

IEC/IEEE bus command :ARB:TRIG:INH 345

TRIGGER OUT1(2) POL

Signal polarity at the trigger outputs.

POS active state: positive voltage

IEC/IEEE bus command
:ARB:TRIG:OUTP1:POL POS

NEG active state: 0 or lower voltage

IEC/IEEE bus command
:ARB:TRIG:OUTP2:POL NEG

TRIGGER OUT1(2) DELAY

Delay of the supplied trigger signals by the set number of samples.

IEC/IEEE bus command :ARB:TRIG:OUTP:DEL 765

(TRIGGER...) TRIGGER OUT1(2) MODE

The user may select one of the displayed modes for generation of the trigger output signals. Depending on the system, WinIQSIM can calculate clock signals for BIT, SYMBOL, SLOT, FRAME and the restart signal (sequence) and transmit them together with the waveform. These modes set the counters for ON TIME and OFF TIME (see below). The names are defined as modes by WinIQSIM, stored in the waveform where they can be selected. The maximum number of defined counters is 4. It may occur that only the SEQUENZ and USER modes can be provided since the entirety of modes is not always available for all systems.

- BIT_CLK** edge at beginning of each bit
- SYMB_CLK** edge at beginning of each modulation symbol
- SLOT_CLK** edge at beginning of each slot
- FRAM_CLK** edge at beginning of each frame
- SEQUENZ** edge at beginning of each sequence (may, e.g., be used as restart signal for BERT)
- PULSE** pulse defined by WinIQSIM user
- USER** The user defines a pulse by means of the parameters for ON and OFF TIME.

IEC/IEEE bus command :ARB:TRIG:OUTP:MODE USER

....ON TIME

Length of the active state of the output trigger signals indicated as number of samples. Can be modified only, if MODE = USER. This time is repeated after OFF TIME has run off.

IEC/IEEE bus command :ARB:TRIG:OUTP:ONT 3789

....OFF TIME

Length of the non-active state of the output trigger signals indicated as number of samples. Can be modified only, if MODE = USER.

IEC/IEEE bus command :ARB:TRIG:OUTP2:OFFT 639

2.21.2.2 ARB MOD - SELECT WAVEFORM Menu

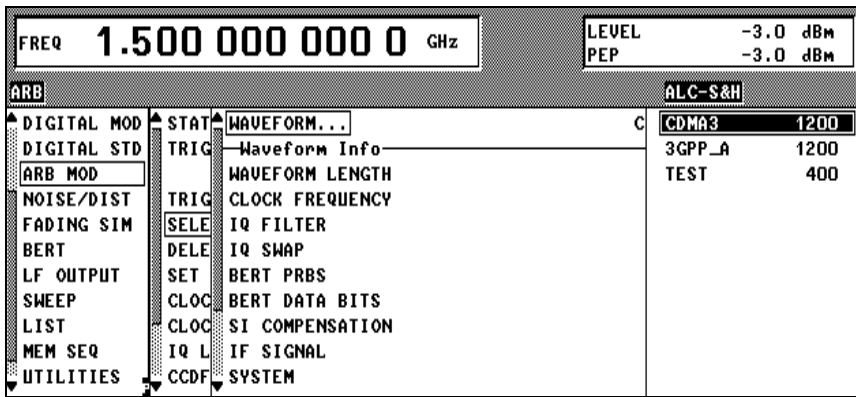

Fig. 2-220 ARB MOD - SELECT WAVEFORM... menu

SELECT WAVEFORM... Opens a window for selection of an ARB waveform and for display of its parameters.

WAVEFORM A list of ARB waveforms is offered to the right. The length of the waveforms is indicated in samples. The user selects a waveform from this list, which then becomes the active waveform. Further information on this waveform is then provided.

IEC/IEEE bus command :ARB:WAV:SEL 'TEST'

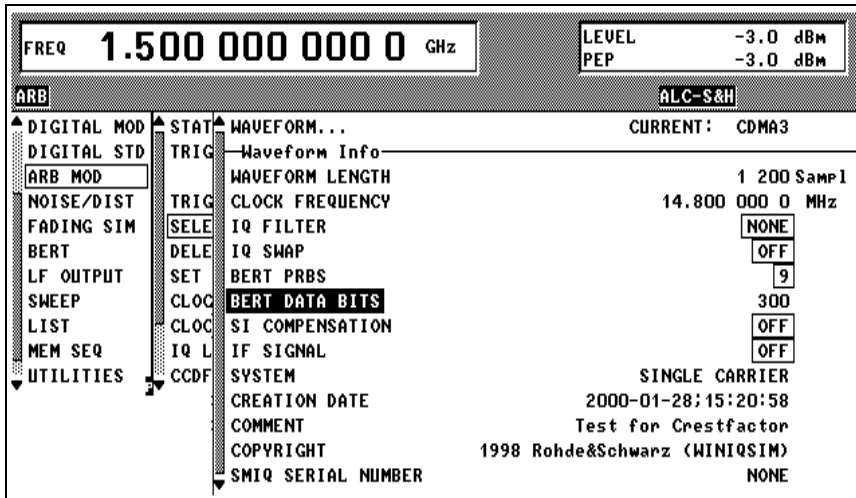

Fig. 2-221 ARB MOD - WAVEFORM INFO menu

SELECT WAVEFORM... ----Waveform Info -----

These lines are for display purposes only, they cannot be modified. They are filled with values from the active waveform when opening the menu. After being confirmed by the user they are updated via (SELECT). Setting parameters are not set until this confirmation and errors are signaled with conflicts, when the menu is left via RETURN (see SET SMIQ ACCORDING TO WAVEFORM menu). IEC/IEEE bus commands have the form of queries.

SELECT WAVEFORM...	WAVEFORM LENGTH	<p>Displays the number of samples contained in the waveform.</p> <p>IEC/IEEE bus command :ARB:WAV:POIN?</p>
	CLOCK FREQUENCY	<p>Provides the sample rate which the waveform has been generated for. This value is always entered as CLOCK FREQUENCY parameter of the ARB MOD menu with loading a waveform (independent of SET SMIQ ACCORDING TO WAVEFORM).</p> <p>IEC/IEEE bus command :ARB:WAV:TAG? 'CLOCK'</p>
	IQ FILTER	<p>Displays the setting used for calculation of the waveform in WinIQSIM. WinIQSIM sets this value to 0 (OFF), if the waveform is calculated for the SMIQ in particular. If, however, a compensation for an IQ filter is taken into account (for example when calculating the waveform for AMIQ), the compensation is automatically counted back by the SMIQ. Independently from this setting, however, a suitable IQ filter can be selected in the SMIQ. Compensation of the IQ filter is executed automatically by the SMIQ.</p> <p>The value of the waveform is used in the VECTOR MOD menu for the IQ filter if this is enabled in the SET SMIQ ACCORDING TO WAVEFORM menu.</p> <p>IEC/IEEE bus command :ARB:WAV:TAG? 'LACP FILTER'</p>
	IQ SWAP	<p>Indicates the setting used with the waveform calculation in WinIQSIM. The value is used in the VECTOR MOD menu for the IQ SWAP setting after enabling in the SET SMIQ ACCORDING TO WAVEFORM menu.</p> <p>IEC/IEEE bus command :ARB:WAV:TAG? 'IQ SWAP'</p>
	BERT PRBS	<p>Displays the type of PRBS used for the data in WinIQSIM, if the data have been prepared for a BER measurement.</p> <p>The setting is used in the BERT menu for setting the type of PRBS after clearing in the SET SMIQ ACCORDING TO WAVEFORM menu. A waveform cannot be used always for a BER measurement. If not, the display reads NONE.</p> <p>IEC/IEEE bus command :ARB:WAV:TAG? 'PRBS LENGTH'</p>
	BERT DATA BITS	<p>Indicates the number of data bits in a waveform, if the data have been prepared for a BER measurement by WinIQSIM. If the waveform cannot be used for a BER measurement, zero is displayed, here.</p> <p>IEC/IEEE bus command :ARB:WAV:TAG? 'BERT DATABITS'</p>

(SELECT WAVEFORM...) SI COMPENSATION	<p>ON indicates that the SI compensation of WinIQSIM was taken into account with calculation of the waveform. Since the SMIQ, independent of that calculation, also takes into account the SI compensation, it is disabled in WinIQSIM, if the waveform is calculated particularly for the SMIQ. It is however counted back by the SMIQ, if it was taken into account e.g., with calculation of a waveform for the AMIQ.</p> <p>IEC/IEEE bus command :ARB:WAV:TAG? 'SI COMPENSATED'</p>
IF SIGNAL	<p>ON indicates that the waveform was converted into an IF signal by WinIQSIM. This signal is not intended to be used as IQ vector. However, the user may derive it from the I-channel output and apply as IF signal.</p> <p>IEC/IEEE bus command :ARB:WAV:TAG? 'IF_SIGNAL'</p>
SYSTEM	<p>Indicates the standard used to calculate the waveform in WinIQSIM. The following standards have been defined: Single Carrier, Multi Carrier, Multi Carrier Mixed Signal, 3GPP W-CDMA, IS-95, CDMA2000 and Import.</p> <p>IEC/IEEE bus command :ARB:WAV:TAG? 'SYSTEM'</p>
CREATION DATE	<p>Displays the creation date of the waveform. Provides the user with information and is added automatically with calculation in WinIQSIM.</p> <p>IEC/IEEE bus command :ARB:WAV:TAG? 'DATE'</p>
COMMENT	<p>Is provided for information purposes and may be entered as comment text in WinIQSIM.</p> <p>IEC/IEEE bus command :ARB:WAV:TAG? 'COMMENT'</p>
COPYRIGHT	<p>Indicates whether the waveform was generated using the protected software WinIQSIM.</p> <p>IEC/IEEE bus command :ARB:WAV:TAG? 'COPYRIGHT'</p>
SMIQ SERIAL NUMBER	<p>Is important, if the wave was generated in WinIQSIM with IQ FILTER = ON. In this case, filter coefficients have been used for compensation, which are best only for SMIQs with this serial number.</p>

2.21.2.3 ARB MOD - DELETE WAVEFORM Menu

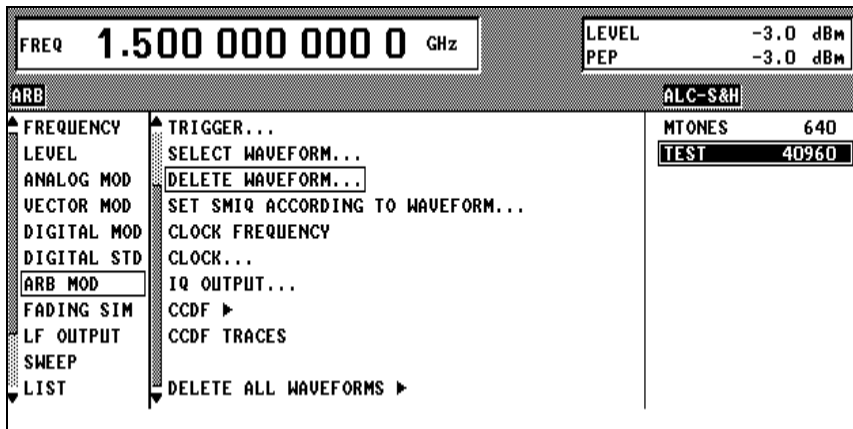

Fig. 2-222 ARB MOD - DELETE WAVEFORM... menu

DELETE WAVEFORM... Opens a window for selection of an ARB waveform to be deleted. A list of ARB waveforms including information on their lengths is offered to the right, where the user may select a waveform.

IEC/IEEE bus command :ARB:WAV:DEL 'TEST'

2.21.2.4 ARB MOD - SET SMIQ ACCORDING TO WAVEFORM Menu

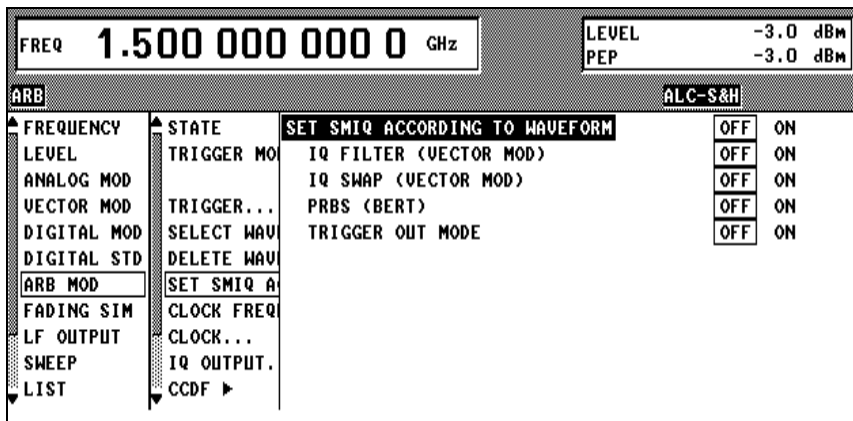

Fig. 2-223 ARB MOD - SET SMIQ ACCORDING TO WAVEFORM menu

SET SMIQ ACCORDING TO WAVEFORM... Opens a window for configuration of the automatic setting of SMIQ parameters.

SET SMIQ ACCORDING TO WAVEFORM ON In any case, settings on the SMIQ are made based on the information from the waveform to be loaded.

IEC/IEEE bus command :ARB:ASET:STAT ON

OFF No settings are made, even if the following configurations are set ON. CLOCK FREQUENCY in the ARB MOD menu is always set.

IEC/IEEE bus command :ARB:ASET:STAT OFF

(SET SMIQ ACCORDING TO WAVEFORM...) ...IQ FILTER (VECTOR MOD)

The parameter IQ FILTER (filter of LACP Option SMIQB47) is set in the VECTOR MOD menu. If a waveform in WinIQSIM was compensated with the frequency responses of this filter, it should be switched on. A warning is output, if the waveform is compensated, however, this compensation does not apply for an SMIQ of this serial number or if the option is not fitted to the SMIQ.

ON Parameter is set
IEC/IEEE bus command
:ARB:ASET:DM:IQF ON

OFF Parameter is not set
IEC/IEEE bus command
:ARB:ASET:DM:IQF OFF

...IQ SWAP (VECTOR MOD)

The IQ SWAP parameter in the VECTOR MOD menu is set. If a waveform has been generated in WinIQSIM for this mode, it should be switched on. A warning is output, if the parameter is not set as indicated in the waveform.

ON Parameter is set
IEC/IEEE bus command
:ARB:ASET:DM:IQSW ON

OFF Parameter is not set
IEC/IEEE bus command
:ARB:ASET:DM:IQSW OFF

...PRBS (BERT)

The type of PRBS in the BERT menu is set. If a waveform has been generated in WinIQSIM with this PRBS, the latter should be selected with BER measurement. A warning is output, if the parameter is not set as indicated in the waveform.

ON Parameter is set
IEC/IEEE bus command
:ARB:ASET:BERT:TYPE ON

OFF Parameter is not set
IEC/IEEE bus command
:ARB:ASET:BERT:TYPE OFF

...TRIGGER OUT MODE

The parameters TRIGGER OUT1 MODE and TRIGGER OUT2 MODE in the ARB MOD TRIGGER... menu are set. Thus, the user can select the function of the SMIQ trigger outputs in WinIQSIM (see TRIGGER menu).

ON Parameter is set
IEC/IEEE bus command
:ARB:ASET:TRIG:MODE ON

OFF Parameter is not set
IEC/IEEE bus command
:ARB:ASET:TRIG:MODE OFF

2.21.2.5 ARB MOD - CLOCK... Menu

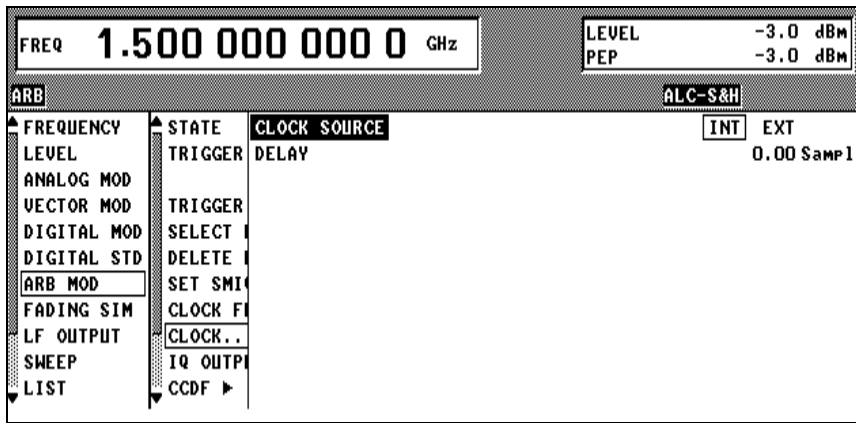

Fig. 2-224 ARB MOD - CLOCK... menu

CLOCK... Opens a window for selection of the clock source and delay of the clock signal.

CLOCK SOURCE Defines the source for the sample clock.

INT Clock is generated internally.
IEC/IEEE bus command :ARB:CLOC:SOUR INT

EXT Clock must be applied at the socket.
IEC/IEEE bus command :ARB:CLOC:SOUR EXT

DELAY Delay of the modulation signal against the clock signal. This may be used, e.g., for synchronization with a second instrument, to obtain time-synchronous modulation signals of both instruments.
IEC/IEEE bus command :ARB:CLOC:DEL 0.55

2.21.2.6 ARB MOD - IQ OUTPUT... Menu

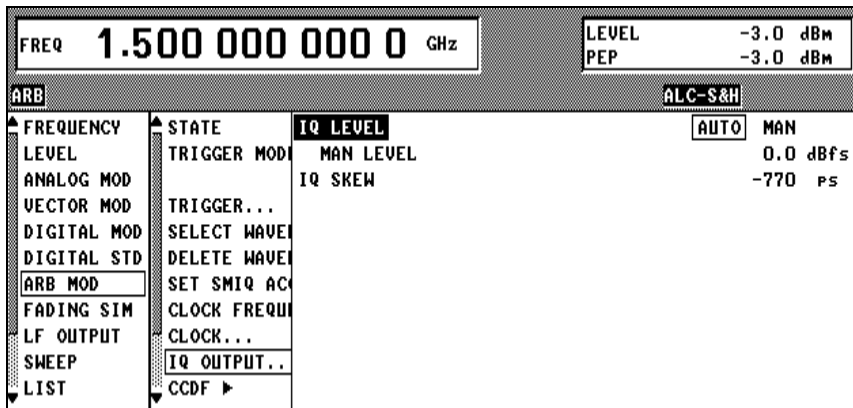

Fig. 2-225 ARB MOD - IQ OUTPUT... menu

IQ OUTPUT... Opens a window for entry of the IQ level and automatic level setting.

IQ LEVEL

Defines the operating mode for setting the IQ level.

AUTO The level is set automatically to a maximum sum vector of 0.5 V for maximum input level of the IQ modulator. The subsequent level entry is not effective.

IEC/IEEE bus command

:ARB:IQ:LEV:MODE AUTO

MAN The level is set using the level entry below. The instrument data can not be guaranteed for entry values above 0 dB, since the output level is limited. However, the signal-to-noise ratio, e.g., may thus be increased.

IEC/IEEE bus command

:ARB:IQ:LEV:MODE MAN

MAN LEVEL

Indicates the IQ level referred to maximum voltage.

Range: -6 to 3 dBfs

IEC/IEEE bus command :ARB:IQ:LEV -2.5DB

IQ SKEW

Determines the delay between I and Q channel. Positive values delay I against Q.

IEC/IEEE bus command :ARB:IQ:SKEW -250ps

2.22 External Modulation Source AMIQ

AMIQ from Rohde&Schwarz is now available as an external source for I/Q modulation signals. The generated signals are provided by the unit at modulation outputs I and Q on the front panel. The signals can be fed to modulation inputs I and Q of SMIQ.

With vector modulation mode activated, SMIQ modulates (I/Q modulation) the modulation signals generated by AMIQ onto the RF carrier.

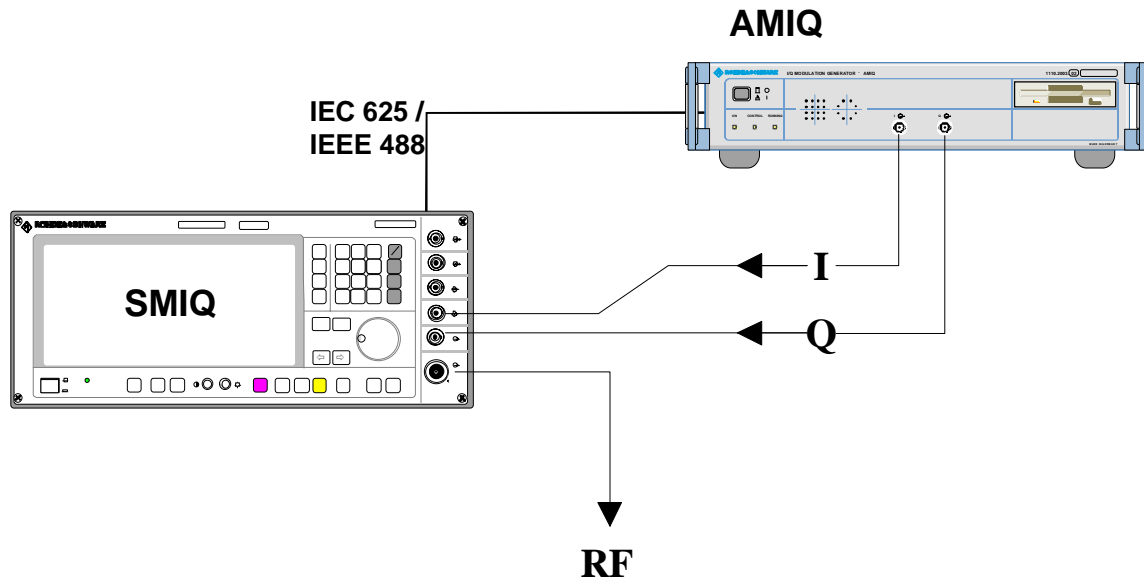

Fig. 2-226 Vector modulation with an external AMIQ

Menu VECTOR MOD provides access to settings required for vector modulation. Settings for generating the modulation signals are made in menu AMIQ CTRL. This menu allows to set the most important parameters of AMIQ via the remote-control interface IEC625/IEEE488. The IEC/IEEE-bus address of AMIQ is given in menu UTILITIES / SYSTEM / GPIB.

Note: Menu AMIQ CTRL is masked out when SMIQ is delivered. It has to be switched on in menu UTILITIES / INSTALL.



Complex signal data are created on the PC using Windows software WinIQSIM.

1. If WinIQSIM and AMIQ are linked via IEC/IEEE-bus or RS232 interface, signal data can be fully stored as waveform file on the hard disk of AMIQ. Signal data are then loaded from SMIQ to AMIQ by means of the following commands: `SELECT WAVEFORM/EXECUTE BATCH ... DRIVE, HARDDISK` and by selection of the file name.
2. If there is no remote-control connection between WinIQSIM and AMIQ, signal data up to 300.000 samples can be stored as waveform file on floppy. Signal data are then loaded from SMIQ to AMIQ by means of the following commands:
`SELECT WAVEFORM/EXECUTE BATCH ... DRIVE, FLOPPY.`

A faster access is possible if signal data are stored as batch files on a floppy. The floppy is then inserted into AMIQ and the batch file is called up from SMIQ by means of the following commands:

`SELECT WAVEFORM/EXECUTE BATCH ...EXECUTE BATCH FROM FLOPPY.`

The signal data are stored as waveform file on the AMIQ hard disk under the name defined in WinIQSIM. After that, the waveform file can be loaded as described under 2.

For generation of waveform files for AMIQ see chapter on "Menu item AMIQ" in the WinIQSIM manual".

The system consisting of SMIQ as modulation coder, AMIQ as source for baseband signals and WinIQSIM for signal data configuration makes the generation of any complex, digitally modulated communication signals convenient and easy.

To remote control AMIQ via IEC625/IEEE488, SMIQ is configured as a system controller. In the normal mode, SMIQ is configured as a talker/listener.

In general, only one unit can be the system controller on the bus.

With menu AMIQ CTRL called up, SMIQ is automatically configured as the controller. If this is not possible since for example another unit (eg a PC) has already taken over the controller function, menu AMIQ CTRL will not be opened and an error message will be issued.

When menu AMIQ CTRL is closed, SMIQ will again switch to the talker/listener mode.

Menu selection: AMIQ CTRL

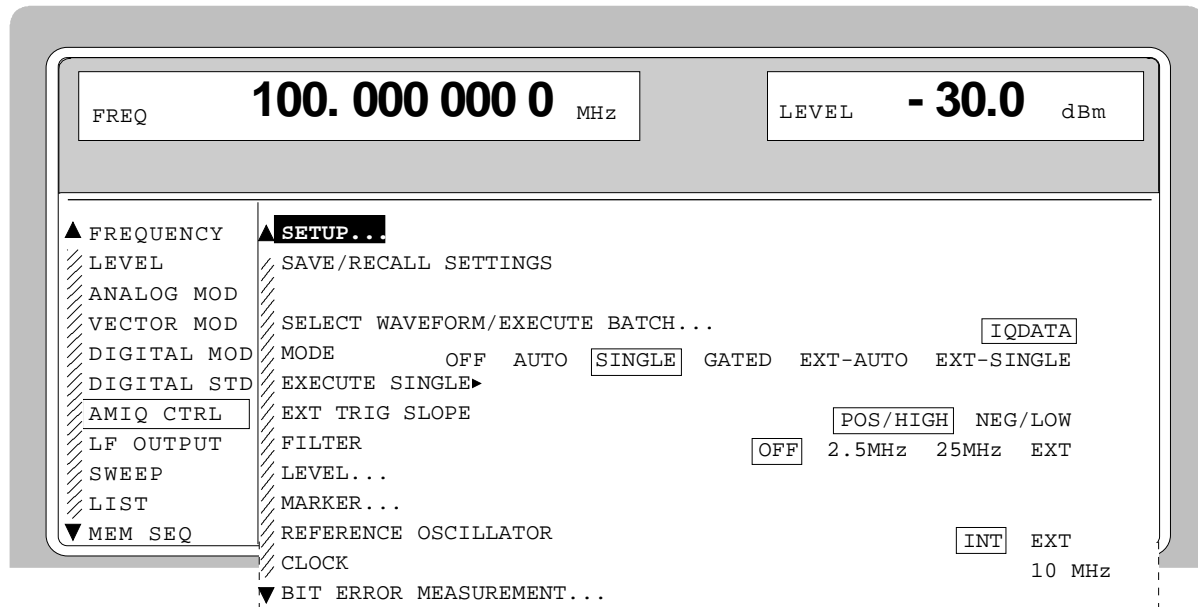

Fig. 2-227 Menu AMIQ CTRL (presetting depends on AMIQ)

SETUP...

Opens a window to set the basic configuration of AMIQ.

The window offers functions to perform automatic adjustment, fine adjustment, selftest and to reset to a defined basic state.

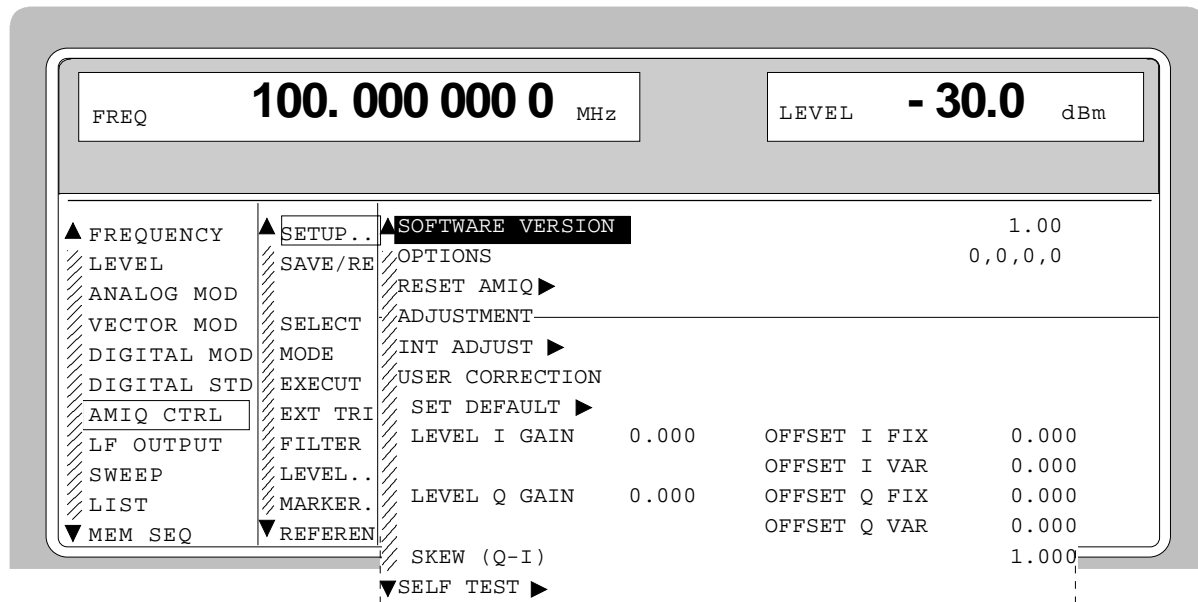

Fig. 2-228 Menu AMIQ CTRL -SETUP...

(SETUP...)	SOFTWARE VERSION	Display of the current AMIQ firmware version AMIQ.
	OPTIONS	Display of AMIQ options.
	RESET AMIQ ►	Resets AMIQ to a defined basic state.
	INT ADJUST ►	Starts automatic self-adjustment of AMIQ: <ul style="list-style-type: none"> – Level adjustment (I/Q) to 1.0 Volt when fully equipped – Offset adjustment (I/Q) to a minimum – Fine adjustment of reference oscillator to 10 MHz – Minimization of delay between I and Q channel
	USER CORRECTION	The user correction allows the fine adjustment of level and offset of the I and Q channel as well as the minimization of the delay between the channels of the complete system. The internal adjustment (INT ADJUST) is not taken into account.
	SET DEFAULT ►	Resets the user correction to the default values. This applies to the following parameters: <ul style="list-style-type: none"> – LEVEL I GAIN (*) – OFFSET I FIX (*) – OFFSET I VAR (**) – LEVEL Q GAIN (*) – OFFSET Q FIX (*) – OFFSET Q VAR (**) – SKEW (I-Q) <p style="margin-left: 20px;">* These parameters will only be effective provided that a fixed level of 0.5 V/50 Ohm has been assigned to the corresponding channel. For variable levels, the settings of these parameters are ineffective. A correction of the gain factor is possible when the level is entered.</p> <p style="margin-left: 20px;">** These parameters are only effective in case of variable levels and have no effect in case of fixed levels.</p> <p style="margin-left: 20px;">The level is set in the submenu LEVEL... (LEVEL I/Q = 0.5V/50 Ohm or VAR).</p>
	LEVEL I GAIN	Fine adjustment of gain factor for I channel in case of fixed level. Relative gain factors in the range $\pm 10\%$ can be entered.
	OFFSET I FIX	Fine adjustment of level offset for the I channel in case of fixed level. The relative factors ± 1.0 correspond to an offset detuning of ± 30 mV.

(SETUP...)	OFFSET I VAR	Fine adjustment of level offset for the I channel in case of variable level. The offset detuning depends on the of the mechanical attenuator setting of AMIQ. See AMIQ manual, section SOURce - Hardware Settings.
	LEVEL Q GAIN	Fine adjustment of gain factor for the Q channel in case of fixed level.
	OFFSET Q FIX	Fine adjustment of level offset for the Q channel in case of fixed level.
	OFFSET Q VAR	Fine adjustment of level offset for the Q channel in case of variable level.
	SKEW (Q-I)	Defining the delay between the I and Q channel. Positive values delay I compared with Q. The delay can be modified by entering the relative factors ± 1.0 in a range of approx. ± 1 ns at a resolution of 10 ps.
	SELF TEST ►	Triggers the internal AMIQ selftest which comprises the following: <ul style="list-style-type: none"> – memory test of the output memory. – control of components of analog hardware and check of signal paths by means of the built-in diagnostic A/D converter.

SAVE/RECALL SETTINGS... Opens a window to save/load/delete a maximum number of 100 AMIQ setups.

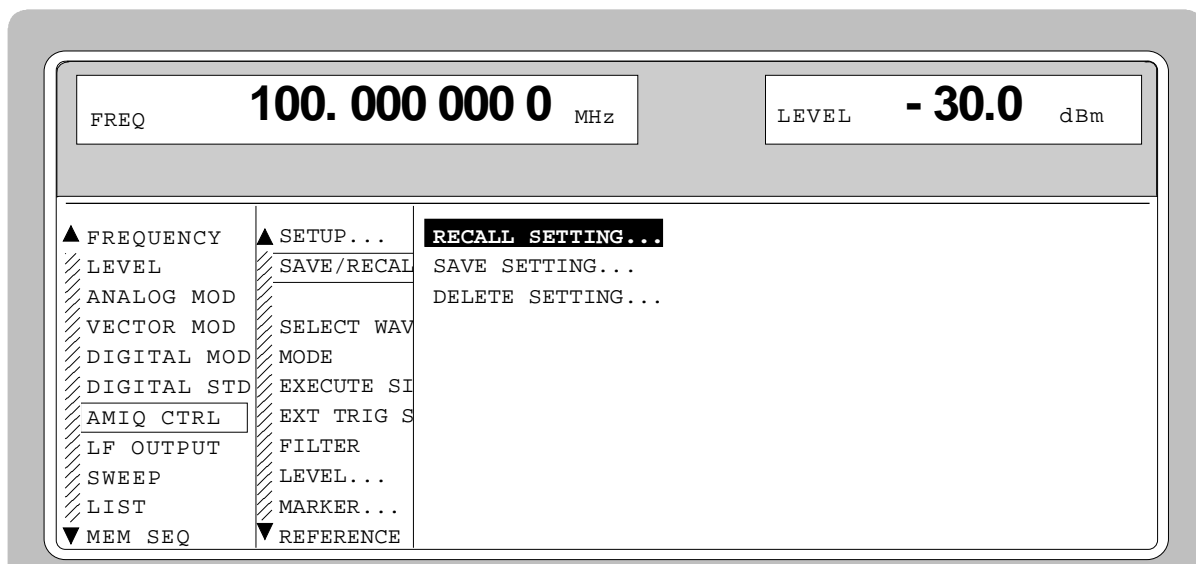

Fig. 2-229 Menu AMIQ CTRL -SAVE/RECALL SETTINGS...

(SAVE/RECALL SETTINGS...) **RECALL SETTING...** Selects and loads a stored AMIQ setup. The available setups are offered in a select window.

(SAVE/RECALL SETTINGS...)

SAVE SETTING...

Saves the current AMIQ setup. An already existing setup can be selected and overwritten in a select window. A new setup is created by selecting **CREATE NEW SETTING ▶**. SMIQ automatically offers SETTx with xx being in the range from 0 to 99. This name can be modified any time as required.

DELETE SETTING...

Deletes AMIQ setups. The available setups are offered in a select window.

SELECT WAVEFORM/ EXECUTE BATCH...

Opens a window to

- load signal data from diskette or hard disk into the AMIQ internal memory,
- transfer signal data generated by WinIQSIM to the AMIQ hard disk,
- display current signal data.

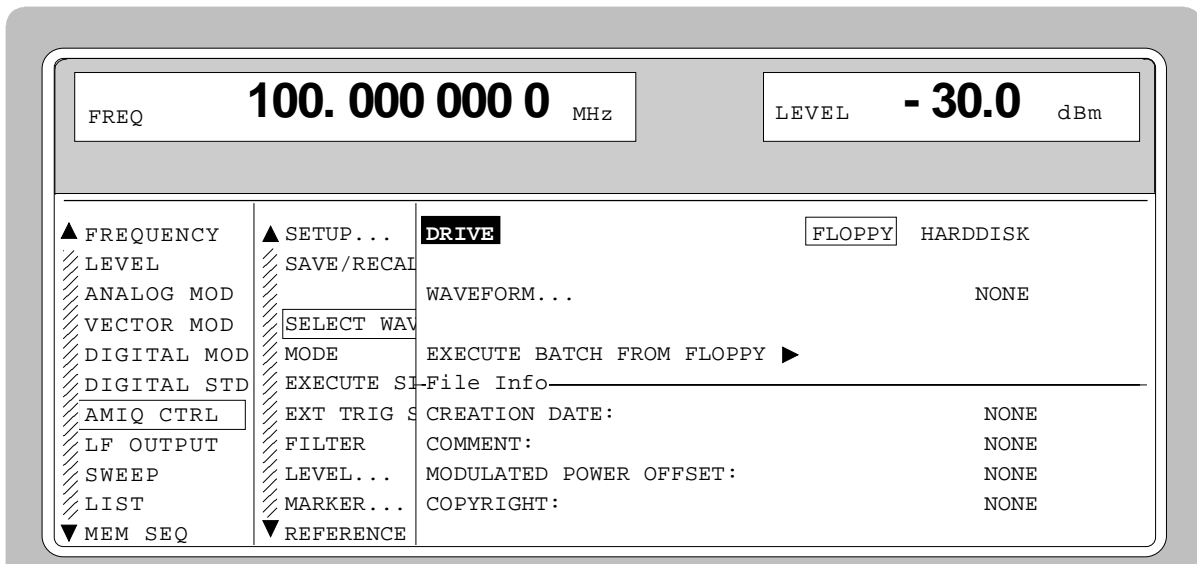

Fig. 2-230 Menu AMIQ - SELECT WAVEFORM/EXECUTE BATCH...

(SELECT WAVEFORM/ EXECUTE BATCH...)

DRIVE

Selects storage medium with the signal data to be activated.

DIRECTORY...

Selects the directory comprising the required signal data on the AMIQ hard disk. The directory structure is freely selectable and can be modified with WinIQSIM. SMIQ does not allow to change the directory structure. The menu item is only visible with DRIVE = HARDDISK.

(SELECT WAVEFORM/ EXECUTE BATCH...)	WAVEFORM...	<p>Selects the signal data to be loaded. The data available on diskette or hard disk are offered in a select window. After selecting the signal data, the following actions are performed:</p> <ol style="list-style-type: none"> 1. stopping the currently active signal output, 2. preparing the selected signal data, 3. further procedure is according to parameter MODE in main menu.
	SET SMIQ LEVEL ACCORDING TO WAVEFORM	<p>Waveform files may contain information on LEVEL OFFSET and CREST FACTOR. If this function is active, these values are set automatically upon loading the waveform. If no waveform is loaded, they are set to zero.</p>
	EXECUTE BATCH FROM FLOPPY ►	<p>Executes the batch file WINIQSIM.IEC generated by WinIQSIM from diskette. The signal data including the given directory structure are stored on the AMIQ hard disk.</p> <p>The directory structure is defined by the user during the generation of the diskette.</p>
	FILE INFO	<p>All menu entries displayed under FILE INFO are not editable. The file info (date, comment and origin as well as power offset of modulation) from the selected files is displayed.</p>
MODE		<p>Configuration of trigger conditions for signal output. Any change in the trigger conditions resets the signal output and starts it again. Retriggering a running signal output is inhibited.</p>
	OFF	Stops the signal output, output of the idle signal.
	AUTO	Continuous signal output, trigger events are ignored.
	SINGLE	<p>Prepares a single signal output. The idle signal is output first. Signal output is started via menu item EXECUTE SINGLE ►. After completion of the signal output, the idle signal is output. External trigger events are ignored.</p>
	GATED	<p>The level of the signal applied to the trigger input controls the output.</p> <p>If the level (HIGH/LOW) set under EXT TRIG SLOPE is applied, the signal output will be restarted and the signal will be output continuously. If the level set under EXT TRIG SLOPE is not applied, the output will be interrupted and the idle signal will be output.</p>
	EXT-AUTO	<p>Continuous signal output. The idle signal is output first. The signal output is started via an external trigger event. Further trigger events are ignored. A signal slope whose polarity is configured in menu item EXT TRIG SLOPE (POS/NEG) is taken as a trigger event.</p>
	EXT-SINGLE	<p>Prepares a single signal output. The idle signal is output first. The signal output is started via an external trigger event. After completion of the signal output, the idle signal is output until the next trigger event is obtained.</p>

EXECUTE SINGLE ▶ Starts a single signal output. This menu item is displayed only with MODE = SINGLE.

EXT TRIG SLOPE Selects the polarity of an external trigger signal at connector TRIG. This external trigger signal generates a trigger event. This setting has an effect on modes GATED (HIGH/LOW), EXT-AUTO and EXT-SINGLE (POS/NEG).

FILTER Configuration of reconstruction filters for signal paths I and Q.

OFF	Output of unfiltered I/Q signals
2.5 MHz	Loop in of the internal 2.5 MHz lowpass filter.
25 MHz	Loop in of the internal 25 MHz lowpass filter
EXT	Loop in of external bandpass filters for the I and Q channel. For a detailed specification of the filter see AMIQ manual, section Signal Inputs and Outputs.

Note: *With external filtering it has to be made sure that a filter is connected to both filter inputs I and Q on the rear of AMIQ. The two signal outputs can be switched off completely during external filtering provided that no filter is connected to the corresponding filter input.*

LEVEL... Opens a window to set the level for the two signal paths I and Q.

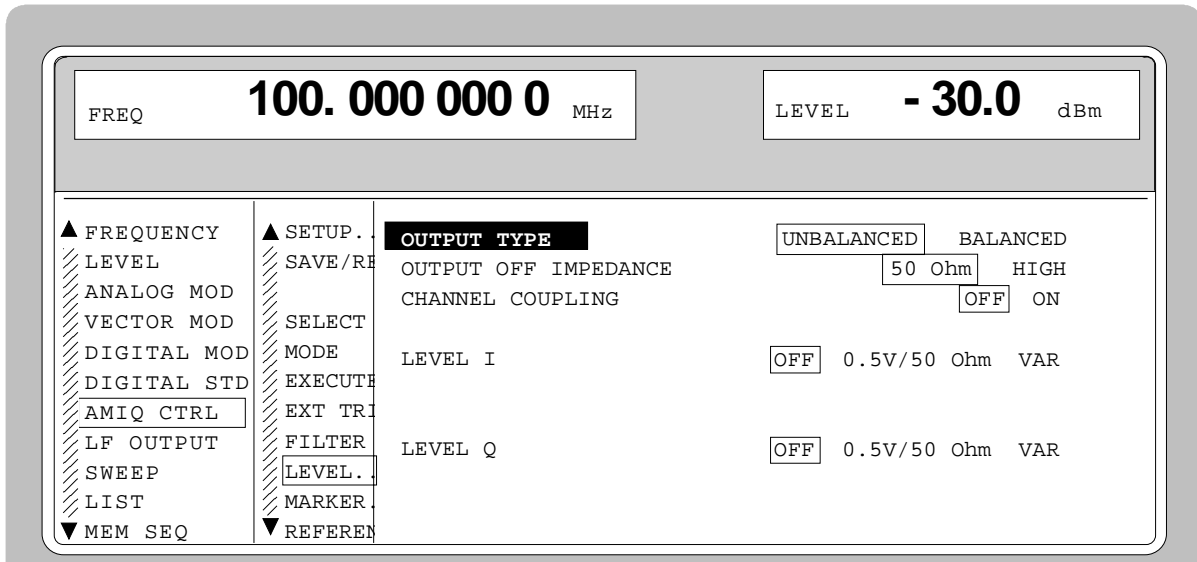

Fig. 2-231 Menu AMIQ CTRL -LEVEL...

(LEVEL...)	OUTPUT TYPE	<p>This command switches between ground-referred outputs I and Q (UNBalanced) and differential I and Q outputs (BALanced).</p> <p>UNBalanced The level indicated for LEVEL I/Q (0 V to 1 V) is the amplitude V_p of the inner conductor of BNC connectors I and Q referred to ground, measured on a terminating impedance of 50 Ω.</p> <p>BALanced The level indicated for LEVEL I/Q (0 V to 4 V) is the amplitude V_{pp} between the inner conductors of BNC connectors I and \bar{I} as well as Q and \bar{Q} with a high-impedance termination.</p>
	OUTPUT OFF IMPEDANCE	<p>This command sets the impedance of the AMIQ outputs disconnected by LEVEL I/Q=OFF, with or without option AMIQ-B2 (differential outputs). The output impedance is indicated for both channels. If the command LEVEL I/Q != OFF is activated when the AMIQ outputs are switched on, this is equivalent to presetting which will only have an effect when the AMIQ outputs are turned off.</p> <p>50Ω Corresponds to the setting LEVEL I/Q VAR = 0 V.</p> <p>HIGH The output connectors are isolated with a relay and become high impedance.</p>
	DIGITAL OUTPUT	Switching the digital outputs on or off (option AMIQ-B3).
	CHANNEL COUPLING	<p>Switches on/off coupling of level setting for the I and Q channel.</p> <p>OFF Separate setting of the two channels</p> <p>ON Combined setting of the two channels</p>
	LEVEL I/Q	<p>Selection of level setting for the I/Q channel.</p> <p>OFF Switch-off of output</p> <p>0.5V/50Ω Fixed setting of 1 V_{pp} into 50 Ω</p> <p>VAR Variable setting of level</p> <p>Note: <i>The fine setting of level and offset can be made in menu AMIQ CTRL - SETUP....</i></p>
	LEVEL	Variable setting of level for the I/Q channel. This menu item is displayed only with LEVEL I/Q = VAR.

(LEVEL) **BIAS**

DC offset in I/Q channel for the BALANCED setting. The indicated level remains the same with the I/Q output (LEVEL I/Q = OFF) turned off, provided the output impedance was prior set to 50 Ω with the command OUTPUT OFF IMPEDANCE. If the output impedance is set to HIGH with the I/Q output off, the output connector is isolated with a relay and the BIAS setting has no effect. (Only with option AMIQ-B2).

MARKER... Opens a window to configure the four binary marker outputs of AMIQ (eg to control power ramping of SMIQ), see AMIQ operating manual, section Marker Outputs.

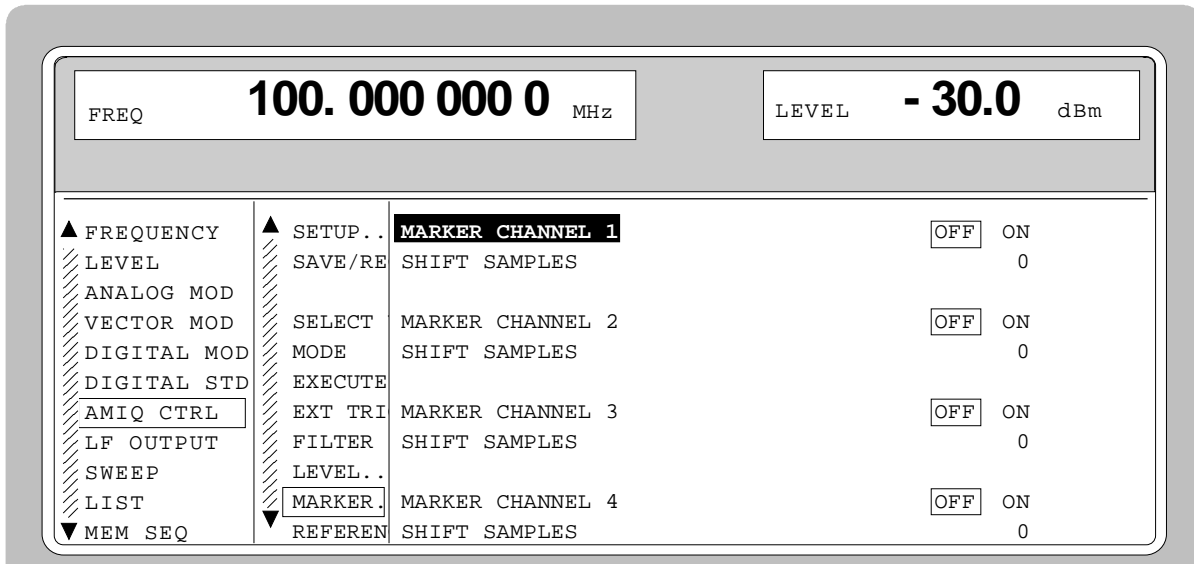

Fig. 2-232 Menu AMIQ CTRL - MARKER...

(MARKER...) **MARKER CHANNEL 1/2/3/4**

Configuration of marker output 1/2/3/4.
 OFF No marker output
 ON Marker output
 SHIFT Marker output displaced by SHIFT SAMPLES.

SHIFT SAMPLES

Number of samples by which the marker of the corresponding marker channel is displaced. Negative values cause the marker sequence to be started earlier while positive values make for a delay of the marker sequence.

REFERENCE OSCILLATOR

Setting the synchronization by a reference clock.
 INT Use of internally generated 10 MHz clock.
 EXT The frequency can be synchronized to an external clock of 10 MHz via the REF input of AMIQ.

Note: *The high-precision 10 MHz clock generated by the internal reference oscillator is always output at the REF output of AMIQ.*

- CLOCK** Sets a clock rate, at which samples can be read out of the output buffer and transferred to the output connectors I and Q via the D/A converters.
Range: 5 MHz to 200 MHz
- CLOCK SOURCE** Selection of the clock signal source (model AMIQ03 or higher).
 INT The internal clock is used. This is the standard setting present upon switching on the unit or changing the clock.
 EXT_SLOW For external clock < 4 MHz
 EXT_FAST For external clock > 2 MHz
- OUTPUT RESOLUTION** Output resolution of the signal. The resolution set for output cannot be higher than for waveform generation.
- BIT ERROR RATE TEST** This menu enables configuration and performance of BER measurement.

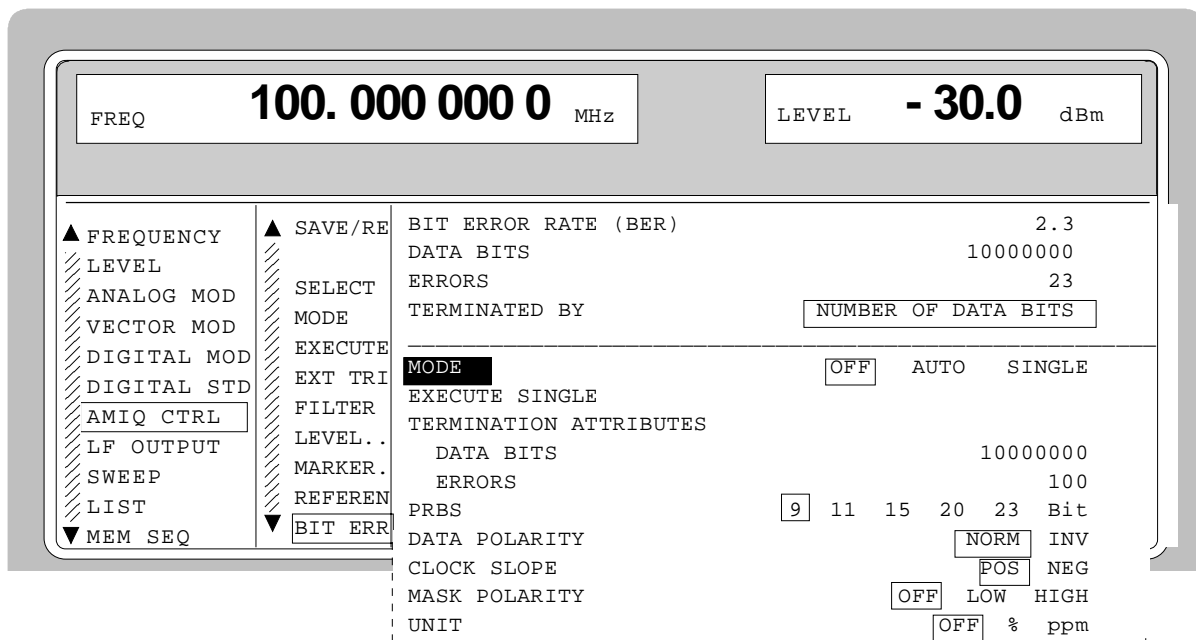

Fig. 2-233 Menu AMIQ CTRL – BIT ERROR RATE TEST...

(BIT ERROR RATE TEST...)	BIT ERROR RATE (BER)	Cyclical indication of the BER measured, ie the ratio of errors occurred to the number of data bits transmitted.
	DATA BITS	Number of data bits transmitted so far.
	ERRORS	Number of errors occurred so far.
	TERMINATED BY	The cause of the indicated measurement result is:
	NUMBER OF DATA BITS	The specified number of data bits has been attained.
	NUMBER OF ERRORS	The specified number of errors has been detected.
	USER	User's manual interruption of the measurement
	----	Measurement in progress

(BIT ERROR RATE TEST...)	STATE	Indication of activities on data and clock line as well as synchronization status.
	MODE	<p>Setting the operating mode for the BER measurement.</p> <p>OFF Terminating measurement.</p> <p>AUTO Continuous BER measurement. If one or both termination criteria are met, a new measurement is initiated. SMIQ cyclically fetches the current measurement results from AMIQ. A measurement can take considerable time, depending on the settings made. During the first measurement, the intermediate results are displayed. For all further measurements, only the final results are shown (by AMIQ). The DATA BITS and ERRORS displayed are continuously updated and indicate the relative values referred to the current measurement.</p> <p>SINGLE Single BER measurement. SMIQ cyclically fetches the current measurement results from AMIQ while the measurement is being performed. If one of the termination criteria is met (TERMINATION ATTRIBUTES - DATA BITS and TERMINATION ATTRIBUTES - ERRORS), the measurement is terminated.</p> <p>A SINGLE measurement can only be initiated by selecting the EXECUTE SINGLE menu.</p>
	EXECUTE SINGLE ►	Initiating a single BER measurement. This menu item is only shown if MODE = SINGLE has been set.
	TERMINATION ATTRIBUTES	<p>DATA BITS Setting the termination criterion „Number of data bits transmitted“</p> <p>ERRORS Setting the termination criterion „Maximum number of errors occurred“</p>
	PRBS	Setting the data period length 9, 11, 15, 20, 23 bits.
	DATA POLARITY	<p>Setting the polarity of the data bits.</p> <p>NORM Normal polarity</p> <p>INV Inverted polarity</p>
	CLOCK SLOPE	<p>Setting the polarity of the clock slopes.</p> <p>POS Rising slope</p> <p>NEG Falling slope</p>
	ENABLE RESTART	Switching on or off the external restart.
	DATA ENABLE	Setting the polarity of the DUT's Data Valid signal. 3 possibilities: NOT_USED, LOW and HIGH.
	UNIT	<p>Setting the unit for indicating the BIT ERROR RATE.</p> <p>OFF Indication without unit, decadic</p> <p>% Indication of relative frequency in per cent</p> <p>ppm Indication of relative frequency in thousandths</p>

2.23 Bit Error Rate Test

Option SMIQB21 allows evaluation of the signal demodulated and decoded by the DUT. For this purpose, a PRBS-modulated data sequence (PRBS = Pseudo Random Binary Sequence) is sent to the DUT. This data sequence can be generated continuously (by means of option SMIQB20) or in sections (option SMIQB60), using a loaded waveform.

The PRBS data sequence is decoded by the DUT and sent to the SMIQ in the form of clock and data signals. The SMIQ synchronizes to the known PRBS sequence and counts the bit errors.

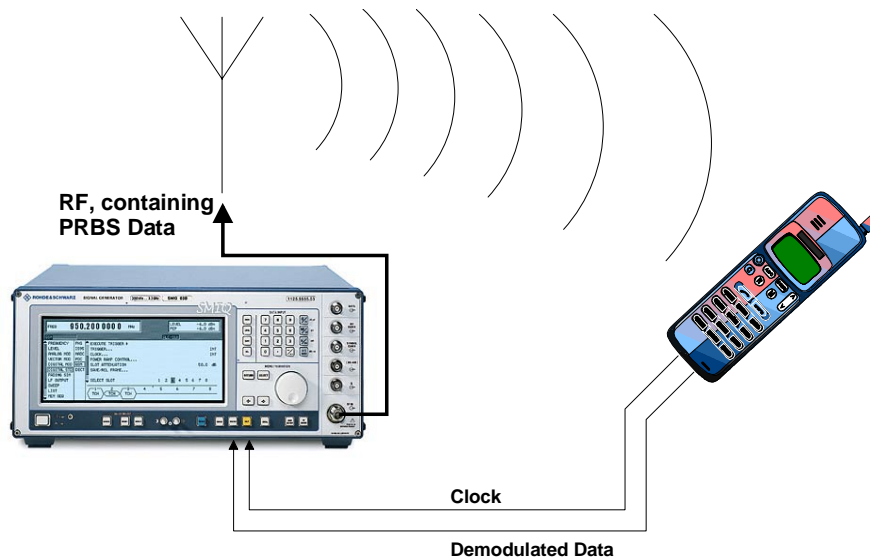

Fig. 2-234 BER Measurement

Termination of a measurement can be induced by various criteria. With option SMIQB21, measurements can be stopped either manually or because of one of the following two criteria: a user-defined number of data bits has been transmitted or a maximum number of errors has been detected.

By means of the RESTART function (eg for IQ signals that are not generated continuously and therefore do not contain integer multiples of PRBS sequences) BER results can be integrated onto the (partial) sequences. In this way, long BER measurements can also be performed on short IQ signals (which normally do not allow BER measurement because the PRBS sequence is not continuous).

The BER measurement can also be performed separately (with data from another source).

In addition to testing PN bit sequences, the option may also be used to verify CRC checksums. This operating mode is described in section 2.23.2.

2.23.1 Bit Error Rate Measurement with PN Sequences (BER)

2.23.1.1 Operating Menu

In the operating menu, the configuration for the BER measurement is made and the results are displayed.

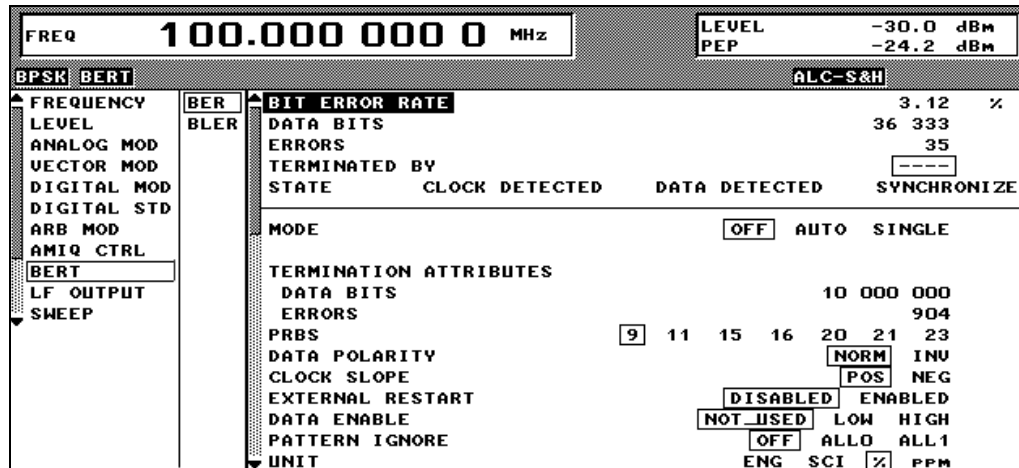

Fig. 2-235 Operating menu for BER measurement

In the upper section of the menu (display area), the measurement results are displayed together with the way in which they have been established, and additional information on the applied signal. In the lower section, settings can be made.

BIT ERROR RATE (BER)	Cyclic display of the measured bit error rate, the ratio of detected errors to transmitted data bits.
DATA BITS	Number of transmitted data bits.
ERRORS	Number of detected errors.
TERMINATED BY	The displayed measurement result was obtained as follows: NUMBER OF DATA BITS The defined number of data bits was reached. NUMBER OF ERRORS The defined number of errors was detected. USER The measurement was interrupted manually by the user. ---- Measurement in progress.

STATE

The status information described in the following tells the user whether the BER measurement is working. The STATE display signals the status of clock line, data line and synchronization. If the clock signal changes, CLOCK is indicated as status, otherwise NO CLOCK. The same applies to the data display DATA or NO DATA. NO DATA may be displayed because DATA ENABLE is not set to NOT USED or the data enable signal does not enable the data. SYNC indicates a successful attempt of PRBS synchronization by the analyzer. It is not before all three of CLOCK, DATA and SYNC are "active" that the measurement results are valid.

CLOCK	Change of clock signal.
NO CLOCK	No change of clock signal.
DATA	Change of data signal.
NO DATA	No change of data signal.
SYNC	Successful synchronization to PRBS.
NO SYNC	No synchronization.

The seven parameters listed above (data bits, error bits, error rate, attribute "terminated", attribute CLOCK, attribute DATA, attribute SYNC) are jointly polled by the IEC/IEEE bus query :BERT:RES? .

MODE

Setting for the BER measurement.

OFF	Terminate measurement.
AUTO	Continuous measurement of bit error rate. If one or both criteria for termination are fulfilled, a new measurement is initiated automatically. Depending on the settings made, a measurement may take considerable time. During the first measurement, intermediate results are displayed. For the measurements that follow, only the final results are shown. The parameters DATA BITS and ERRORS are continuously updated and indicate the relative values for the measurement in progress.
SINGLE	Single measurement of bit error rate. During the measurement, the SMIQ cyclically displays the updated values for rate, number of errors and number of data bits. If any one of the termination criteria (TERMINATION ATTRIBUTES [DATA BITS] and TERMINATION ATTRIBUTES [ERRORS]) is reached, the measurement is stopped. A single measurement is initiated only if the menu item EXECUTE SINGLE is selected.

IEC/IEEE-bus command :BERT:STAT ON
:BERT:SEQ SING

EXECUTE SINGLE➤

Initiates a single BER measurement. This menu item is only displayed if MODE = SINGLE is set.

IEC/IEEE-bus command :TRIG:BERT:IMM

TERMINATION ATTRIBUTES

DATA BITS	Setting the termination criterion "Number of transmitted data bits". IEC/IEEE-bus command :BERT:SET:MCO <1>
ERRORS	Setting the termination criterion "Maximum number of detected errors". IEC/IEEE-bus command :BERT:SET:MERR <1>

PRBS	<p>Setting the period length of data: 9, 11, 15, 16, 20, 21, 23 bits.</p> <p>Note: Data inversion for PRBS15 and PRBS23, which is contained in the standard, is performed automatically when the PRBS is selected. DATA POLARITY remains unaffected.</p> <p>IEC/IEEE-bus command :BERT:SET:TYPE PRBS9</p>
DATA POLARITY	<p>Setting the data bit polarity.</p> <p>NORM Normal polarity</p> <p>INV Inverted polarity</p> <p>IEC/IEEE-bus command :BERT:SET:DATA NORM</p>
CLOCK SLOPE	<p>Setting the clock edge polarity.</p> <p>POS Rising edge</p> <p>NEG Falling edge</p> <p>IEC/IEEE-bus command :BERT:SET:CLOC RIS</p>
EXTERNAL RESTART	<p>Activating/deactivating an external restart of the BER measurement.</p> <p>Note: <i>An enabled RESTART works always independently of PATTERN IGNORE or DATA ENABLE.</i></p> <p>DISABLED Deactivated</p> <p>ENABLED Activated</p> <p>IEC/IEEE-bus command :BERT:SET:REST INT</p>
DATA ENABLE	<p>Setting the polarity of the DUT's DATA ENABLE signal.</p> <p>Note: <i>If the data are not enabled, the execution of the BER measurement is stopped completely. The identification circuit for PATTERN IGNORE as well as the PRBS generator of the BER measurement wait as long as data are not enabled. If the data are enabled, the measurement is continued.</i></p> <p>NOT USED Irrespective of the data enable signal applied, all data at the BERT data input are used for the BER measurement.</p> <p>LOW Only the data applied at the BERT data input with a low-level data enable signal are used for the BER measurement.</p> <p>HIGH Only the data applied at the BERT data input with a high-level data enable signal are used for the BER measurement.</p> <p>IEC/IEEE-bus command :BERT:SET:DEN OFF</p>

PATTERN IGNORE

In the event of a so-called frame error (eg an error detected in the check sum), some mobile radio standards communicate a complete "0" or "1" frame to the BERT instead of the detected frame data. This is to signal to the BERT that this frame is not to be used for the BER measurement.

- OFF PATTERN IGNORE is not active.
- ALL 1 Bit sequences consisting of 31 or more subsequent "1" data are not used (ie ignored) for the BER measurement.
- ALL 0 Bit sequences consisting of 31 or more subsequent "0" data are not used (ie ignored) for the BER measurement.

IEC/IEEE-bus command :BERT:SET:IGN OFF

Notes:

- While ignoring the bits, the PRBS generator for the BER measurement keeps running. Following the "0" or "1" sequence, the BER measurement is continued as if the ignored sequence had contained PRBS data.
- If PATTERN IGNORE is switched on, synchronization time is 32 bits longer.
- If PATTERN IGNORE and RESTART are active at the same time, the presence of the restart signal causes the measurement to stop **immediately**. None of the 32 bits within the PATTERN IGNORE detector is evaluated.
- If DATA ENABLE and PATTERN IGNORE are active at the same time, DATA ENABLE is given priority, ie bits that are not enabled are not examined for "0" or "1" sequences.

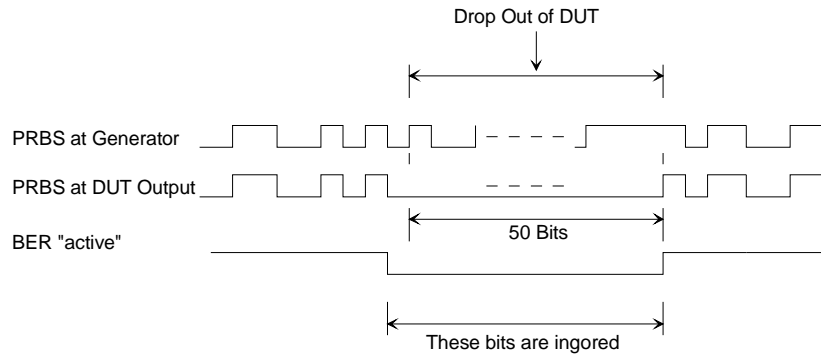

Example 50 bits were set to "0" by the DUT. These 50 bits plus the preceding "0" are ignored in the measurement.

UNIT

Setting the unit for displaying the bit error rate.

- OFF No unit, decade values
- % Relative frequency in percent
- ppm Relative frequency in parts per million

IEC/IEEE-bus command :BERT:UNIT OFF

2.23.1.2 Signal Path and Waveform

See also chapter 1, section "Option SMIQB21", Connector.

Test setup	The signal is computed using one of the modulation sources listed above and then output by the SMIQ and sent to the DUT (device under test). The latter demodulates the source bits contained and returns them to the SMIQ together with a transfer clock. In the SMIQ, the data bits are checked for errors. The total of the transmitted bits and the faulty bits are counted. The quotient of error bits/total bits is the BER.
PRBS data	<p>To be able to detect faulty bits in a BER measurement, the data generation polynomial must be known. Data are calculated with the aid of so-called pseudo-random binary sequences (PRBS). These are quasi-random bit sequences which are repeated according to the selected polynomial.</p> <p>An advantage of the PRBS data is that the bit error detector has only to know the polynomial but not the total sequence. Furthermore, the analysis can be started anywhere in the bit stream, ie the bit-stream source and the analyzer need not be synchronized.</p>
Transfer clock	Should the DUT not provide a transfer clock, the bit clock can be taken from the output connector PAR-DATA for the generation of the signal using option SMIQB11 (DGEN). If AMIQ is used as the IQ source, a marker channel may be programmed as clock output. However, the clock-to-data ratio is to be observed.

2.23.1.3 Test Method

Generation of PRBS data	PRBS data are generated with the aid of a shift register with feedback points determined by the polynomial. A random start status yields one subsequent state. The start status and therefore the subsequent status occur only once in the whole sequence.
Feedback of data stream	<p>If the shift register is filled with a data sequence at the beginning of a measurement and the register is then switched from "filling" to "feedback", the register generates the same data sequence as it expects to receive. Faulty bits can thus be identified and counted by comparing the received data to the results obtained from the shift register.</p> <p>This method has the advantage that the analyzer can be used separately from signal generation (logically and with respect to time). Consequently, delays caused by the DUT, the use of other PRBS sources and transmission over long distances with spatially separated transmitter and receiver, do not cause any problems.</p>
Errors in start status	If a bit error is already present in the start status (faulty bits are not detected during filling), the shift register starts from an incorrect position in the data sequence. As a result all subsequent states will be faulty. Since, statistically, every second bit is faulty, the BER will be about 50%. In this case the measurement is started again automatically, without the user realizing.
<u>BER measurement with uninterrupted repetition of the random sequence</u>	<p>The (non-integrating) BER measurement operates on the basis of random sequences that are run continuously. These sequences are either generated continuously or by cyclic output of a stored sequence, with the number of encoded bits being an integer multiple of the length of the random sequence. The length of the random sequence is 2 to the power of the degree of the polynomial less 1, ie PRBS9 has a length of 511 (2^9 equals 512 less 1).</p> <p>This type of BER measurement is selected by either setting External Restart to DISABLED or by issuing the IEC/IEEE-bus command <code>:BERT:SET:REST INT</code>. The CLOCK and DATA lines are sufficient for this measurement.</p>
The data to be analyzed are interrupted by other data	<p>The data bits contain data like sync, preambles, other channels, etc in addition to the PRBS data. To mark the data to be evaluated, a DAT ENABLE signal has to be sent with the data. Either this DAT ENABLE signal is generated by the DUT or an additional channel of the IQ source is used (eg marker channel of AMIQ).</p> <p>The BER measurement in the SMIQ has to be adjusted for the use of a DAT ENABLE signal; this is done by setting the required polarity in the menu or by means of IEC/IEEE-bus command <code>(:BERT:SET:DEN Low High)</code>. Data Enable = high means that data are only counted by the DUT and subjected to the BER measurement if the data enable input is set to 1.</p>

BER measurement with interrupted random sequence - integrating BER measurement

Due to the type of data, oversampling and the finite memory length of the SMIQ (option SMIQB60) or the AMIQ, it may happen that the generated random sequence is not cyclically repeated at the memory wrap-around but has a break at this point. In a normal BER measurement operating exclusively with CLOCK and DATA signals, a break of this kind would lead to approx. 50% faulty bits due to the loss of synchronization.

A random sequence with a break can be processed by means of the **integrating BER measurement**, it is switched on in the menu under EXTERNAL RESTART (or by the remote-control command `BERT:SETup:REStart EXTErn`). The BER measurement is to be stopped in time and then restarted at the beginning of the data sequence. The measurement is stopped and started via a signal at the RES input (pin 9 of SUB-D connector): A transition from logic 0 to 1 causes a partial result to be generated and the measurement to be stopped. A transition from 1 to 0 starts the measurement for the next sub-interval. This measurement is synchronized anew.

This input is best connected to an AMIQ marker channel or the SMIQ trigger output, with a single 1 encoded both at the start and at the end of the data sequence. This causes the BER measurement to stop briefly at memory wrap-around (the break) and start again. The partial results are integrated.

When the signals are interrupted by other data (eg preambles), these data will normally cause bit errors. The BER measurement for these data can then be interrupted using the data enable input .

In the integrating BER measurement, partial BER results are added up (controlled by a signal at the RES input) until the predefined total number of data or error bits is attained or exceeded.

Note:

Since the test hardware can be programmed flexibly, other bit error measurement techniques such as comparison with the output pattern, masking of certain time and data ranges, are also possible. In this matter, please contact your nearest R&S representative.

PRBS Polynomials

For generating and testing the PRBS, a shift register with feedback is used. The feedback depends on the type of polynomial used. The sequence length of a generator is the result of $2^n - 1$, n being the degree of the polynomial.

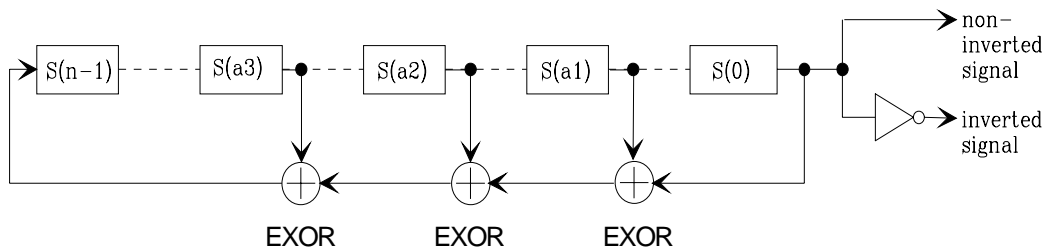

Fig. 2-236 PRBS polynomials

PN generator	N	a1	a2	a3	Output	Acc. to standard
PN9	9	4	-	-	non-inverted	ITU-T Rec. O.153 Fascicle IV.4
PN11	11	2	-	-	non-inverted	ITU-T Rec. O.152 Fascicle IV.4
PN15	15	1	-	-	inverted	ITU-T Rec. O.151 Fascicle IV.4
PN16	16	5	3	2	non-inverted	--
PN20	20	3	-	-	non-inverted	ITU-T Rec. O.153 Fascicle IV.4
PN21	21	2	-	-	non-inverted	--
PN23	23	5	-	-	inverted	ITU-T Rec. O.151 Fascicle IV.4

Measurement Result, Accuracy, Measurement Time

Value range

Measurement results for the bit error rate (ie the quotient of error bits and total bits) are usually found between 10^{-2} and 10^{-9} . This means that a large number of bits may have to be checked before a faulty bit is detected. Because of the large number of bits involved the measurement time is usually very long.

Since 32-bit-wide counters are used for the total bits and the error bits, the maximum measurement time is 4.29×10^9 bits.

Statistics

The BER measurement measures statistical bit errors, ie errors which do not occur at regular intervals but at random. Although a single measurement determines the exact number of errors in the measured interval, a statistically reliable BER can only be obtained when a sufficient number of errors occurs in the observed interval. Only this ensures that the single BER measurement result approaches the true error rate with high probability .

Termination criteria

To keep the measurement time short with low and high bit error rates, two termination criteria have been defined in the SMIQ for the BER measurement.

- Criterion 1: Total number of bits
The measurement is terminated when the specific number of data bits is reached. Due to this criterion the BER measurement is reliably stopped after the specified number of bits even if no error or only a few errors were detected; the measurement result is not statistically reliable (few bit errors).
- Criterion 2: Number of errors
The measurement is terminated when the specified number of bit errors is detected. With this criterion, the measurement is rapidly terminated when high bit error rates occur. Since a great number of errors is counted, the measurement result is statistically reliable.

The two criteria are used together. The criterion which finally yields a valid result is indicated in the results screen ("Measurement terminated by...").

Interruption of measurement

At the end of a measurement, the restart of a new one is delayed until the first measurement result has been queried with `:BERT:RES?`. The resulting brief measurement interruption is irrelevant because the subsequent measurement will be synchronized within 24 data bits.

Possible Problems with BER Measurement and Related Solutions

Fault	Possible cause	Fault description/remedy
BER measurement does not synchronize	No signals received from DUT or the signal level is not correct.	➤ Check displays for activity at BER measurement inputs. If a status is displayed (Clock, Data, Sync) for a line, there is activity.
	The selected PRBS is not correct.	Normally, the PRBS on which the data are based is used as the default setting. If the PRBS is changed, the BER measurement cannot synchronize to the data (because the polynomial is not correct).
	A wrong clock edge is used, which violates setup or hold times.	➤ Check the bit clock signal, the data signal and the data enable signal, if any, on an oscilloscope. The fault may also be caused by reflections on the clock line, which switch the data signal twice into the BER measurement, eg on lines without termination. The SMIQ input is not terminated.
	Incorrect polarity of data signal (or data enable signal).	In this case the PRBS cannot synchronize. Note that an inversion of the output signal specified for some cases by the PRBS standard is performed automatically upon PRBS selection. Manual inversion of the data signal is therefore not required.
	A bit error occurs during synchronization (nine data bits with PRBS9)	The BER measurement is started at a wrong position so that about 50% of the subsequent data bits are identified as faulty.
No clock received from DUT	When testing RF components, clock recovery is not available. An external clock is however required for clocking the data during the BER measurement	Instead of a clock recovery circuit, the bit clock at the PAR-DATA connector of the SMIQ may be possibly used as a replacement. This is possible if DGEN (SMIQB11) is used as a data source. However, this bit clock is not possible with all modulation types. Also, the delay between data and clock has to be observed.
Measured BER too high	The data are clocked with the wrong edge and/or the eye aperture of the data is not optimally met.	➤ Check the clock/data relationship by means of an oscilloscope and set optimum timing.
	BER measurement does not synchronize	If data that are not cyclically continued (ie when a break occurs at the memory wrap-around), the measurement will identify about 50% of the bits as faulty after the wrap-around. Make sure the measurement is started optimally at the beginning of the sequence by means of a signal on the REStart line (see: "BER measurement <u>with interrupted</u> random sequence – integrating BER measurement" in section 2.23.1.3, "Test Method").

2.23.2 Block Error Rate Measurement (BLER)

2.23.2.1 Operating Menu

In the operating menu, the BLER measurement is configured and the results are displayed.

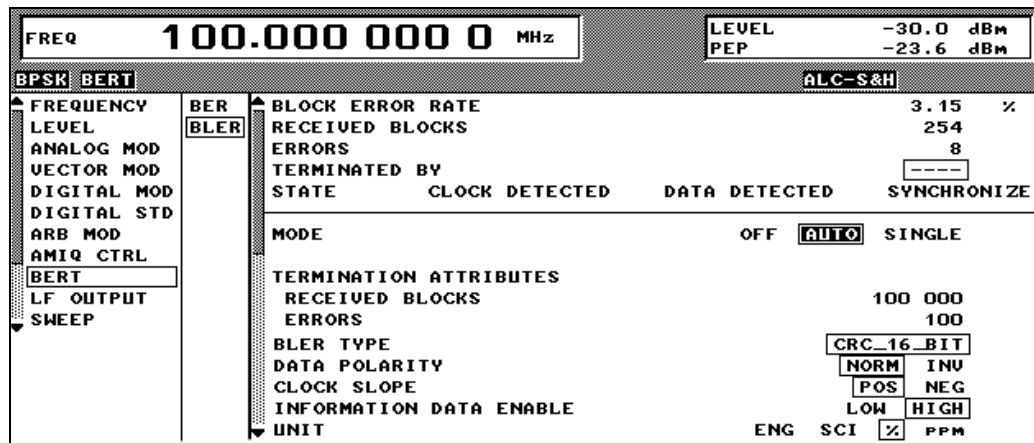

Fig. 2-1 Operating menu for BLER measurement

In the upper section of the menu (display area), the measurement results are displayed, the way in which they have been obtained, and additional information on the applied signal. In the lower section, settings can be made.

BLOCK ERROR RATE (BLER) Cyclic display of measured block error rate, the ratio of detected errors to transmitted data blocks.

RECEIVED BLOCKS IEC/IEEE bus :BLER:RES? Return value 3 (of 7)
Number of transmitted data blocks.

ERRORS IEC/IEEE bus :BLER:RES? Return value 1 (of 7)
Number of detected errors.

TERMINATED BY IEC/IEEE bus :BLER:RES? Return value 2 (of 7)
The displayed measurement result was obtained as follows:
NUMBER OF RECEIVED BLOCKS The defined number of data blocks was reached.
NUMBER OF ERRORS The defined number of errors was detected.
USER The measurement was manually aborted by the user.
---- Measurement in progress.

IEC/IEEE bus :BLER:RES? Return value 4 (of 7)

STATE

The status information described in the following tells the user whether the BLER measurement functions correctly. The STATE display signals the status of clock line, data line and synchronization. If the clock signal changes, CLOCK is indicated as status, otherwise NO CLOCK. The same applies to the DATA or NO DATA display. SYNCHRONIZE indicates a successful attempt of synchronization by the CRC tester. Only when all three displays (CLOCK, DATA and SYNCHRONIZE) are "active" will the measurement results become valid.

CLOCK	Change of clock signal.
NO CLOCK	No change of clock signal.
DATA	Change of data signal.
NO DATA	No change of data signal.
SYNCHRONIZE	Successful synchronization to CRC.
NO SYNC	No synchronization.

The seven parameters listed above (data blocks, error blocks, block error rate, attribute "terminated", attribute CLOCK, attribute DATA, attribute SYNC) are queried together with the IEC/IEEE bus query :BERT:RES? .

MODE

Setting the BLER measurement mode.

OFF	Terminate measurement.
AUTO	Continuous measurements of block error rate. If one or both termination criteria are fulfilled, a new measurement is started automatically. Depending on the settings made, a measurement may take considerable time. During the first measurement, intermediate results are displayed. For all subsequent measurements, only the final results are displayed. The parameters RECEIVED BLOCKS and ERRORS are continuously updated and indicate the relative values for the measurement in progress.
SINGLE	Single measurement of block error rate. During the measurement, the SMIQ cyclically displays the current values for rate, number of errors and data blocks. If any one of the termination criteria (TERMINATION ATTRIBUTES [RECEIVED BLOCKS] and TERMINATION ATTRIBUTES [ERRORS]) is reached, the measurement is terminated. A SINGLE measurement can only be triggered when the menu item EXECUTE SINGLE is selected.

IEC/IEEE-bus command :BLER:STAT ON
:BLER:SEQ SING

EXECUTE TRIGGER

Triggers a single BLER measurement. This menu item is only displayed when MODE = SINGLE is selected.

IEC/IEEE-bus command :TRIG:BLER:IMM

TERMINATION ATTRIBUTES**RECEIVED BLOCKS**

Setting of termination criterion "Number of received data blocks".

IEC/IEEE-bus command :BLER:SET:MCO <1>

ERRORS

Setting of termination criterion "Maximum number of detected errors".

IEC/IEEE-bus command :BLER:SET:MERR <1>

BLER TYPE	Displays the CRC type. Only the CRC_16_BIT type is supported at present. IEC/IEEE-bus command : BLER:SET:TYPE?
DATA POLARITY	Setting the data bit polarity. NORM Normal polarity INV Inverted polarity IEC/IEEE-bus command : BLER:SET:DATA[:POL] NORM
CLOCK SLOPE	Setting the clock edge polarity. POS Rising edge NEG Falling edge IEC/IEEE-bus command : BLER:SET:CLOC[:POL] RIS
INFORMATION DATA ENABLE	Setting the polarity of the DUT's DATA ENABLE signal. LOW The bits received at low level of the data enable signal are interpreted as information bits. The bits received at high level of the data enable signal are interpreted as checksum bits. HIGH The bits received at high level of the data enable signal are interpreted as information bits. The bits received at low level of the data enable signal are interpreted as checksum bits. IEC/IEEE-bus command : BLER:SET:DEN LOW
UNIT	Setting the unit for BLOCK ERROR RATE display. ENG Display in exponential notation, exponent -3 or -6 SCI Display in scientific notation, i.e. normalized to one character ahead of the decimal point % Display of relative frequency in percent ppm Display of relative frequency in parts per million IEC/IEEE-bus command : BLER:UNIT ENG

2.23.2.2 CRC Polynomial

CCITT CRC 16 : $G(x) = x^{16} + x^{12} + x^5 + x^1$ is the only CRC polynomial currently supported. At the beginning of information data (marked by the edge of the DATA ENABLE signal) the shift register is initialized with 0. All information bits are then shifted through the shift register. The CRC component is then read into a second register and compared bit by bit with the result of the calculation.

2.23.2.3 Measurement Result, Accuracy, Measurement Time

Range of values The measurement results for the block error rate (i.e. the quotient of erroneous blocks and total blocks) are normally between 10^{-2} and 10^{-4} . This means that a large number of blocks may have to be tested before an erroneous block occurs. Because of the large number of blocks involved the measurement time is usually very long. Since 32-bit-wide counters are used for the total number of blocks and the error bits, the maximum measurement time is 4.29×10^9 blocks.

Statistics The BLER measurement measures statistical block errors, i.e. errors which do not occur at regular intervals but at random. Although a single measurement determines the exact number of errors in the measured interval, a statistically

reliable BLER can only be obtained when a sufficient number of errors occurs in the observed interval. Only this ensures that the single BLER measurement result approaches the true error rate with high probability.

Termination criteria

To keep the measurement time short for low and high block error rates, two termination criteria have been provided in the SMIQ for the BLER measurement.

- Criterion 1: Total number of blocks
The measurement is terminated when the specified number of data blocks is checked. Due to this criterion the BLER measurement is reliably terminated after the specified number of blocks even if no error or only a few errors were detected; the measurement result may not be statistically reliable (if few block errors occur).
- Criterion 2: Number of errors
The measurement is terminated when the specified number of block errors has occurred. With this criterion, the measurement is rapidly terminated when the block error rate is high. Since a great number of errors has been counted, the measurement result is statistically reliable.

The two criteria are used together. The criterion which finally yields a valid result is displayed under ("Measurement terminated by...").

Interruption of measurement

After termination of a measurement, the restart of a new one is delayed until the first measurement result has been queried with `:BLER:RES?`.

2.23.2.4 Possible BLER Measurement Problems and Solutions

Fault	Possible cause	Fault description/remedy
BLER measurement does not synchronize	No signals received from DUT or the signal level is not correct.	<ul style="list-style-type: none"> ➤ Check activity at BLER measurement inputs in the display. A status display (Clock, Data, Sync) signals activity on the respective line.
	A wrong clock edge is used, which violates setup or hold times.	<ul style="list-style-type: none"> ➤ Check the bit clock signal, the data signal and the DATA ENABLE signal, if any, on an oscilloscope. <p>The fault may also be caused by reflections on the clock line, which clock the data signal twice into the BLER measurement, e.g. if lines are not terminated. The SMIQ input is not terminated.</p>
	Incorrect polarity of data signal (or DATA ENABLE signal).	In this case the CRC tester cannot synchronize.
No clock received from DUT	When testing RF components, clock recovery may not be available. An external clock is however required for clocking the data during the BLER measurement.	The bit clock at the PAR DATA connector of the SMIQ may be used instead of a clock recovery circuit. This is possible if DGEN (SMIQB11) is used as a data source. However, this bit clock is not available with all modulation types. Also, the delay between data and clock has to be taken into account.
Measured BLER too high	The data is switched with the wrong clock edge and/or the eye pattern of the data is not optimally met.	<ul style="list-style-type: none"> ➤ Check the clock/data relationship by means of an oscilloscope and optimize the timing.

2.24 Noise Generator and Distortion Simulator

The noise generator and the distortion simulator (Option SMIQB17) perform the following two functions:

- Addition of noise to the SMIQ output level. Since the C/N can be finely varied, different reception conditions can be realistically simulated.
- Simulation of TWTA (traveling wave tube amplifier) distortion of satellite. The signal received by the satellite is strongly distorted and thus more difficult to demodulate than an undistorted signal. Real reception conditions can be simulated with the distortion simulator and the receivers can thus be tested realistically.

The noise generator outputs an AWGN signal (Additive White Gaussian Noise), ie the noise power ratio is Gaussian-distributed and the noise signal is added to the signal.

Distortion is performed via AM/AM conversion and AM/PM conversion. The respective characteristics can be loaded or modified via IEC/IEEE bus.

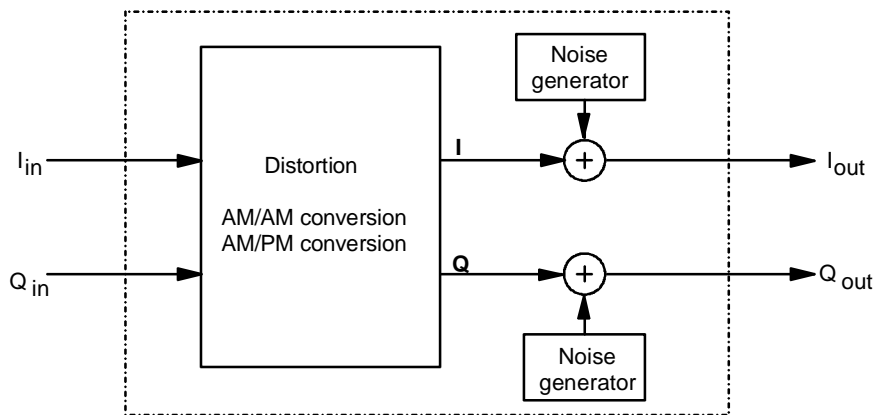

Fig. 2-237 Block diagram of noise generator and distortion simulator

The noise generator and distortion simulator are independent functional units and can be operated separately. They exclusively use baseband signals I and Q. Both external I/Q signals and I/Q signals internally generated by the modulation coder can be distorted and superimposed with noise. The noise generator can also be switched on if internal and external modulation are switched off. The unmodulated carrier is then superimposed with the noise signal.

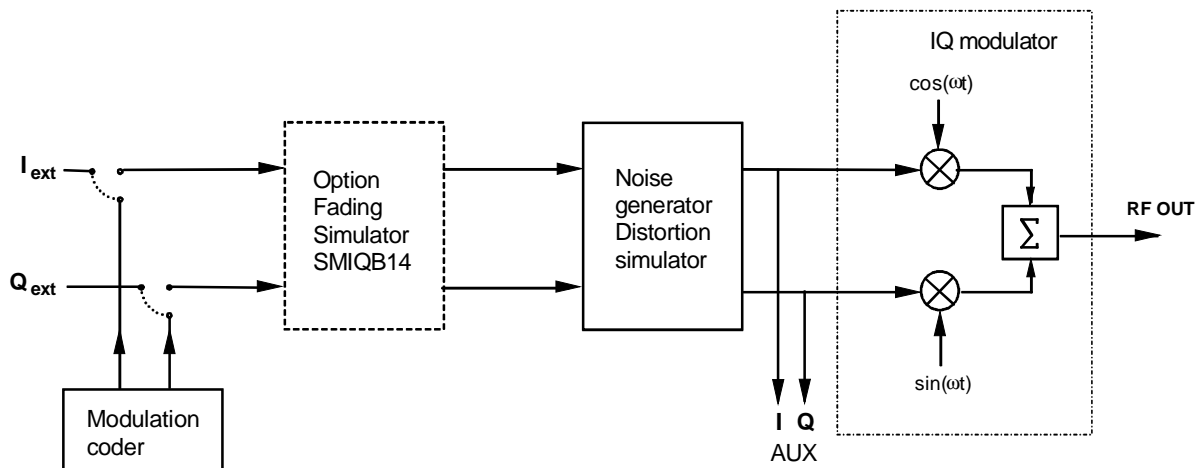

Fig. 2-238 Noise generator and distortion simulator in the SMIQ

2.24.1 Setting NOISE/DIST Menu

The NOISE/DIST menu comprises all the settings of the noise generator and the distortion simulator. For calibration of the noise generator and the distortion simulator, see Chapter 2, Section Calibration VECTOR MOD.

Note: Functions NOISE/DIST and BB-AM cannot be set at the same time and switch off mutually.

Menu selection: NOISE/DIST

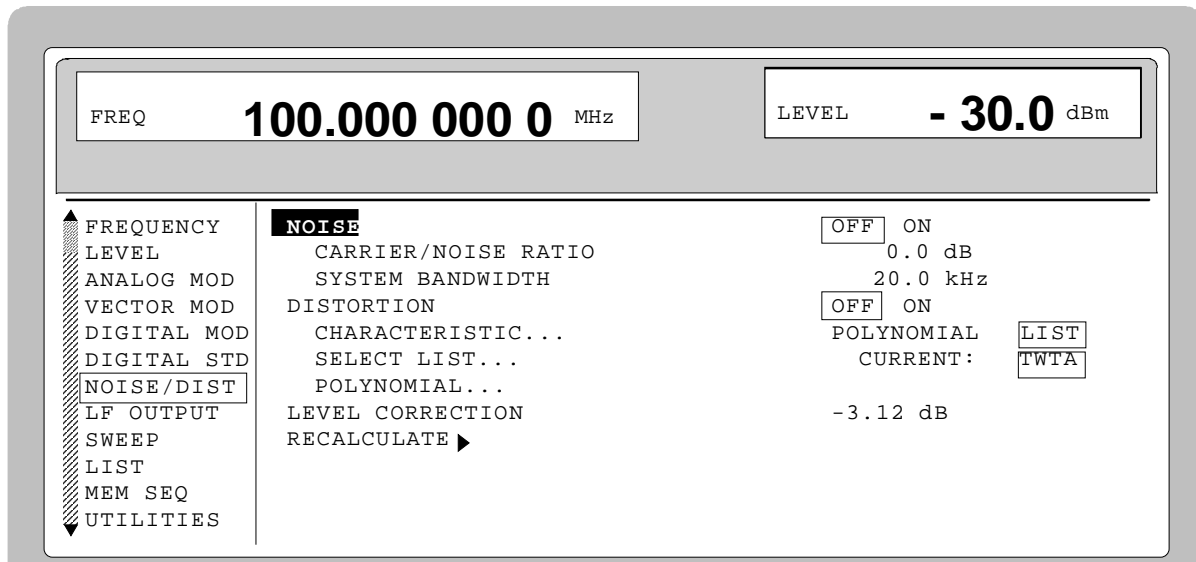

Fig. 2-239 Menu NOISE/DIST (presetting)

NOISE Switch on/off of noise source. The noise source is an AWGN (Additive White Gaussian Noise) signal.

IEC/IEEE-bus commands : SOUR:NOIS ON

CARRIER/NOISE RATIO Input value of the carrier-to-noise ratio. Setting range is 5.0 to 30 dB. When changing the CARRIER/NOISE RATIO, the noise power is changed as well but the carrier power remains unchanged. The carrier power is the power displayed in the header under LEVEL.

IEC/IEEE-bus command : SOUR:NOIS:SNR 10 dB

SYSTEM BANDWIDTH Input value of system bandwidth. The system bandwidth is the HF-bandwidth by which the noise power is calculated. The bandwidth of the generated noise can only be set in steps. The set bandwidth is to be 1.4 times the system bandwidth at minimum and 10 MHz at maximum.

Setting range: 10 kHz to 10 MHz;

Resolution: three digits

IEC/IEEE-bus command : SOUR:NOIS:BAND 1.23 MHz

DISTORTION Switch on/off of distortion.

IEC/IEEE-bus command : SOUR:DIST ON

CHARACTERISTIC... Switchover between distortion data from the polynomial and list. Under polynomial the distortion data are calculated from the coefficients entered into the polynomial menu. Under list they are calculated according to the characteristic transferred via the IEC/IEEE-bus and selected under SELECT LIST.

IEC/IEEE-bus command : SOUR: DIST: MODE POLY | DATA

SELECT LIST... Opens a window for selecting the distortion characteristics. Several distortion characteristics can be stored in the memory at the same time.

IEC/IEEE-bus command : SOUR: DIST: DATA: SEL "TWTA"

POLYNOMIAL... Opens a window for entering the polynomial parameters.

Menu selection: NOISE/DIST - POLYNOMIAL...

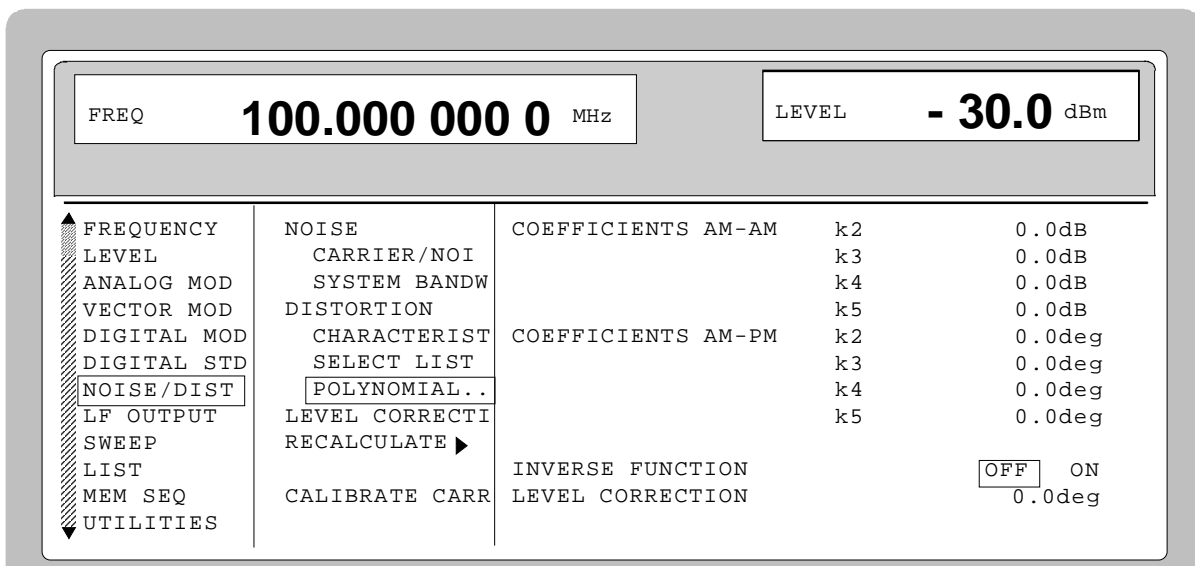

Fig. 2-240 Menu NOISE/DIST - POLYNOMIAL...

(POLYNOMIAL...) **COEFFICIENT AM-AM** Entry of polynomial coefficients k2 to k5 for the AM-AM distortion in dB. The polynomial has the following form:

$$A_{out} = A_{in} + n_2 \cdot A_{in}^2 + n_3 \cdot A_{in}^3 + n_4 \cdot A_{in}^4 + n_5 \cdot A_{in}^5$$
 with $n_{<i>i>} = 10^{(k_{<i>i>}/20)} - 1$, $i = 2, 3, 4, 5$
 Normalization: $A_{out_n} = 0 \dots 1$, $A_{in} = 0 \dots 1$
 The coefficient n0 is always 0 and n1 is always 1.
 Value range: -10.0 to +10.0 dB
 IEEE-bus : SOUR: DIST: POLY: AMAM: K2 -2 DB

COEFFICIENT AM-PM Entry of polynomial coefficients k2 to k5 for the AM-PM distortion in degrees. The polynomial has the following form:

$$P_{out} = P_{in} + k_2 \cdot A_{in}^1 + k_3 \cdot A_{in}^2 + k_4 \cdot A_{in}^3 + k_5 \cdot A_{in}^4$$
 The coefficients K0 and K1 are always 0.
 Value range: - 60.0 to + 60.0 degrees.
 IEEE-bus : SOUR: DIST: POLY: AMPM: K3 -45 DEG

- (POLYNOMIAL...)**
- INVERSE FUNCTION** Compensation of an amplifier connected after the SMIQ, the coefficients entered correspond to the measured distortion of the amplifier.
OFF The above equations are applicable.
ON AM-AM distortion:
inverse function of $A_{out_n}(A_{in})$,
AM-PM distortion:
 $P_{out} = P_{in} - k_2 * A_{out_n}(A_{in})^1 - k_3 * A_{out_n}(A_{in})^2 - k_4 * A_{out_n}(A_{in})^3 - k_5 * A_{out_n}(A_{in})^4$
IEEE-bus : SOUR: DIST: POLY: IFUN ON
- LEVEL CORRECTION** Entry of the level correction for the polynomial. The value entered is active and is displayed in the main menu after selection of the polynomial and calling up RECALCULATE. It can be edited only here.
Value range: -20 dB to +6 dB
IEEE-bus : SOUR: DIST: POLY: LEV: CORR -10 DB
- LEVEL CORRECTION** Display of level correction to correct the output level so that the attenuation or gain of the distortion simulator can be compensated. For the polynomial the level correction can be entered into submenu POLYNOMIAL. The level correction for the lists can only be transferred via the IEC/IEEE bus.
Value range: -20 dB to +6 dB
IEC/IEEE-bus command : SOUR: DIST: DATA: LEV: CORR -3.12 DB
- RECALCULATE ►** Distortion data are active since as they are transferred into the module. This is necessary when the available characteristic has been overwritten via the IEC/IEEE bus or when a polynomial parameter has been modified.
IEC/IEEE-bus command : SOUR: DIST: REC

2.24.2 Loading New Distortion Characteristics

The SMIQ is supplied with a preset distortion characteristic that corresponds to the typical characteristic of a traveling wave tube amplifier in WorldSpace satellites. The name of the characteristic set as standard is TWTA (Traveling Wave Tube Amplifier). Other user-defined distortion characteristics can also be stored in the SMIQ. If several characteristics are stored, they can be selected under SELECT CHARACTERISTIC... .

A new characteristic is formed by the interpolation points of AM/AM and AM/PM conversion. Entry is possible via IEC/IEEE bus. The SMIQ determines the complete characteristic based on these interpolation points by cubic spline interpolation. The factory-set characteristics (TWTA) of AM/AM and AM/PM conversion are shown in the following figures. The continuous line indicates the interpolated characteristic. The circles show the reference points. The input values are on the x-axis, the output values on the y-axis.

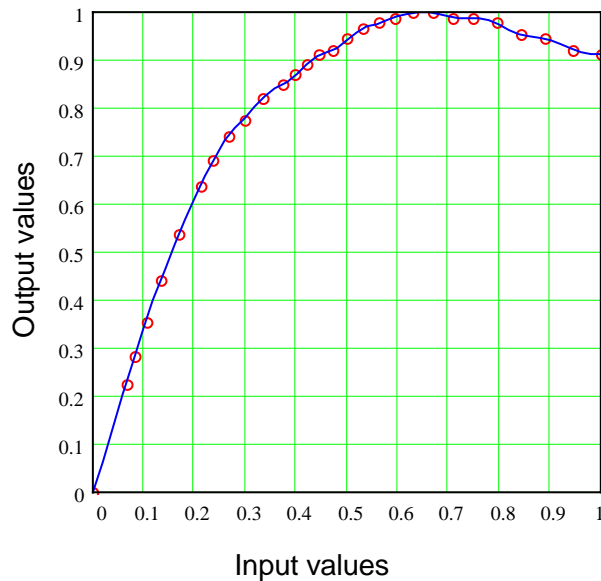

Fig. 2-241 AM/AM conversion

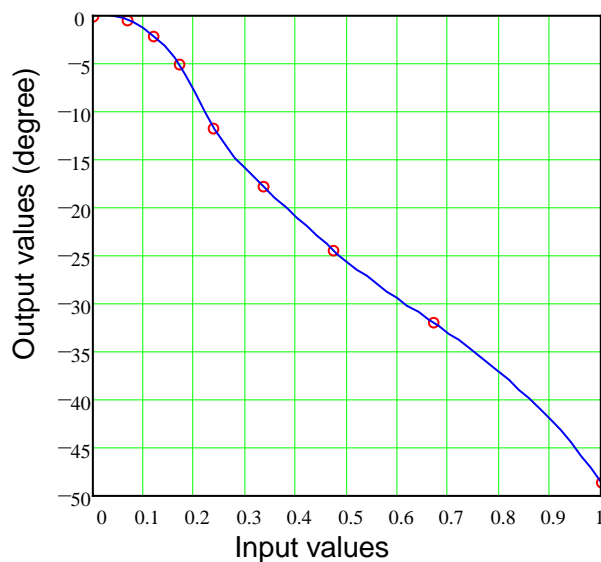

Fig. 2-242 AM/PM conversion

The two characteristics are formed by 2 data fields, the x-axis and the y-axis. 4 data fields therefore have to be loaded for a new distortion characteristic. The minimum number of interpolation points that can be entered for a characteristic is 5, the maximum number is 30. The limit values for the data fields are as follows:

Input values (x-axis) of AM/AM conversion:	-100 dB to 0 dB
Output values (y-axis) of AM/AM conversion:	-100 dB to 0 dB
Input values (x-axis) of AM/PM conversion:	-100 dB to 0 dB
Output values (y axis) of AM/PM conversion:	-180° to +180°

2.24.3 Level Correction of the Distortion Simulator

The level correction influences the level if digital modulation is switched on (not with VECTOR MOD ON) and the distortion simulator is active.

For the rms level set as LEVEL to appear at the RF output, the level control has to compensate for the attenuation or gain of the distortion characteristic. For this purpose, level correction (-20 dB to 6 dB) stored under the previously selected name is transmitted via IEC/IEEE-bus command. If this characteristic is active, the output level is increased or decreased by the level-correction value. The value by which the level is increased or decreased is indicated under LEVEL CORRECTION.

As the attenuation/gain of the distortion characteristic is dependent on the type of input signal being dealt with, the level correction applies only to one particular type of digital modulation (modulation type, filter type and filter parameters) and fading setting.

For the characteristic TWTA, for instance, which is supplied as standard, -3.12 dB is stored as level correction. This value only applies to "WorldSpace Modulation" (QPSK, SQR-COS/0.4).

For the determination of level correction through measurement, the parameter is at first set to 0 dB via IEC/IEEE bus. The desired type of digital modulation is then set, and the characteristic TEST (linear characteristic supplied, LEVEL CORRECTION = 0 dB) activated, followed by the new characteristic. The level difference of the two characteristics is measured at the RF output by means of an RF level meter. The level correction for the new characteristic is then adjusted to the level difference measured via IEC/IEEE bus. If the level difference is measured again, the result should be 0 dB \pm 0.1 dB.

As theoretically the characteristic gain (negative level correction) cannot exceed the crest factor of the modulation used, the warning "Warning 426 Absolute value of level correction > crest factor of Digital Mod;" is displayed if the magnitude of the negative level correction exceeds the crest factor. The correction is also restricted to the crest factor when the level is set, so LEVEL and PEP are identical.

Step-by-step instruction to enter a new distortion characteristic via IEC/IEEE bus:

1. Enter the name of a new characteristic

IEC/IEEE-bus command

```
:SOUR:DIST:DATA:SEL "TWTAl"
```

The characteristic is listed under a freely selectable name (max. 8 characters) in the select menu that comprises different characteristics.

2. Enter the data field for input values (x-axis) of AM/AM conversion in dB

IEC/IEEE-bus command

```
:SOUR:DIST:DATA:AMB -23.5,-21.5,
-19.5,-17.5,-15.5,-13.5,-12.5,-11.5,
-10.5,-9.5,-8.5,-8,-7.5,-7,-6.5,-6,
-5.5,-5,-4.5,-4,-3.5,-3,-2.5,-2,-1.5,
-1,-0.5,0
```

3. Enter the data field for output values (y-axis) of AM/AM conversion in dB

IEC/IEEE-bus command

```
:SOUR:DIST:DATA:AM -12.9,-10.9,-9,
-7.1,-5.4,-3.9,-3.2,-2.6,-2.2,-1.7,
-1.4,-1.2,-1,-0.8,-0.7,-0.5,-0.3,
-0.2,-0.1,0,0,-0.1,-0.1,-0.2,-0.4,
-0.5,-0.7,-0.8
```

4. Enter the data field for input values (x-axis) of AM/PM conversion in dB

IEC/IEEE-bus command

```
:SOUR:DIST:DATA:PMB -23.5,-18.5,
-15.5,-12.5,-9.5,-6.5,-3.5,0
```

5. Enter the data field for output values (y-axis) of AM/PM conversion in degrees

IEC/IEEE-bus command

```
:SOUR:DIST:DATA:PM 0,-2.1,-5,-11.6,
-17.7,-24.4,-31.9,-48.6
```

6. Enter the level correction

IEC/IEEE-bus command

```
:SOUR:DIST:DATA:LEV:CORR -3.12
```

7. Data transmission to the module

IEC/IEEE-bus command

```
:SOUR:DIST:REC
```

Note: The values of the above example correspond to the TWTa characteristic that is supplied.

2.24.4 Calculation of the Distortion Characteristic from Polynomial Equations

A characteristic can be defined by entering polynomial coefficients in submenu POLYNOMIAL instead of transferring reference values via the IEC/IEEE bus. The characteristic is calculated and loaded from the four polynomial coefficients for AM-AM and AM-PM using the equations specified under section 2.24.1. An IEC/IEEE-bus transfer is not required in this case.

It is possible to compensate the distortion of an amplifier connected after the SMIQ using the INVERSE FUNCTION.

The characteristic entered via polynomial coefficients should be identical to the distortion characteristic of the amplifier.

The level correction described in section 2.24.3 can be directly entered in the POLYNOMIAL menu. If the polynomial is activated, this value can be displayed and set in the NOISE/DIST menu under LEVEL CORRECTION. The determination by measurement of the level correction is performed as described in section 2.24.3.

2.25 LF Output

The internal LF generator is available as a signal source for the LF output.

Menu LF OUTPUT offers access to the settings of the LF output.

- Notes:**
- An alteration of the frequency of the internal modulation generator in the LF-output menu automatically effects the modulation for which the generator is selected as modulation source.
 - The SWEEP function of LF generator can be activated in menu SWEEP-LF-GEN.

Menu selection: LF OUTPUT

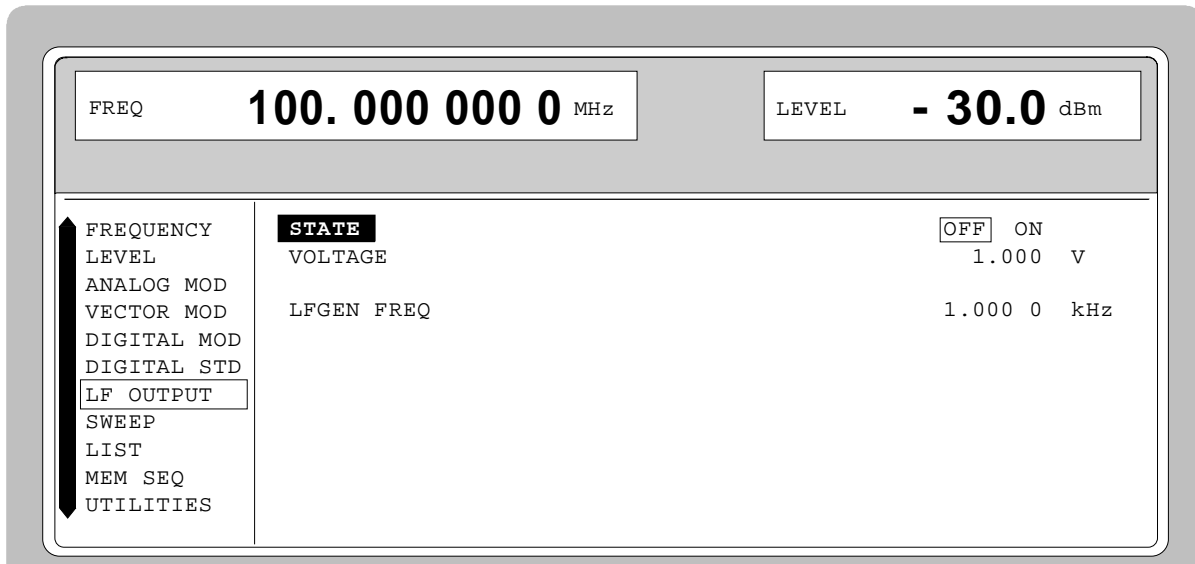

Fig. 2-243 Menu LF OUTPUT (preset setting)

STATE Switching on/off the LF output. Parameter STATE has no influence on the modulation settings.

IEC/IEEE-bus command :OUTP2 ON

VOLTAGE Input value of the output voltage of the LF output. The input is effected in the form of a peak voltage.

IEC/IEEE-bus command :OUTP2:VOLT 1V

LFGEN FREQ Input value of the frequency of internal modulation generator.

IEC/IEEE-bus command :SOUR2:FREQ 1kHz

2.26 Sweep

The SMIQ offers a digital step-by-step sweep for parameters:

- RF frequency
- LF frequency
- RF level

Setting a sweep is effected in five basic steps which are shown in the following example, the setting of a frequency sweep:

1. Set sweep range (START and STOP or CENTER and SPAN).
2. Select linear or logarithmic sequence (SPACING).
3. Set step width (STEP) and dwell time (DWELL).
4. Activate marker if desired (MARKER).
5. Switch on sweep (MODE set to AUTO, SINGLE or STEP).

2.26.1 Setting the Sweep Range (START, STOP, CENTER and SPAN)

The sweep range of the RF sweep can be entered in two different ways. Either by entering the START and STOP value or by entering CENTER and SPAN. Please observe that the two parameter sets influence one another. The influence is exerted in the following way:

START frequency altered:	STOP = unaltered
	CENTER = $(START + STOP)/2$
	SPAN = $(STOP - START)$
STOP frequency altered:	START = unaltered
	CENTER = $(START + STOP)/2$
	SPAN = $(STOP - START)$
CENTER frequency altered	SPAN = unaltered
	START = $(CENTER - SPAN/2)$
	STOP = $(CENTER + SPAN/2)$
	CENTER = unaltered
	START = $(CENTER - SPAN/2)$
	STOP = $(CENTER + SPAN/2)$

2.26.2 Selecting the Sweep Run (SPACING LIN, LOG)

The sweep run, linear or logarithmic, can be selected using SPACING. For the RF and LF sweep, a linear or logarithmic run is possible. For level sweep, only the logarithmic run is possible.

With the logarithmic sweep, step width STEP is equal to a constant fraction of the present setting. The logarithmic step width is entered in unit % with RF or LF sweep, in unit dB with level sweep.

2.26.3 Operating Modes (MODE)

The following sweep operating modes are available:

AUTO Sweep from the starting point to the stop point, with automatic restart at the starting point. If another sweep operating mode was activated prior to the AUTO operating mode, continuation is made from the current sweep setting.

IEC/IEEE-bus commands:

RF sweep:	LF sweep:	Level sweep:
SOUR:FREQ:MODE SWE	SOUR2:FREQ:MODE SWE	SOUR:POW:MODE SWE
SOUR:SWE:MODE AUTO	SOUR2:SWE:MODE AUTO	SOUR:SWE:POW:MODE AUTO
TRIG:SOUR AUTO	TRIG2:SOUR AUTO	TRIG:SOUR AUTO

SINGLE Single run from the starting point to the stop point. If SINGLE is selected, the run is not started yet. Function EXECUTE SINGLE SWEEP ► to be executed, which can be used to start the run, is displayed below the MODE line.

IEC/IEEE-bus commands:

RF sweep:	LF sweep:	Level sweep:
SOUR:FREQ:MODE SWE	SOUR2:FREQ:MODE SWE	SOUR:POW:MODE SWE
SOUR:SWE:MODE AUTO	SOUR2:SWE:MODE AUTO	SOUR:SWE:POW:MODE AUTO
TRIG:SOUR SING	TRIG2:SOUR SING	TRIG:SOUR SING

STEP Step-by-step, manual run within the sweep limits. Activating STEP stops a running sweep and the cursor wraps to the indication value of CURRENT. The sweep run can now be controlled upwards or downwards in discrete steps using the rotary knob or the numeric keys.

IEC/IEEE-bus commands:

RF sweep:	LF sweep:	Level sweep:
SOUR:FREQ:MODE SWE	SOUR2:FREQ:MODE SWE	SOUR:POW:MODE SWE
SOUR:SWE:MODE STEP	SOUR2:SWE:MODE STEP	SOUR:SWE:POW:MODE STEP
TRIG:SOUR SING	TRIG2:SOUR SING	TRIG:SOUR SING

EXT-SINGLE Single run from the starting point to the stop point as in the case of SINGLE, but triggered by an external trigger signal.

IEC-bus short commands:

RF sweep:	LF sweep:	Level sweep:
SOUR:FREQ:MODE SWE	SOUR2:FREQ:MODE SWE	SOUR:POW:MODE SWE
SOUR:SWE:MODE AUTO	SOUR2:SWE:MODE AUTO	SOUR:SWE:POW:MODE AUTO
TRIG:SOUR EXT	TRIG2:SOUR EXT	TRIG:SOUR EXT

EXT-STEP Step-by-step run by means of the external trigger signal. Each trigger event triggers a single step.

IEC-bus short commands:

RF sweep:

SOUR:FREQ:MODE SWE

SOUR:SWE:MODE STEP

TRIG:SOUR EXT

LF sweep:

SOUR2:FREQ:MODE SWE

SOUR2:SWE:MODE STEP

TRIG2:SOUR EXT

Level sweep:

SOUR:POW:MODE SWE

SOUR:SWE:POW:MODE STEP

TRIG:SOUR EXT

OFF The sweep operating mode is switched off.

IEC-bus short commands:

RF sweep:

SOUR:FREQ:MODE CW

LF sweep:

SOUR2:FREQ:MODE CW

Level sweep:

SOUR:POW:MODE CW

2.26.4 Trigger Input

An external signal at the rear input triggers the sweep in the EXT-SINGLE and EXT-STEP operating modes. The polarity of the active trigger edge can be set in menu UTILITIES - AUX I/O EXT TRIG SLOPE .

2.26.5 Sweep Outputs

Outputs X-AXIS, BLANK and MARKER are available at the rear of the instrument to control and trigger oscilloscopes or XY recorders.

X_AXIS With sweep switched on, this output supplies a voltage ramp of 0 to 10 V for the X-deflection of an oscilloscope or an XY recorder.

BLANK This output supplies a signal (0V/5V) to trigger and blank an oscilloscope or for the PEN LIFT control of an XY recorder. The polarity and the period of the signal can be set under UTILITIES - AUX I/O - BLANK POLARITY and - BLANK TIME.

MARKER

This output becomes active when the sweep run has reached the mark. The MARKER signal can be used for the brightness control of an oscilloscope. Up to three marks can be set in order to mark certain positions in the sweep run. The polarity of the signal can be set in menu UTILITIES - AUX I/O - MARKER POLARITY. The period of the active signal is equal to the dwell time (DWELL) of a step.

Signal examples:

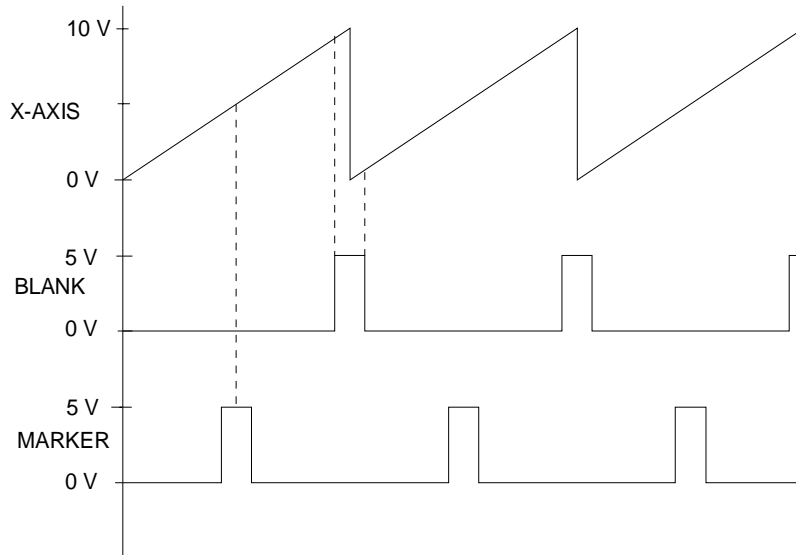

Fig. 2-244 Signal example sweep: MODE = AUTO, BLANK TIME = NORMAL

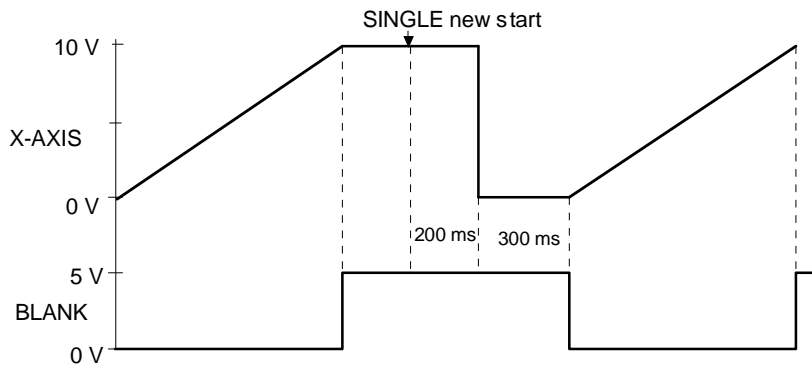

Fig. 2-245 Signal example sweep: MODE = SINGLE, BLANK TIME = LONG

2.26.6 RF Sweep

Menu SWEEP - FREQ offers access to settings for RF sweep.

Menu selection: SWEEP - FREQ

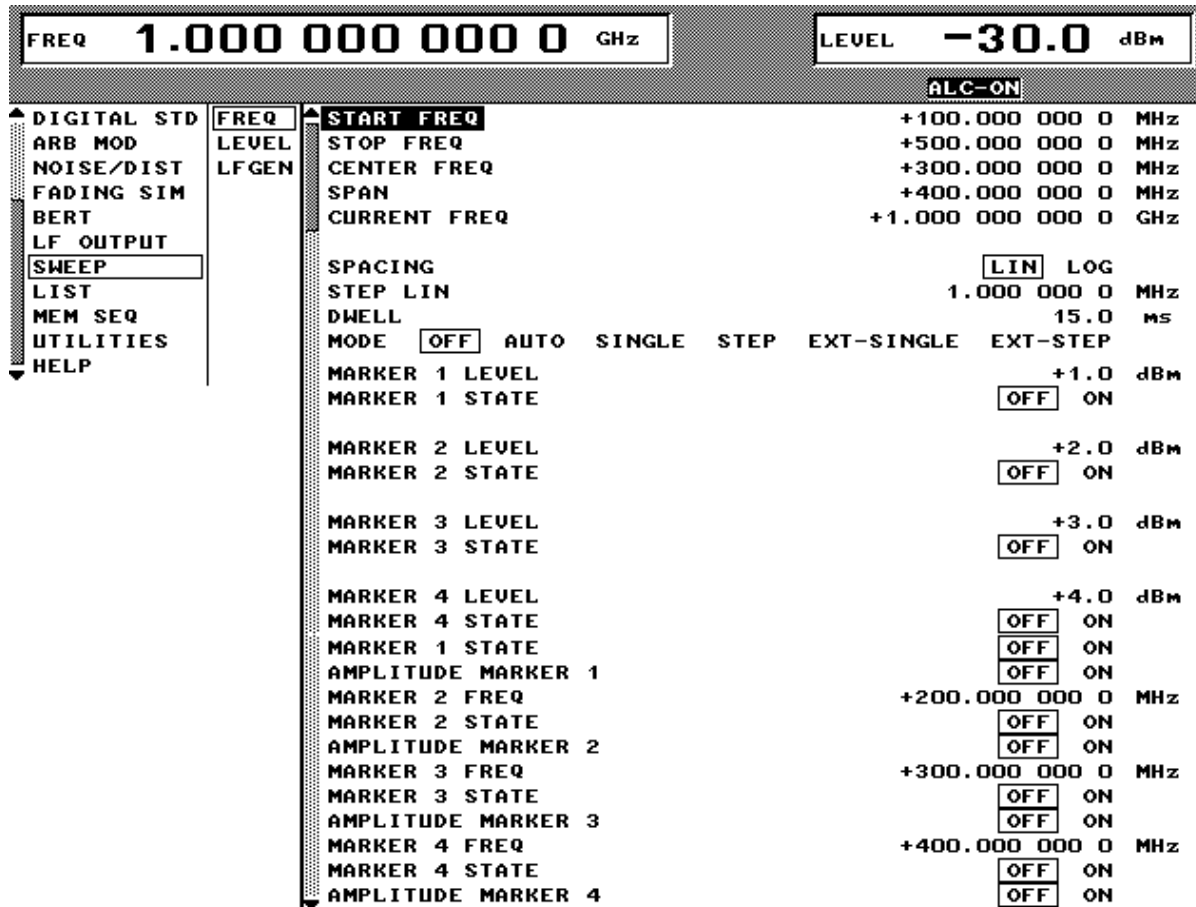

Fig. 2-246 Menu SWEEP - FREQ

START FREQ	Input value of the starting frequency. IEC/IEEE-bus command : SOUR:FREQ:STAR 100MHz
STOP FREQ	Input value of the stop frequency. IEC/IEEE-bus command : SOUR:FREQ:STOP 500MHz
CENTER FREQ	Input value of the center frequency. IEC/IEEE-bus command : SOUR:FREQ:CENT 300MHz
SPAN	Input value of the span. IEC/IEEE-bus command : SOUR:FREQ:SPAN 100MHz
CURRENT FREQ	Indication of the current frequency value. Operating mode STEP: Input value of the frequency.

STEP LIN (LOG)	Input value of the step width. Depending on whether SPACING LIN or LOG is selected, STEP LIN or STEP LOG is displayed. IEC/IEEE-bus command : SOUR:SWE:STEP:LIN 1MHz
DWELL	Input value of the dwell time per step. IEC/IEEE-bus command : SOUR:SWE:DWEL 10ms
SPACING	Input value of the dwell time per step. IEC/IEEE-bus command SOUR:SWE:SPAC LIN
MODE	Selection of the sweep operating mode. IEC/IEEE-bus commands : SOUR:FREQ:MODE SWE ; : SOUR:SWE:MODE AUTO ; : TRIG:SOUR SING
EXECUTE SINGLE SWEEP ►	Starts a single sweep run. This action to be executed is only indicated and is only effective if MODE SINGLE has been selected. IEC/IEEE-bus command : TRIG
RESET SWEEP ►	Sets the starting frequency. IEC/IEEE-bus command : ABOR
MARKER 1 FREQ MARKER 2 FREQ MARKER 3 FREQ MARKER 4 FREQ	Input value of the frequency for the marker selected IEC/IEEE-bus command : SOUR:MARK1:FREQ 100MHz
MARKER 1 STATE MARKER 2 STATE MARKER 3 STATE MARKER 4 STATE	Switching on/off the marker selected IEC/IEEE-bus command : SOUR:MARK1 OFF
AMPLITUDE MARKER1 AMPLITUDE MARKER 2 AMPLITUDE MARKER 3 AMPLITUDE MARKER 4	Switching on/off the amplitude marker selected OFF Input value of the frequency for the marker selected ON Amplitude marker is switched on. On reaching the mark the output level is reduced by 1 dB. IEC/IEEE-bus command : SOUR:MARK1:AMPL OFF

2.26.7 LEVEL Sweep

Menu SWEEP - LEVEL offers access to settings for LEVEL sweep.

Menu selection: SWEEP - LEVEL

FREQ 1.000 000 000 0 GHz		LEVEL -30.0 dBm	
		ALC-ON	
▲ DIGITAL STD ARB MOD NOISE/DIST FADING SIM BERT LF OUTPUT SWEEP LIST MEM SEQ UTILITIES ▼ HELP	FREQ	▲ START LEVEL	-30.0 dBm
	LEVEL	STOP LEVEL	-10.0 dBm
	LFGEN	CURRENT LEVEL	-30.0 dBm
		STEP	1.0 dB
		DWELL	15.0 ms
		MODE	<input type="checkbox"/> OFF <input type="checkbox"/> AUTO <input type="checkbox"/> SINGLE <input type="checkbox"/> STEP <input type="checkbox"/> EXT-SINGLE <input type="checkbox"/> EXT-STEP
		RESET SWEEP ▶	
		MARKER 1 LEVEL	+1.0 dBm
		MARKER 1 STATE	<input type="checkbox"/> OFF <input type="checkbox"/> ON
		MARKER 2 LEVEL	+2.0 dBm
		MARKER 2 STATE	<input type="checkbox"/> OFF <input type="checkbox"/> ON
		MARKER 3 LEVEL	+3.0 dBm
		MARKER 3 STATE	<input type="checkbox"/> OFF <input type="checkbox"/> ON
		MARKER 4 LEVEL	+4.0 dBm
		MARKER 4 STATE	<input type="checkbox"/> OFF <input type="checkbox"/> ON

Fig. 2-247 Menu SWEEP - LEVEL

START LEVEL	Input value of the starting level. IEC/IEEE-bus command : POW:STAR -30dBm
STOP LEVEL	Input value of the stop level. IEC/IEEE-bus command : SOUR:POW:STOP -10dBm
CURRENT LEVEL	Indication of the current level. Operating mode STEP: Input value of the level.
STEP	Input value of the step width. IEC/IEEE-bus command : SOUR:SWE:POW:STEP 1dB
DWELL	Input value of the dwell time per step IEC/IEEE-bus command : SOUR:SWE:POW:DWEL 15ms
MODE	Selection of the sweep operating mode. IEC/IEEE-bus commands : SOUR:POW:MODE SWE ; : SOUR:SWE:POW:MODE AUTO ; : TRIG:SOUR SING
EXECUTE SINGLE SWEEP ▶	Starts a single sweep run. This action to be executed is only indicated and is only effective if MODE SINGLE is selected. IEC/IEEE-bus command : TRIG

- RESET SWEEP ► Sets the starting level.
IEC/IEEE-bus command : ABOR

- MARKER 1 LEVEL Input value of the level for the marker selected.
IEC/IEEE-bus command : SOUR:MARK1:PSW:POW 0dBm
- MARKER 2 LEVEL
- MARKER 3 LEVEL
- MARKER 4 LEVEL

- MARKER 1 STATE Switching on/off the marker selected.
IEC/IEEE-bus command : SOUR:MARK1:PSW OFF
- MARKER 2 STATE
- MARKER 3 STATE
- MARKER 4 STATE

2.26.8 LF Sweep

Menu SWEEP - LF GEN offers access to settings for LF sweep.

Menu selection: SWEEP - LF GEN

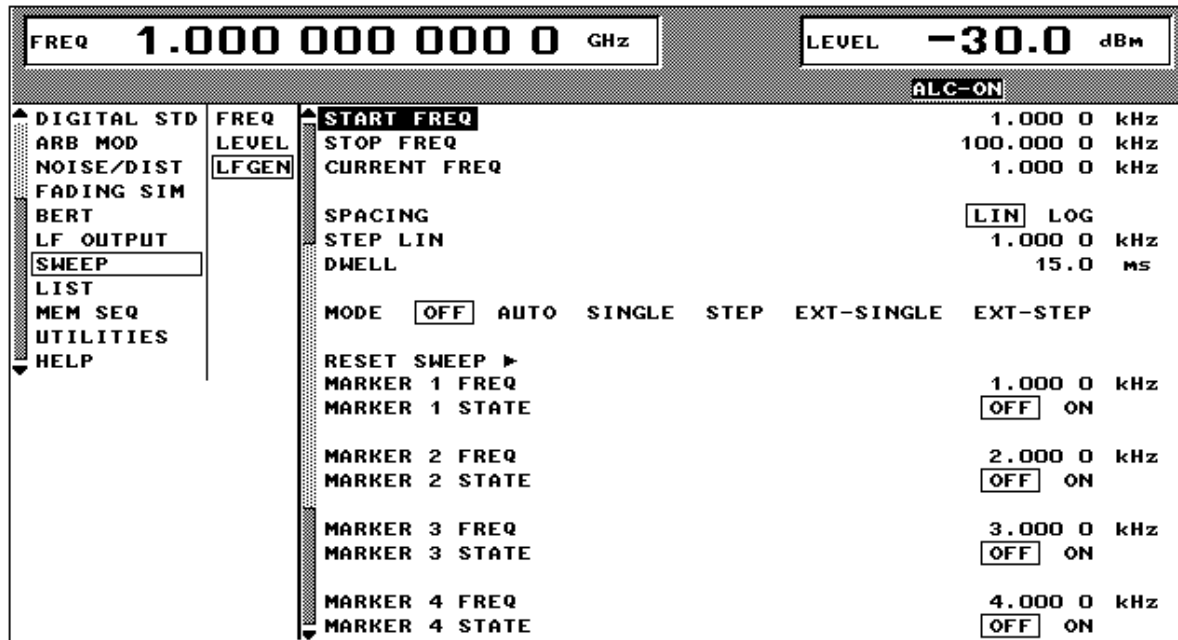

Fig. 2-248 Menu SWEEP - LF GEN

START FREQ	Input value of the starting frequency. IEC/IEEE-bus command : SOUR2:FREQ:STAR 100kHz
STOP FREQ	Input value of the stop frequency. IEC/IEEE-bus command : SOUR2:FREQ:STOP 50kHz
CURRENT FREQ	Indication of the current frequency value. Operating mode STEP: Input value of the frequency.
STEP	Input value of the step width. IEC/IEEE-bus command : SOUR2:SWE:STEP:LIN 1kHz
DWELL	Input value of the dwell time per step. IEC/IEEE-bus command : SOUR2:SWE:DWEL 15ms
SPACING	Selection of the sweep run, linear or logarithmic. IEC/IEEE-bus command : SOUR2:SWE:SPAC LIN
MODE	Selection of the sweep operating mode. IEC/IEEE-bus command : SOUR2:FREQ:MODE SWE : SOUR2:SWE:MODE AUTO : TRIG2:SOUR SING
EXECUTE SINGLE SWEEP ►	Starts a single sweep run. This action to be executed is only indicated and is only effective if MODE SINGLE is selected. IEC/IEEE-bus command : TRIG
RESET SWEEP ►	Sets the starting frequency. IEC/IEEE-bus command : ABOR
MARKER 1 FREQ MARKER 2 FREQ MARKER 3 FREQ MARKER 4 FREQ	Input value of the frequency for the marker selected. IEC/IEEE-bus command : SOUR2:MARK1:FREQ 1kHz
MARKER 1 STATE MARKER 2 STATE MARKER 3 STATE MARKER 4 STATE	Switching on/off the marker selected. IEC/IEEE-bus command : SOUR2:MARK1 OFF

2.27 LIST Mode

A sequence of predefined frequency and level points is executed in the LIST mode, similar as in a sweep. Differently from the sweep, however, a list with freely selectable pairs of values (frequency and level) can be generated. The specified range of the frequency comprises the entire adjustable frequency range of the instrument. The specified range of the level covers a 20-dB range. If the permissible variation range is exceeded, the level error increases.

Caution: After the generation or change of a list in the LIST mode, function LEARN has to be started to ensure that the new settings are transferred to the hardware (IEC-bus short command: `LIST:LEAR`).

Table 2-33 LIST mode; Example of a list

Index	Frequency	Level
0001	100 MHz	0 dBm
0002	575 MHz	13 dBm
0003	235 MHz	7 dBm
0100	333 MHz	5 dBm
:	:	:

Up to 10 lists can be created. The total amount of possible pairs of values including all lists may maximally be 2000. I.e., a list may have 2000 entries at the most, or less if several lists have been created.

Each list is identified by a separate name and selected via this name. A detailed description how to process the lists can be found in Section 2.2.11, List Editor.

2.27.1 Operating Modes (MODE)

The following LIST-operating modes are available:

AUTO Run from the beginning to the end of the list with automatic restart at the beginning. If another mode was activated prior to the AUTO operating mode, continuation is made from the current index.

IEC/IEEE-bus commands: `:SOUR:FREQ:MODE LIST`
`:SOUR:LIST:MODE AUTO`
`:TRIG:LIST:SOUR AUTO`

SINGLE Single run from the beginning to the end of the list. If SINGLE is selected, the run is not yet started. Function EXECUTE SINGLE LIST ► to be executed, which can be used to start the run, is displayed below the MODE line.

IEC/IEEE-bus commands: `:SOUR:FREQ:MODE LIST`
`:SOUR:LIST:MODE AUTO`
`:TRIG:LIST:SOUR SING`

STEP	<p>Step-by-step manual processing of the list. Activating STEP stops a list running and the cursor wraps to the indication value of CURRENT INDEX. The list can now be controlled upwards or downwards in discrete steps using the rotary knob or the numeric keys.</p> <p>IEC/IEEE-bus commands: : SOUR:FREQ:MODE LIST : SOUR:LIST:MODE STEP : TRIG:LIST:SOUR SING</p>
EXT-SINGLE	<p>Single run from the beginning to the end of the list as with SINGLE, but triggered by an external trigger signal.</p> <p>IEC/IEEE-bus commands: : SOUR:FREQ:MODE LIST; : SOUR:LIST:MODE AUTO : TRIG:LIST:SOUR EXT</p>
EXT-STEP	<p>Step-by-step run by means of the external trigger signal. Each trigger event triggers a single step.</p> <p>IEC/IEEE-bus commands: : SOUR:FREQ:MODE LIST : SOUR:LIST:MODE STEP : TRIG:LIST:SOUR EXT</p>
HOP	<p>Step-by-step run by means of the internal trigger signal of the data generator (see also Section 'Internal Modulation Data and Control Signals from Lists' and Section 'Menu DIGITAL STANDARD - GSM'). Each trigger event triggers a single step.</p> <p>IEC/IEEE-bus commands: : SOUR:FREQ:MODE LIST : SOUR:LIST:MODE STEP : TRIG:LIST:SOUR HOP</p>
OFF	<p>Operating mode LIST is switched off.</p> <p>IEC/IEEE-bus command: : SOUR:FREQ:MODE CW</p>

Note: *The minimum step time of 1 ms must not be violated in modes EXT-STEP and HOP either. With fading switched on, the minimum step time is increased to 3 ms, in case of Lognormal fading it is increased to 50 ms.*

2.27.2 Inputs/Outputs

TRIGGER input and BLANK output are available at the rear of the instrument for synchronization with other instruments.

TRIGGER An external signal at this input triggers the LIST mode in operating modes EXT-SINGLE and EXT-STEP. The polarity of the active trigger edge can be set in the UTILITIES - AUX I/O - EXT TRIG SLOPE menu.

BLANK This output supplies a signal (0 V/5 V) to blank the settling process by means of pulse modulation or AM. The signal can also be used to synchronize other instruments. The polarity of the signal can be set in the UTILITIES - AUX I/O - BLANK POLARITY menu.

MARKER

At the first step of the LIST mode, this output provides an approx. 200 μ s trigger signal immediately after blanking. At small DWELL times, this signal can be used for an accurate synchronization to trigger other devices and shows the first stable output frequency. The delay to the fed-in signal at the TRIGGER input for EXT-SINGLE or EXT-STEP is 1.5 to 2 ms and has a jitter of 0.5 ms.

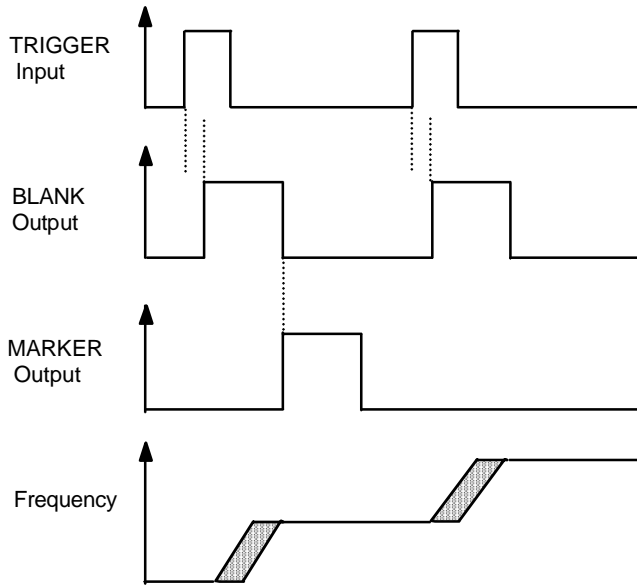

Fig. 2-249 Signal example LIST mode: MODE = EXT-STEP

The LIST menu offers access to settings for the LIST mode.

Menu selection: LIST

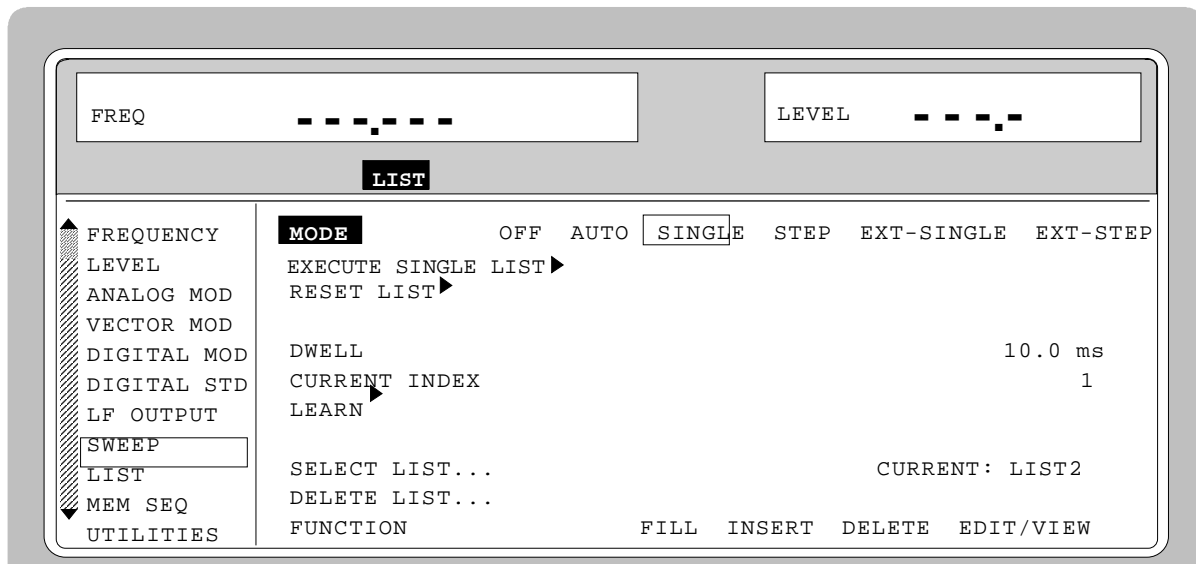

Fig. 2-250 Menu LIST - OPERATION page

MODE	<p>Selection of the operating mode.</p> <p>IEC/IEEE-bus commands : :SOUR:FREQ:MODE LIST; :SOUR:LIST:MODE AUTO; :TRIG:LIST:SOUR SING</p>
EXECUTE SINGLE LIST ►	<p>Starts a single run of a list. This menu option is only visible if MODE SINGLE is selected.</p> <p>IEC/IEEE-bus command : :TRIG:LIST</p>
RESET LIST ►	<p>Sets the starting point.</p> <p>IEC/IEEE-bus command : :ABOR:LIST</p>
DWELL	<p>Input value of the dwell time per step.</p> <p>IEC/IEEE-bus command : :SOUR:LIST:DWEL 10ms</p>
CURRENT INDEX	<p>Indication of the current list index. Setting value of the current list index in the STEP operating mode.</p>
LEARN ►	<p>Starts the LEARN function. All value pairs of the active list are subsequently set by the instrument with the current additional parameters, and the hardware setting data are stored.</p> <p>Caution: <i>This function must be called after every creating and altering the list (or the remaining setting data). The list must be learned as well after temperature changes or after calling internal calibration routines, as all parameters usually controlled are replaced by stored values in the LIST mode.</i></p> <p>IEC/IEEE-bus command : :SOUR:LIST:LEAR</p>
SELECT LIST...	<p>Selection of a list or creation of a new list (cf. Section 2.2.11, List Editor).</p> <p>IEC/IEEE-bus command : :SOUR:LIST:SEL 'LIST2'</p>
DELETE LIST...	<p>Deletion of a list (cf. Section 2.2.11, List Editor).</p> <p>IEC/IEEE-bus command : :SOUR:LIST:DEL 'LIST1'</p>
FUNCTION	<p>Selection of the editor functions to process a list (cf. Section 2.2.11, List Editor).</p> <p>IEC/IEEE :SOUR:LIST:FREQ 100MHz, 1.2GHz; POW 0dBm, 6dBm</p>

The second page of the LIST menu, the EDIT page is automatically activated if one of the editor functions of line FUNCTION is selected. The list which is displayed as CURRENT LIST in the SELECT LIST line is shown.

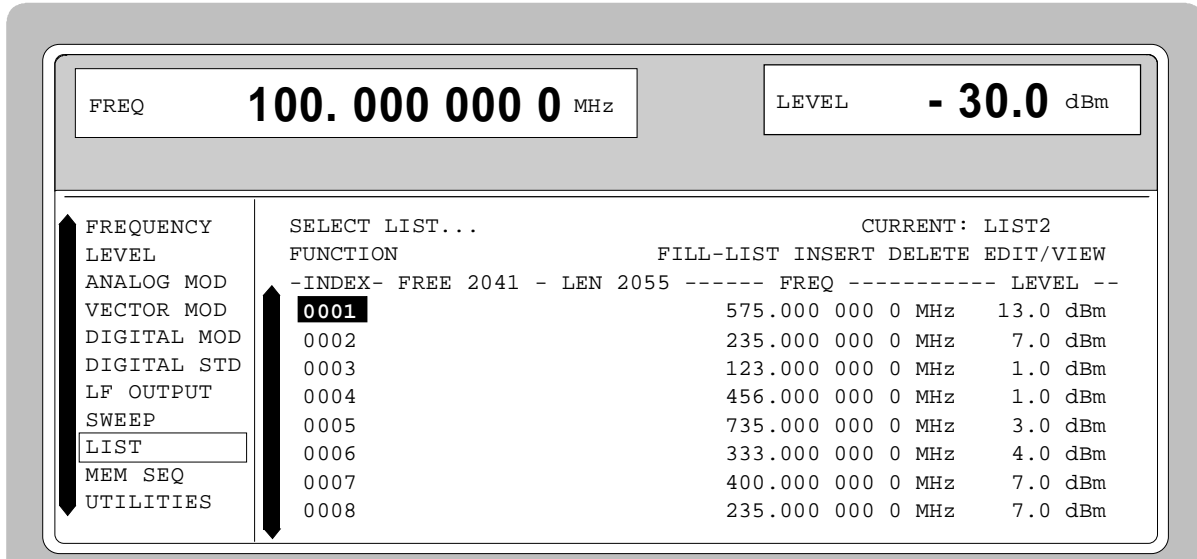

Fig. 2-251 Menu List - EDIT page

- INDEX** Index of the list.
- FREE** Indication of the list entries still vacant.
- LENGTH** Length of the current list.
- FREQ** Parameter: Frequency.
- LEVEL** Parameter: Level; specified range 20 dB.

2.28 Memory Sequence

In the memory-sequence operating mode the instrument automatically services a list with stored instrument settings. Memory locations 1 to 50, which are loaded using SAVE and whose stored settings are called either separately using RECALL or automatically and subsequently in the SEQUENCE mode, are available.

The list is continuously serviced from the beginning to the end with a continual index. The order of the memories to be passed through is arbitrary. Each setting can be assigned a freely selectable dwell time. The dwell time determines the duration of the setting, its minimal value is 50 ms, its maximal value 60 sec.

The list is divided up into 3 columns for list index, memory location number (Memory) and dwell time (Dwell). The beginning of the list has index 1.

Table 2-35 MEMORY SEQUENCE; Example of a list

Index	Memory	Dwell
001	09	50.0 ms
002	02	50.0 ms
003	01	75.0 ms
004	10	75.0 ms
...

Up to 10 sequence lists can be created. The total number of possible list elements is maximally 256. I.e., a list can have 256 entries at the most, or less if several lists have been created.

Each list is identified by a separate name and selected via this name. A detailed description how to process the lists can be found in Section 2.2.4, List Editor.

Note: *Frequently changing the level in the operating mode MEMORY SEQUENCE can stress the mechanically switched attenuator. The attenuator is also actuated when AM is switched on or off. For this reason we recommend that you make use of the non-interrupting level setting as much as possible and that you use the setting AM 0% instead of switching AM off.*

Operating Modes (MODE)

The following operating modes are available:

- AUTO** Run from the beginning to the end of the list with automatic restart at the beginning. If another mode was activated prior to the AUTO operating mode, continuation is made from the current index.
- IEC/IEEE-bus command: :SYST:MODE MSEQ;
 :SYST:MSEQ:MODE AUTO
 :TRIG:MSEQ:SOUR AUTO
- SINGLE** Single run from the beginning to the end of the list. If SINGLE is selected, the run is not yet started. Below the MODE line, function EXECUTE SINGLE SEQUENCE ► to be executed is displayed which can be used to start the run.
- IEC/IEEE-bus command :SYST:MODE MSEQ;
 :SYST:MSEQ:MODE AUTO
 :TRIG:MSEQ:SOUR SING
- STEP** Step-by-step manual processing of the list. Activating STEP stops an automatic run and the cursor wraps to the indication value of CURRENT INDEX. The list can now be passed through upwards or downwards step by step using the rotary knob.
- IEC/IEEE-bus command :SYST:MODE MSEQ;
 :SYST:MSEQ:MODE STEP
 :TRIG:MSEQ:SOUR SING
- EXT-SINGLE** Single run from the beginning to the end of the list as with SINGLE, but triggered by an external trigger signal.
- IEC/IEEE-bus command :SYST:MODE MSEQ;
 :SYST:MSEQ:MODE AUTO
 :TRIG:MSEQ:SOUR EXT
- EXT-STEP** Step-by-step run using the external trigger signal. Each trigger event triggers a single step.
- IEC/IEEE-bus command :SYST:MODE MSEQ;
 :SYST:MSEQ:MODE STEP
 :TRIG:MSEQ:SOUR EXT
- OFF** Step-by-step run using the external trigger signal. Each trigger event triggers a single step.
- IEC/IEEE-bus command :SYST:MODE FIX

External Trigger

An external signal at the rear input TRIGGER triggers the MEMORY SEQUENCE in the EXT-SINGLE and EXT-STEP operating modes. The polarity of the active trigger edge can be set in the UTILITIES - AUX I/O - EXT TRIG SLOPE menu.

Menu MEM SEQ with the two menu pages OPERATION and EDIT offers access to the memory-sequence operating mode.

Menu selection: MEM SEQ

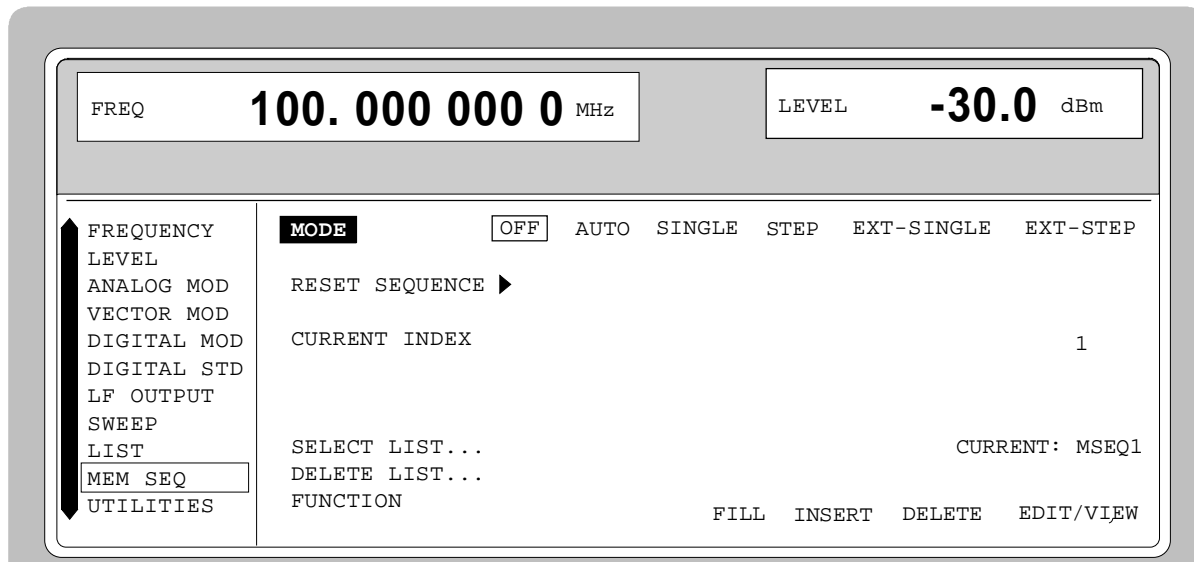

Fig. 2-252 Menu MEM SEQ -OPERATION- page (preset setting)

MODE	Selection of the operating mode; setting the operating mode regards various command systems at the IEC bus (cf. above).
EXECUTE SINGLE SEQUENCE ►	Starts the single run of a memory sequence. This menu option is only visible if MODE SINGLE is selected. IEC/IEEE-bus command :TRIG:MSEQ
RESET SEQUENCE ►	Wrap to the beginning of the list. IEC/IEEE-bus command :ABOR:MSEQ
CURRENT INDEX	Indication of the current list index. Setting value of the current list index in the MODE STEP operating mode.
SELECT LIST...	Selection of a list or generation of a new list (cf. Section 2.2.4, List Editor). IEC/IEEE-bus command :SYST:MSEQ:SEL "MSEQ1"
DELETE LIST...	Deletion of a list (cf. Section 2.2.4, List Editor). IEC/IEEE-bus command :SYST:MSEQ:DEL "MSEQ2"
FUNCTION	Selection of the editor functions to process a list (cf. Section 2.2.4, List Editor). IEC/IEEE-bus command :SYST:MSEQ 9,2,...; :SYST:MSEQ:DWEL 50ms, 50ms,.

The second page of menu MEM SEQ, the EDIT page, is automatically activated if one of the editor functions of the FUNCTION line is selected. The list which is entered as CURRENT LIST in the SELECT LIST line is shown.

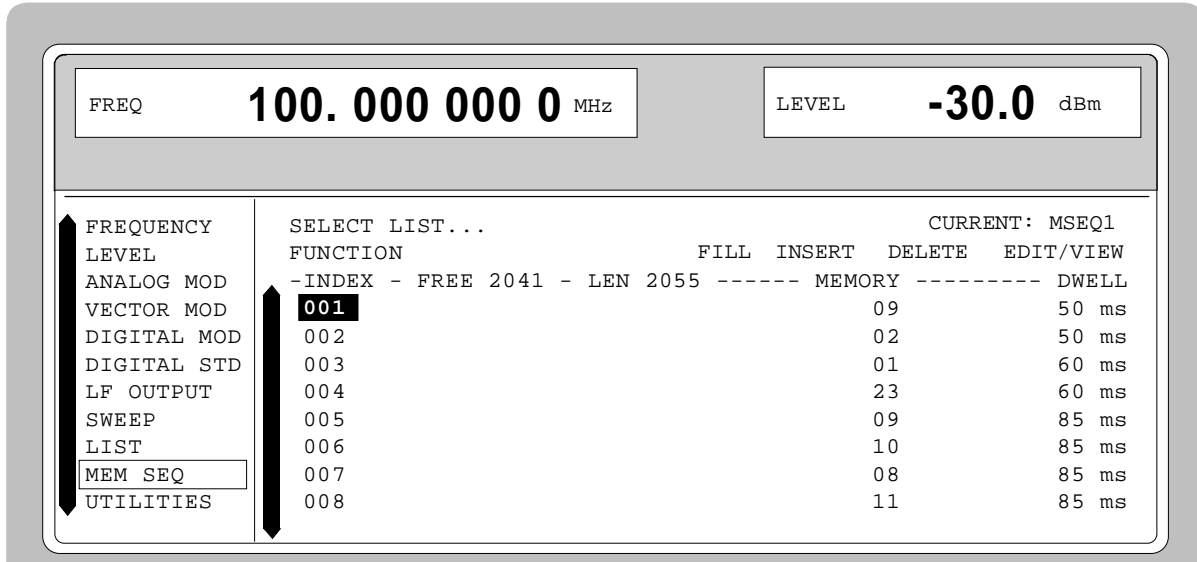

Fig. 2-253 Menu MEM SEQ - EDIT page

INDEX Index of the list.

FREE Indication of the list entries still vacant.

LEN Length of the current list.

MEMORY Parameter: number of memory location; range 1 to 50.

DWELL Parameter: dwell time; specified range 50 ms to 60 sec, step width 1 ms.

2.29 Utilities

The UTILITIES menu contains submenus for general functions which do not directly relate to the signal generation.

2.29.1 IEC-Bus Address (SYSTEM-GPIB)

Submenu SYSTEM-GPIB offers access to the remote-control address. The setting range is 0 to 30. At the point of delivery address 28 is set.

Menu selection: UTILITIES -SYSTEM -GPIB

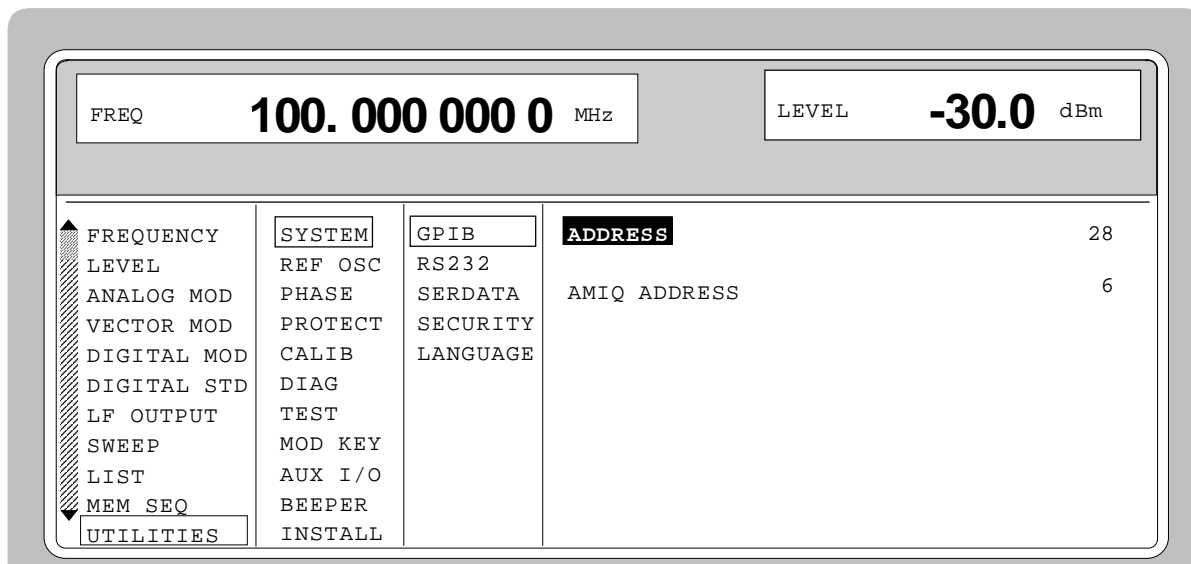

Fig. 2-254 Menu UTILITIES -SYSTEM -GPIB

ADDRESS Input value of the IEC-bus address
IEC/IEEE-bus command : SYST:COMM:GPIB:ADDR 28

AMIQ ADDRESS IEC/IEEE-bus address of AMIQ.

2.29.2 Parameter of the RS232 Interface (SYSTEM-RS232)

Submenu SYSTEM-RS232 offers access to the configuration of the RS-232 interface. The pin assignment of the interface corresponds to the pin assignment of a PC.

Menu selection: UTILITIES - SYSTEM - RS232

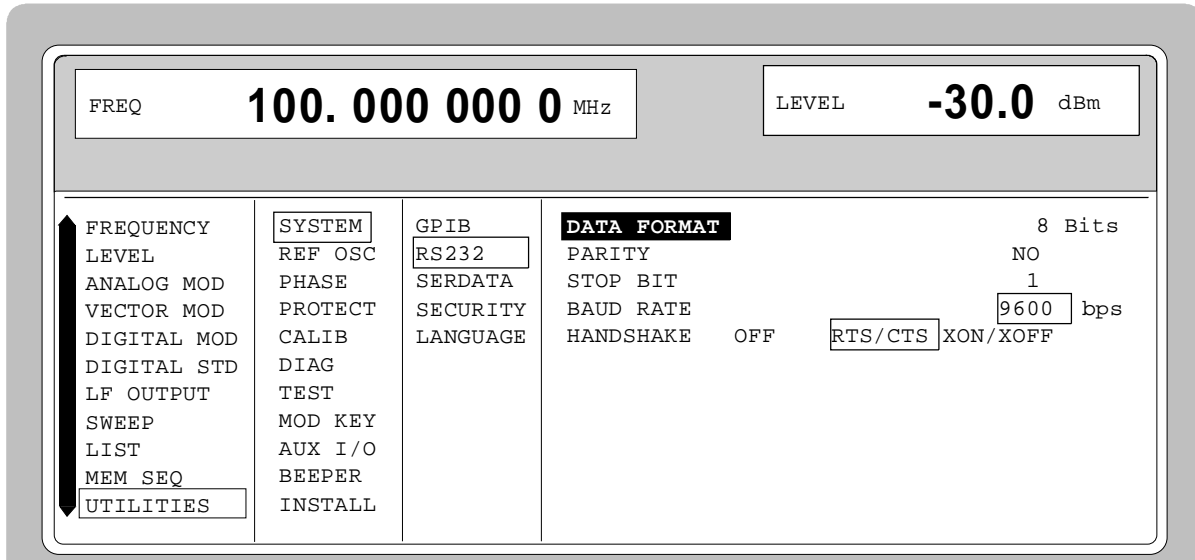

Fig. 2-255 Menu UTILITIES - SYSTEM - RS232

DATA FORMAT Indication of the number of data bits. This value cannot be changed.

PARITY Indication of parity. This value cannot be changed.

STOP BIT Indication of the number of stop bits. This value cannot be changed.

BAUD RATE Selection of the baud rate.
IEC/IEEE-bus command : SYST:COMM:SER:BAUD 9600

HANDSHAKE Selection of the handshake.

OFF No handshake
IEC/IEEE-bus command : SYST:COMM:SER:PACE NONE
: SYST:COMM:SER:CONT:RTS ON

RTS/CTS Hardware handshake using the interface lines RTS and CTS. This mode always is to be preferred to XON/XOFF mode, if permitted by the configuration of the host computer.
IEC/IEEE-bus command : SYST:COMM:SER:CONT:RTS RFR

XON/XOFF Software handshake using the ASCII codes 11h <XON> and 13h <XOFF>. This mode is not recommended for binary data and for baud rates above 9600 baud.
IEC/IEEE-bus command : SYST:COMM:SER:PACE XON

2.29.3 Parameter of the SER DATA Input (SYSTEM-SERDATA)

Submenu SYSTEM-SERDATA offers access to the configuration of the SERDATA input.

Menu selection: UTILITIES - SYSTEM - SERDATA

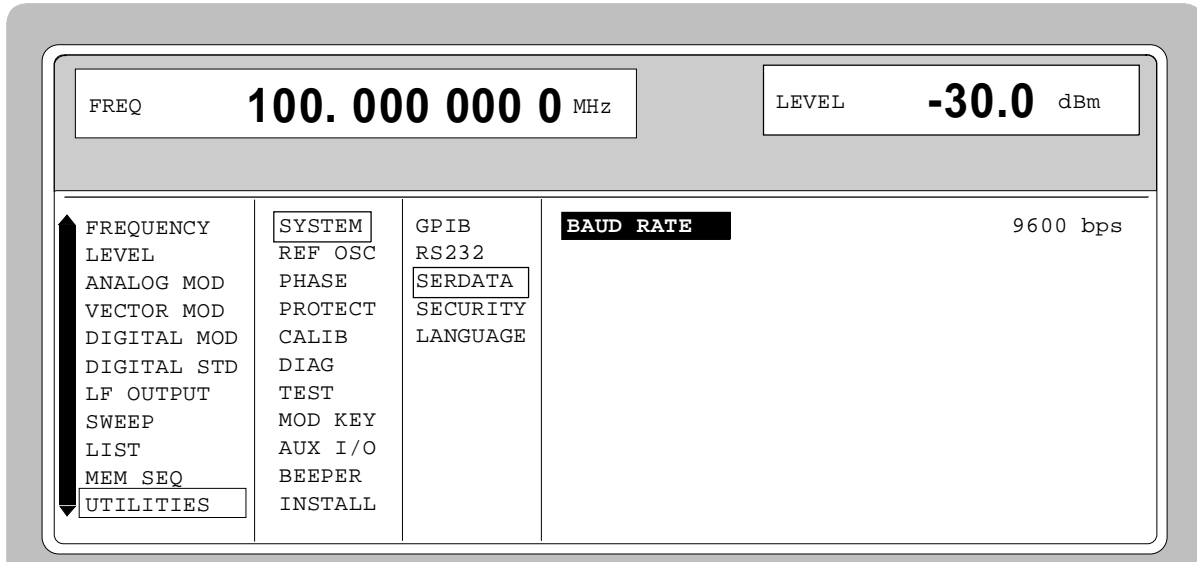

Fig. 2-256 Menu UTILITIES - SYSTEM - SERDATA

BAUD RATE

Selection of the baud rate.

IEC/IEEE-bus command : SYST:COMM:SDAT:BAUD 9600

2.29.4 Suppressing Indications and Deleting Memories (SYSTEM-SECURITY)

For security interests, indications can be suppressed and memories deleted in the SYSTEM-SECURITY submenu.

Menu selection: UTILITIES - SYSTEM-SECURITY

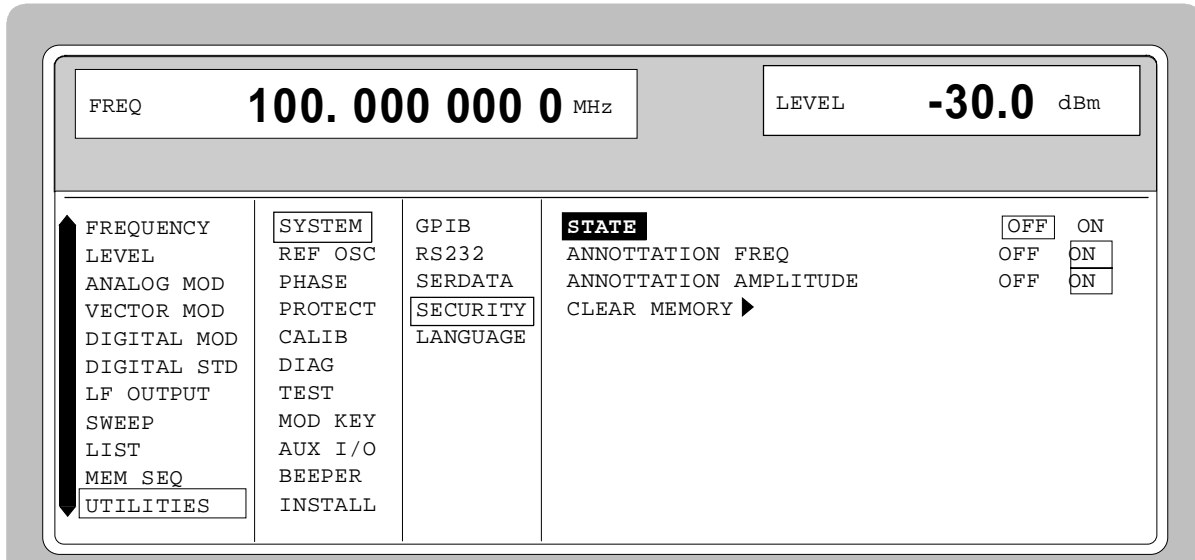

Fig. 2-257 Menu UTILITIES - SYSTEM-SECURITY

STATE

Selection of the SECURITY state

ON Locks the suppression of the indications. Can only be set via IEC bus.

OFF Deactivates the interlock of the indication suppression. The preset state is set in the transition ON→OFF, and all data stored such as settings, with the exception of the DM lists are deleted. Can only be set via IEC bus.

IEC/IEEE-bus command :SYST:SEC OFF

ANNOTTATION FREQ

OFF All frequency indications are suppressed.

ON The frequency setting is displayed..

IEC/IEEE-bus command :DISP:ANN:FREQ ON

ANNOTTATION AMPLITUDE

OFF All level indications are suppressed.

ON The level setting is displayed.

IEC/IEEE-bus command :DISP:ANN:AMPL ON

CLEAR MEMORY ►

Deletion of all data stored such as settings, user correction and list settings stored, with the exception of the DM lists.

For this action, two commands are necessary at the IEC bus:

IEC/IEEE-bus command :SYST:SEC ON; SEC OFF

2.29.5 Indication of the IEC-Bus Language (LANGUAGE)

Submenu UTILITIES-SYSTEM LANGUAGE indicates the IEC-bus language and the current SCPI version.

2.29.6 Reference Frequency Internal/External (REF OSC)

In the internal-reference operating mode, the internal reference signal at a frequency of 10 MHz is available at the REF socket (rear of the instrument).

Signal level: V_{eff} (EMF, sine) = 1 V.

The frequency of the internal reference oscillator can be detuned via the EXT TUNE input (rear of the instrument). Input voltage range ± 10 V, pulling range $\pm 1 \times 10^{-6}$.

The external detuning is possible in both states of the ADJUSTMENT STATE (ON or OFF) unless option SM-B1, reference oscillator OCXO, is fitted. If option SM-B1, reference oscillator OCXO, is fitted, the detuning via the TUNE input is only possible if the ADJUSTMENT STATE selection has been switched to ON in the UTILITIES-REF OSC menu.

In the external-reference operating mode, an external signal at a frequency of 1 MHz to 16 MHz (spacing 1 MHz) is to be fed into socket REF. The setting to external frequency is effected in the UTILITIES-REF OSC menu.

Signal level: $V_{\text{eff}} = 0.1$ to 2 V

The message "EXT REF" is displayed in the status line in the header field of the display in the external-reference operating mode.

Menu selection: UTILITIES - REF OSC

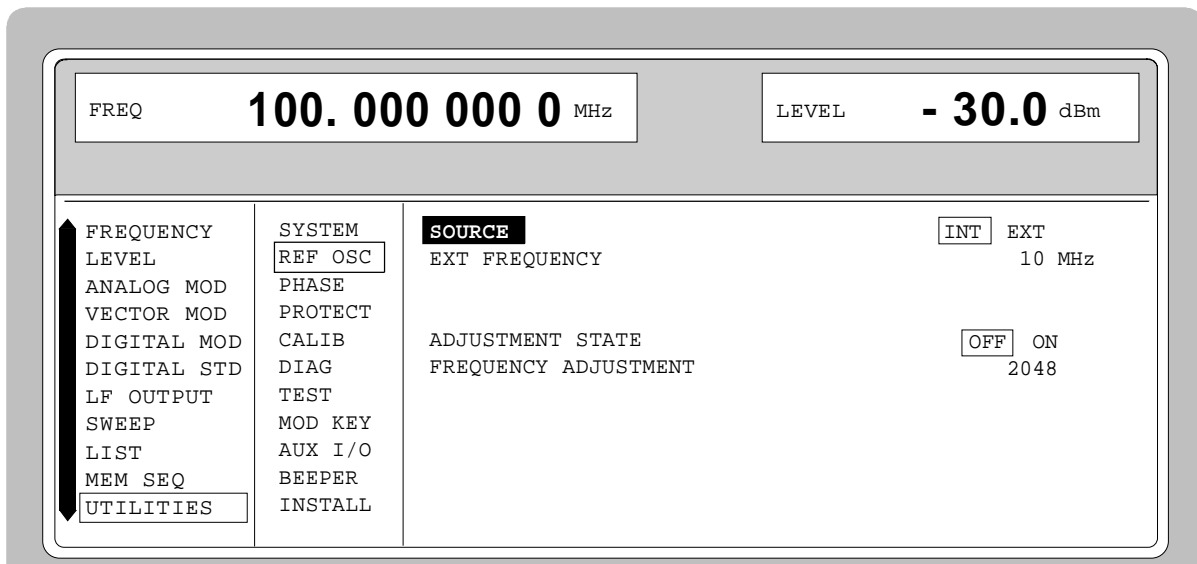

Fig. 2-258 Menu UTILITIES - REF OSC (preset setting)

SOURCE

Selection of the operating mode.

INT Internal-reference operating mode

EXT External-reference operating mode

IEC/IEEE-bus command SOUR:ROSC:SOUR INT

EXT FREQUENCY	Input value of the external reference frequency (1 MHz to 16 MHz, spacing 1 MHz). IEC/IEEE-bus command SOUR:ROSC:EXT:FREQ 10E6
ADJUSTMENT STATE	<p>OFF Tuning value of the internal reference frequency as calibrated (cf. menu UTILITIES-CALIB)</p> <p>ON Tuning value according to setting value FREQUENCY ADJUSTMENT. Option SM-B1, reference oscillator OCXO, is switched off. Only the standard reference oscillator is in operation.</p> <p>IEC/IEEE-bus command SOUR:ROSC:ADJ:STAT ON</p>
FREQUENCY ADJUSTMENT	Input value in the range 0 to 4095 to set the internal reference frequency. Pulling range $\pm 4 \times 10^{-6}$ IEC/IEEE-bus command SOUR:ROSC:ADJ:VAL 2048

2.29.7 Phase of the Output Signal (PHASE)

Menu UTILITIES-PHASE offers access to the phase setting of the RF output signal with respect to a reference signal of the same frequency.

Menu selection: UTILITIES - PHASE

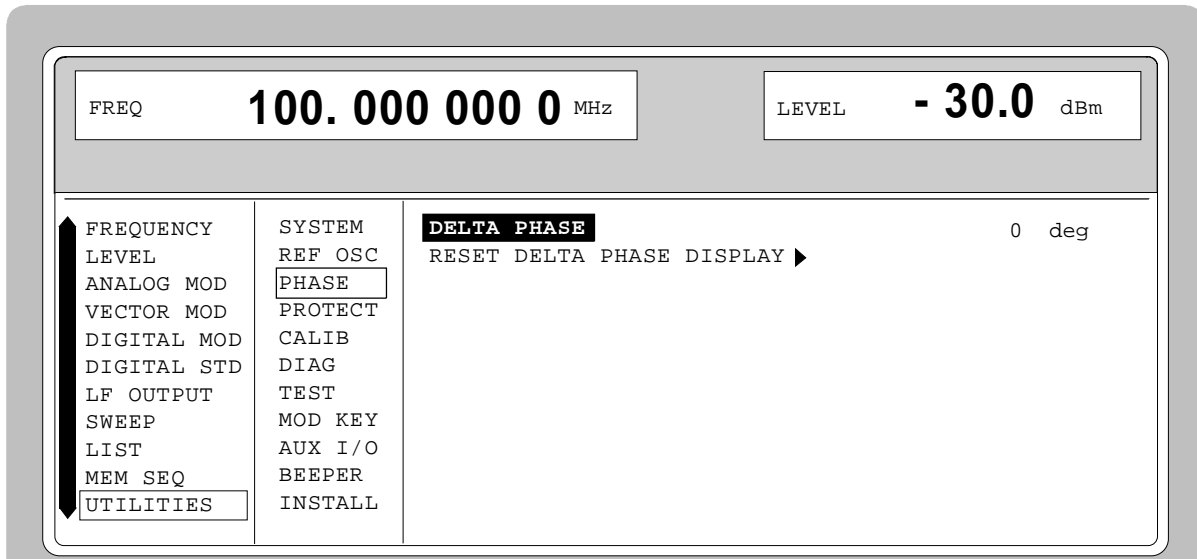

Fig. 2-259 Menu UTILITIES - PHASE (preset setting)

DELTA PHASE	Setting value of the phase. IEC/IEEE-bus command : SOUR:PHAS 10 DEG
RESET DELTA PHASE DISPLAY ►	Sets the display of the DELTA PHASE to 0 without the phase of the output signal being influenced. IEC/IEEE-bus command : SOUR:PHAS:REF

2.29.8 Password Input With Functions Protected (PROTECT)

The execution of calibrating and service functions is protected by a password. To unlock the lock-out, the correct password, a 6-digit number, has to be entered and then the [ENTER] key has to be pushed. After the instrument has been switched on, the lock-out is automatically activated.

Password 1 unlocks the lock-out for calibrations LEV PRESET and VCO SUM.

Password 2 unlocks the lock-out for calibration REF OSC.

Password 3 permits the input of the serial number and the value of the counter for POWER ON, operating hours and attenuator circuits.

Menu UTILITIES-PROTECT offers access to the unlocking of protected functions.

Menu selection: UTILITIES - PROTECT

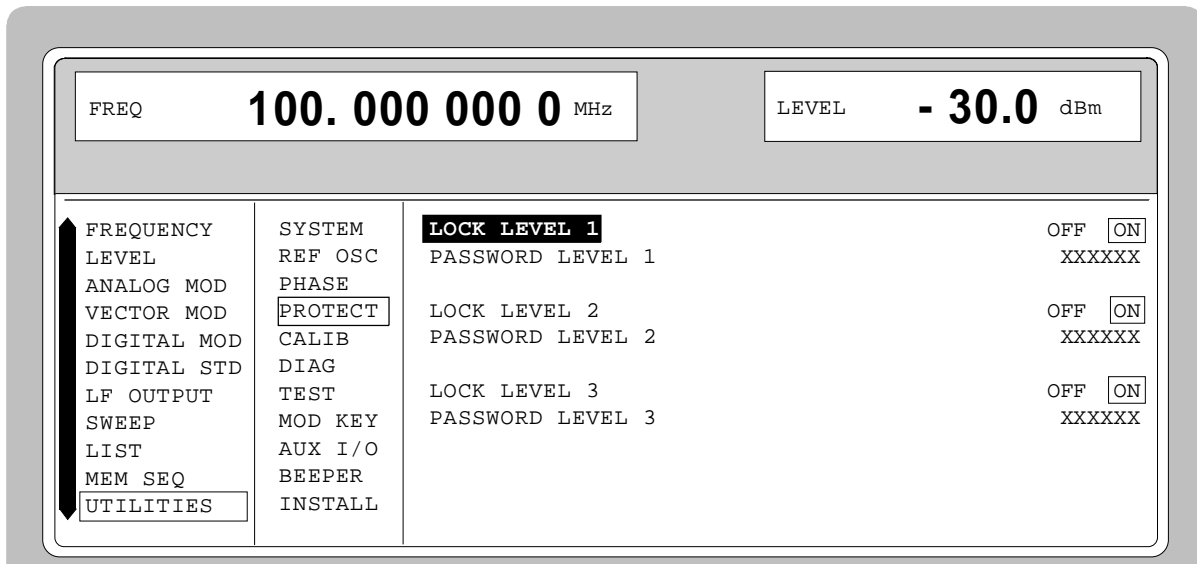

Fig. 2-260 Menu UTILITIES - PROTECT (preset setting)

LOCK LEVEL x

Activating/deactivating the lock-out.

ON The lock-out is activated.

OFF The cursor automatically wraps to the input of the password. After the password has been entered, the lock-out is deactivated.

IEC/IEEE-bus command :SYST:PROT1 ON

PASSWORD LEVEL x

Input of the password; termination with [ENTER] key.

IEC/IEEE-bus command :SYST:PROT1 OFF, 123456

2.29.9 Calibration (CALIB)

For servicing, the following menus offer access to calibrating routines and correction values:

```
UTILITIES - CALIB -  ALL
                    VCO SUM
                    VECTOR MOD
                    LEV PRESET
                    REF OSC   (cf. service manual)
                    LEVEL     (cf. service manual)
                    ALC TABLE
                    LEV ATT
                    LFGEN
```

Internal calibration routines LEV PRESET and VCO SUM are protected by a password. They can only be executed if the lock-out in the UTILITIES - PROTECT menu has been unlocked. The password is PASSWORD LEVEL 1 = "123456".

Caution: *Execute calibration routines only when the instrument has warmed up*

Calibration routines LEVEL and REF OSC are described in the service manual.

Calibration ALL

CALIB ALL triggers all internal calibrations which do not require any external measuring equipment. The calibrations with external measurements are described in the service manual.

Menu selection: UTILITIES - CALIB - ALL

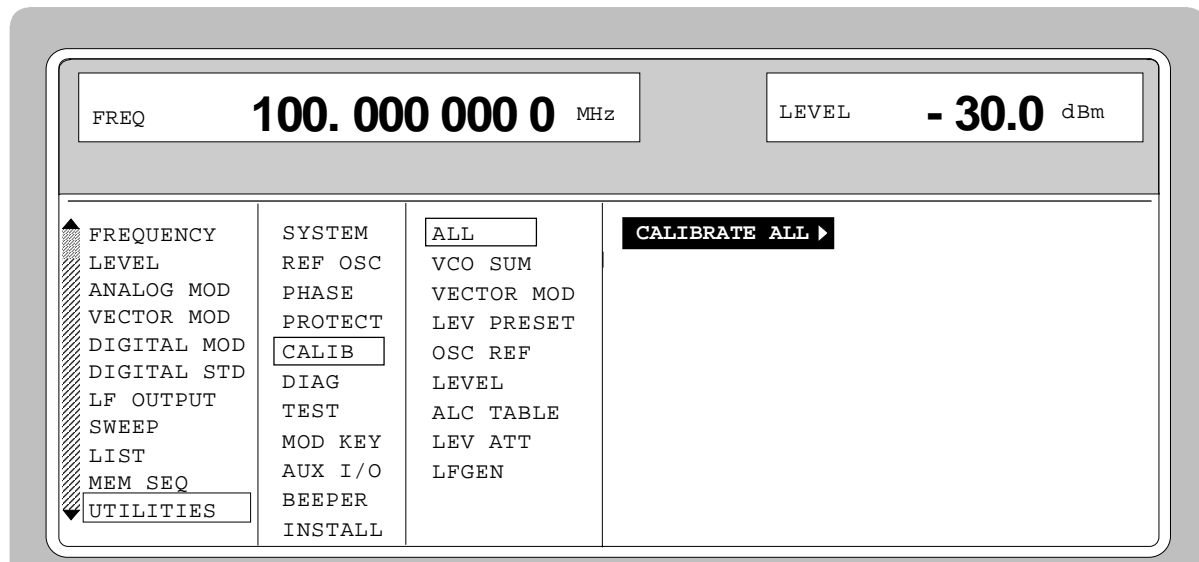

Fig. 2-261 Menu UTILITIES - CALIB - ALL

CALIBRATE ALL ► Triggers all internal calibrations.
IEC\IEEE-bus command :CAL:ALL?

Calibration VCO SUM

To synchronize the summing loop, the frequency the oscillator generates must be so close to the rated frequency that the phase control can lock in. This is effected by means of presetting values. The presetting values are stored in a table and can be renewed using internal calibration routine VCO SUM. The calibration routine needs only be executed after a data loss in the RAM or after an exchange of modules.

Menu selection: UTILITIES - CALIB - VCO SUM

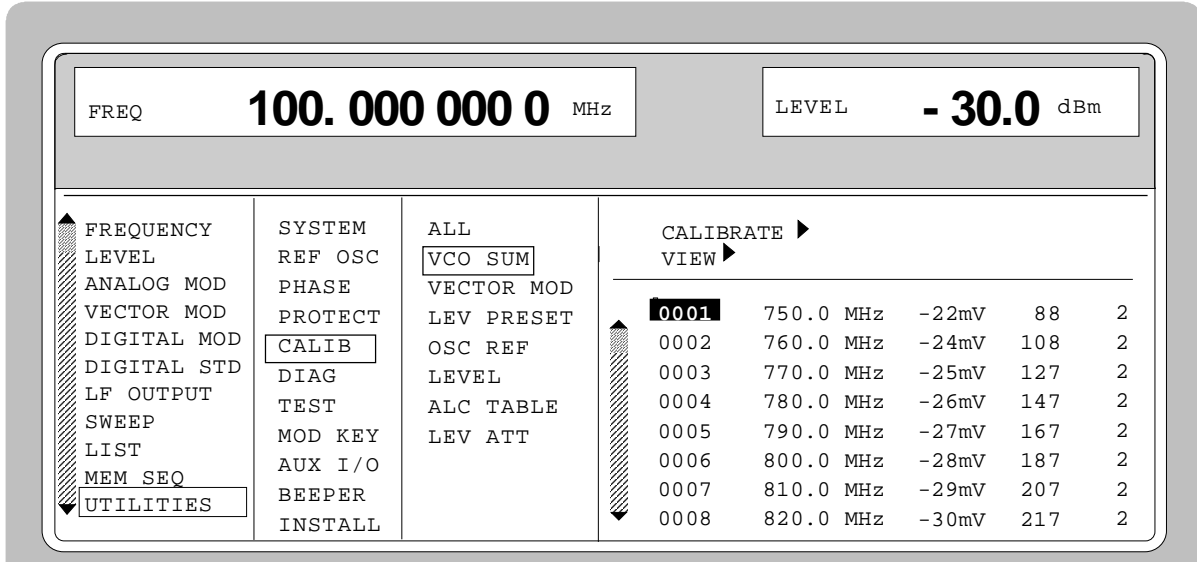

Fig. 2-262 Menu UTILITIES - CALIB - VCO SUM

CALIBRATE ► Triggers the calibration for the VCO summing loop.

IEC/IEEE-bus command :CAL:VSUM?

VIEW ► Indication of the list of correction values.

The cursor wraps to index 1 of the list. The list can be executed using the rotary knob. This index can be obtained by entering the index value on the digit block.

IEC/IEEE-bus command :CAL:VSUM:OFFS?
 :CAL:VSUM:DAC?
 :CAL:VSUM:KOS?

Calibration VECTOR MOD

In order to obtain accurate and reproducible measurements, the I/Q modulator has to be calibrated. To do this the internal calibration routine VECTOR MOD is used for adjusting the residual carrier, I/Q imbalance and quadrature offset of the modulator. Calibration should be carried out prior to the measurement but after a warm-up time of approx. 1 h or in the case of temperature changes of more than 5° C.

Menu selection: UTILITIES - CALIB - VECTOR MOD

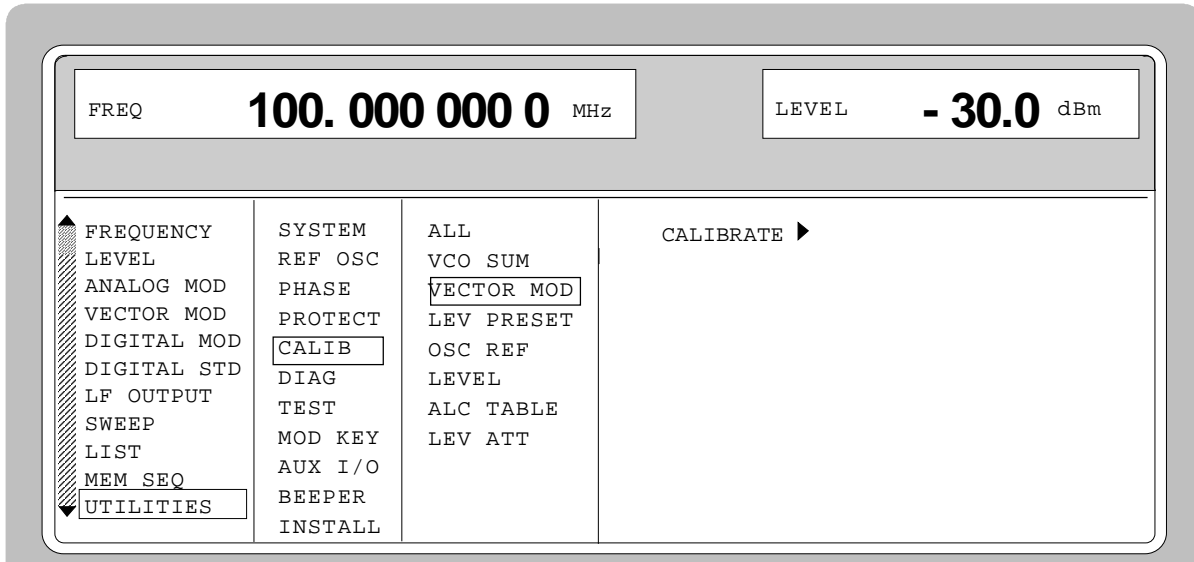

Fig. 2-263 Menu UTILITIES - CALIB - VECTOR MOD menu

CALIBRATE ▶ Triggers a calibration for the I/Q modulator, for FSIM, NDSIM and MCODE. IEC/IEEE-bus command :CAL:VMOD?

Calibration LEV PRESET

The vector modulator is aligned in terms of residual carrier, IQ imbalance and quadrature. With options SMIQB10/B20 MCOD, SMIQB14/15 FSIM and SMIQB17 NDSIM provided, calibrations are called up for these modules too and the module offset and partly the IQ imbalance are calibrated. Since the calibrations are interdependent, calling up individual calibrations is not recommended. All calibrations are run internally. Calibration should be called up after a warm-up time of approx. 1 h or in case of a temperature change of more than 5°C .

Menu selection: UTILITIES - CALIB - LEV PRESET

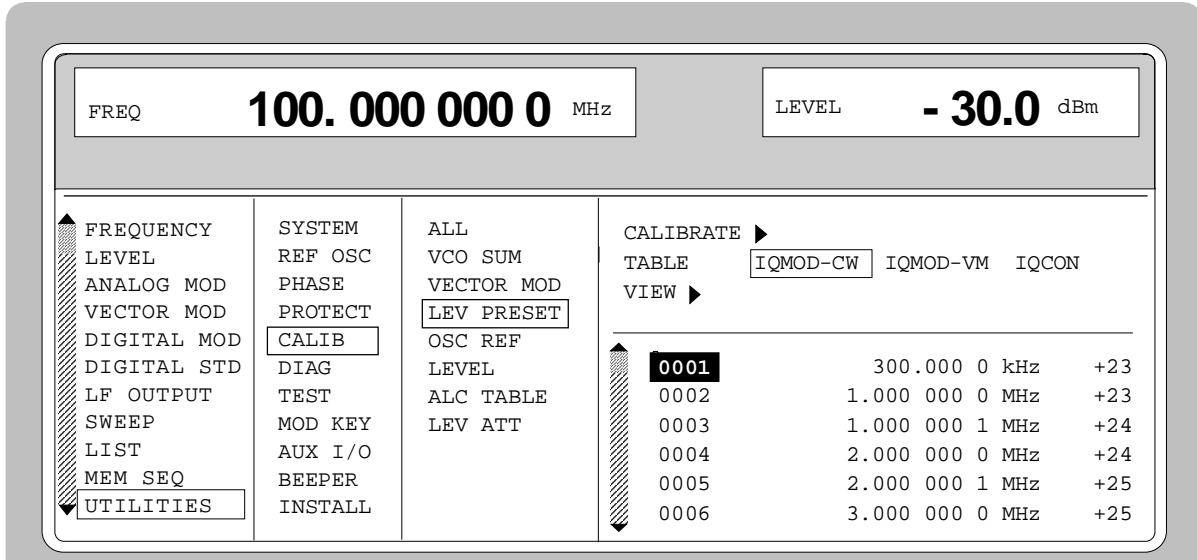

Fig. 2-264 Menu UTILITIES - CALIB - LEV PRESET

CALIBRATE ▶ Triggers the calibration for level preset.
IEC/IEEE-bus command :CAL:LPR?

The following parameters are only necessary for the indication of the correction values:

TABLE Selection of the correction values displayed by VIEW

- IQMOD-CW Correction values of module "IQ-Modulator", valid with CW mode
- IQMOD-VM Correction values of module "IQ-Modulator", valid with IQ mode
- CONVERTER Correction values of module "IQ-Converter"

VIEW ▶ The cursor wraps to index 1 of the list. The list can be executed using the rotary knob. This index can be directly obtained by entering the index value on the digit block.
IEC/IEEE-bus command :CAL:LPR:DATA?

Calibration ALC TABLE

For vector modulation or digital modulation, SMIQ is operated with the internal level control switched off. In mode ALC MODE - SAMPLE & HOLD, the level is recalibrated for each level or frequency setting. In mode TABLE, the latter does not apply since the necessary input values are taken from a table. This table can be regenerated using LEARN TABLE ►. This is required to attain an optimum level accuracy for the given operating temperature.

Menu selection: UTILITIES - CALIB - ALC TABLE

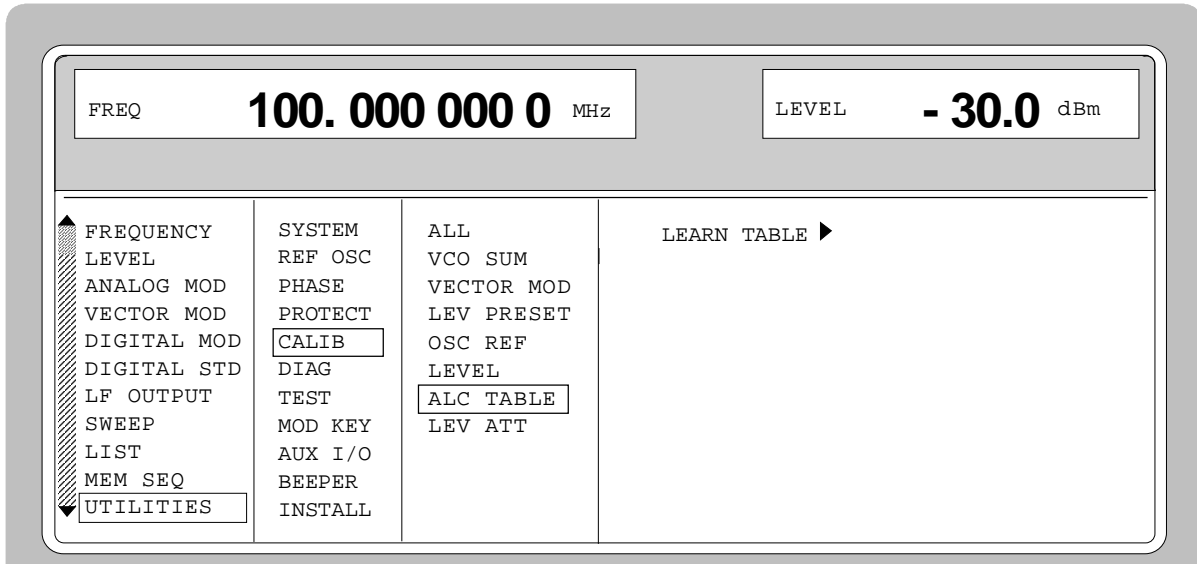

Fig. 2-265 Menu UTILITIES - CALIB - ALC TABLE

LEARN TABLE ► Triggers the generation of the new correction value for the function LEVEL-ALC-ALC OFF MODE TABLE.
 IEC/IEEE-bus command : SOUR : POW : ALC : TABL?

Calibration LEV ATT

For digital modulation (DIGITAL MOD and DIG STANDARD) and with the function LEV ATT switched on, the output level of SMIQ is reduced by a settable value in dB for a certain time (eg a slot). Calibration serves for attaining an optimum accuracy of level reduction.

Menu selection: UTILITIES - CALIB - LEV ATT

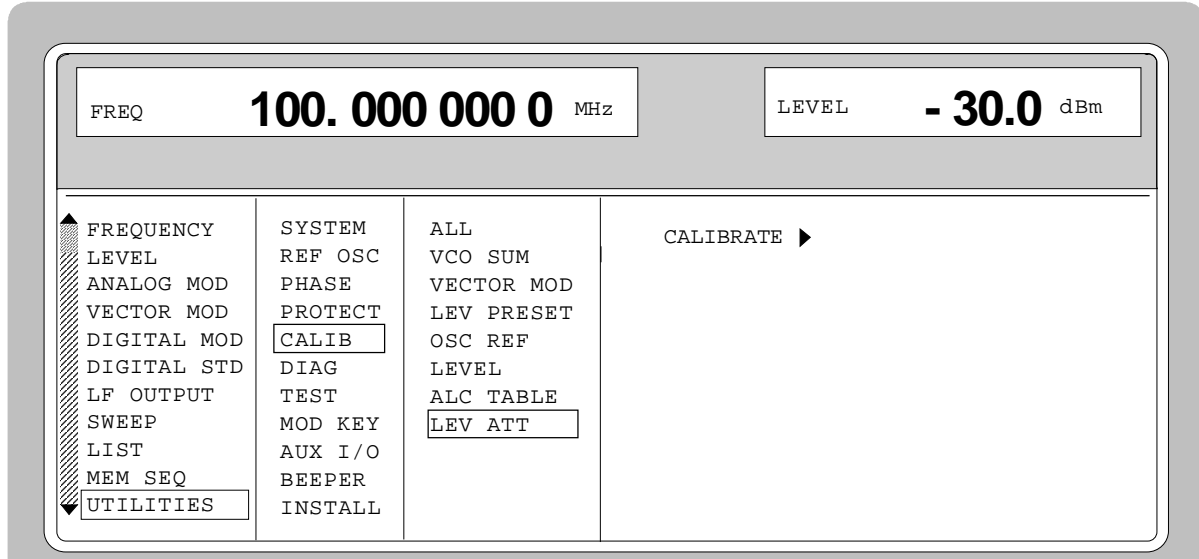

Fig. 2-266 Menu UTILITIES - CALIB - LEV ATT

CALIBRATE ► Triggers the calibration for the function LEV ATT.
 IEC/IEEE-bus command :CAL:LATT?

Calibration LFGEN

Calibrates the output level of the LF generator to 1.000 V. This calibration is only available with I/Q modulator IQMOD Var. 10 or higher.

Menu selection: UTILITIES – CALIB - LFGEN

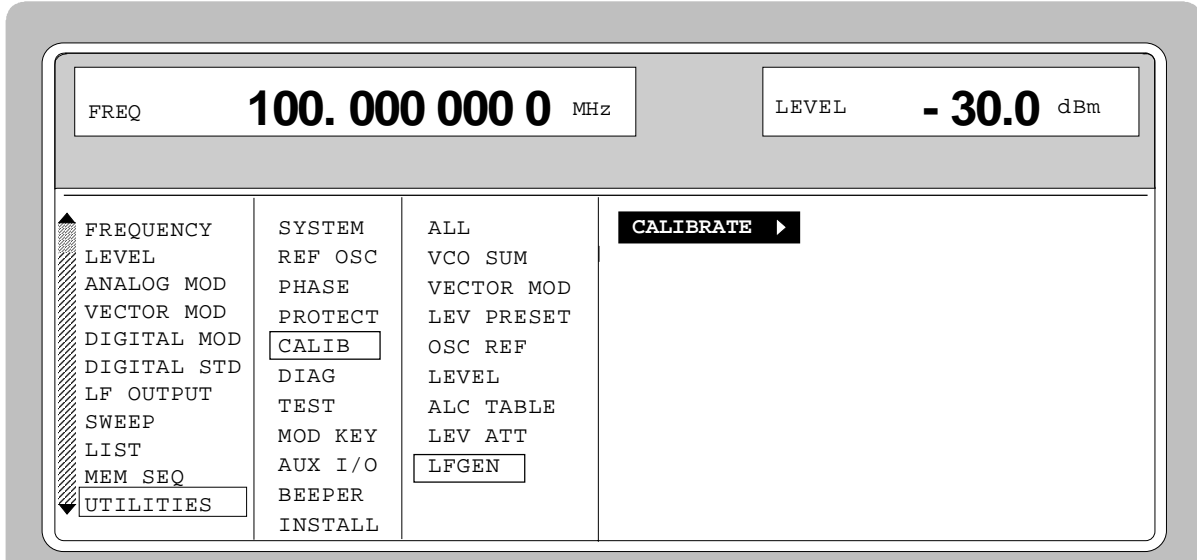

Fig. 2-267 Menu UTILITIES - CALIB – LFGEN

CALIBRATE Triggers calibration for the LFGEN function.
 IEC/IEEE bus command :CAL:LFG?

2.29.10 Indications of Module Variants (DIAG-CONFIG)

For service purposes, the modules installed can be indicated with their variants and states of modification. Submenu DIAG-CONFIG offers access to the module indication.

IEC/IEEE-bus command :DIAG:INFO:MOD?

Menu selection: UTILITIES - DIAG - CONFIG

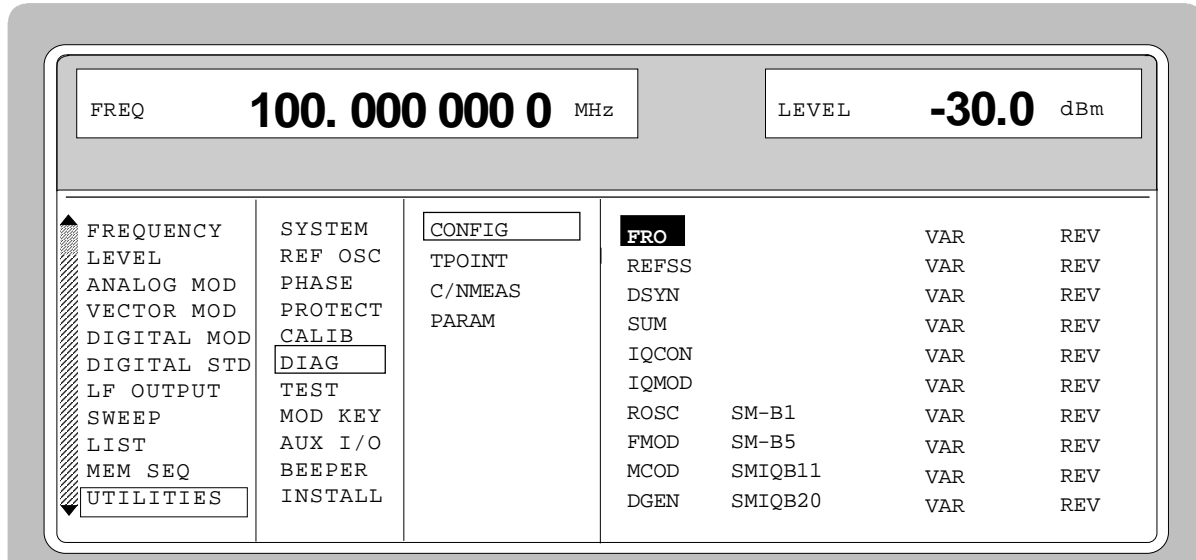

Fig. 2-268 Menu UTILITIES - DIAG - CONFIG

2.29.11 Voltage Indication of Test Points (DIAG-TPOINT)

Submenu DIAG-TPOINT offers access to internal test points. If a test point is switched on, the voltage indication is displayed in a window in the header field. For greater detail, see service manual.

Menu selection: UTILITIES - DIAG - TPOINT

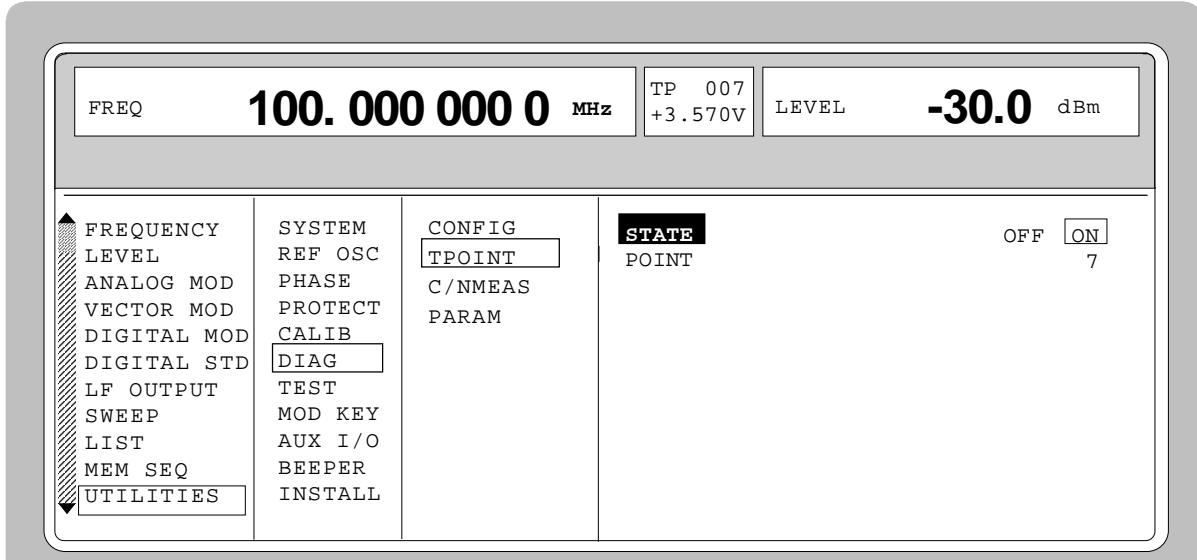

Fig. 2-269 Menu UTILITIES - DIAG - TPOINT

STATE Switching on/off the voltage indication in the header field.

POINT..... Input value of the test point.
IEC/IEEE-bus command :DIAG:POINxx?

2.29.12 Measurement of CARRIER/NOISE RATIO (DIAG-C/N MEAS)

The submenu DIAG - C/N MEAS can only be called with the option SMIQB17 (Noise generator and distortion simulator). For C/N measurements in servicing the generator can be set to the service modes as far are concerned. The carrier/noise ratio can then be easily determined this way. The submenu DIAG - C/N MEAS offers an access to these modes.

Menu selection: UTILITIES - DIAG - C/N MEAS

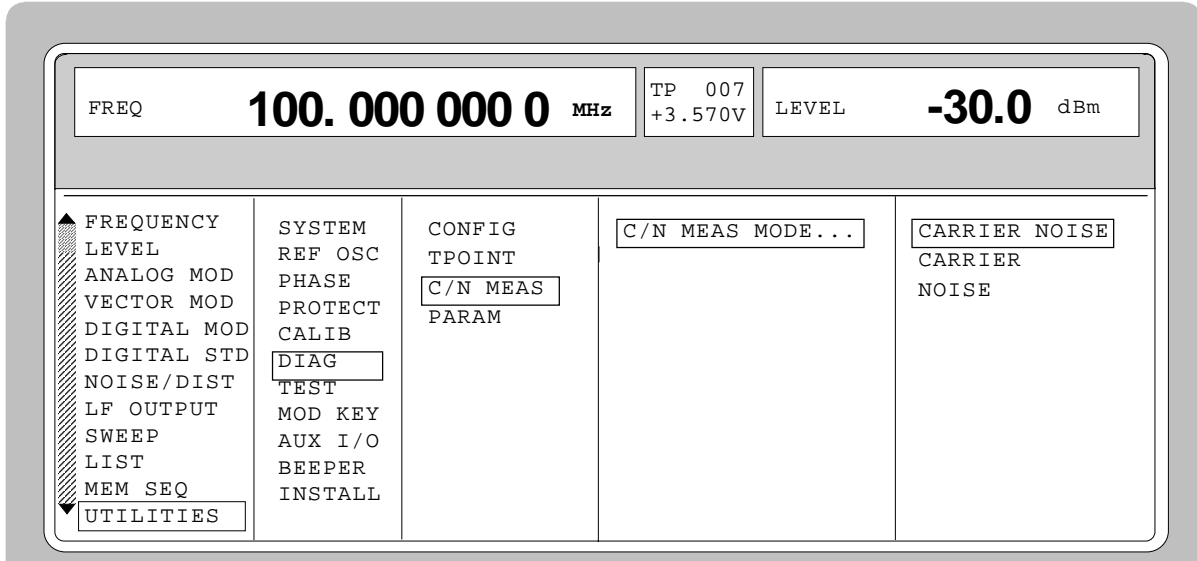

Fig. 2-270 Menu UTILITIES - DIAG - C/N MEAS

CARRIER NOISE	Noise and carrier signal IEC/IEEE-bus command	:DIAG:CNM:MODE CN
CARRIER	Only carrier signal IEC/IEEE-bus command	:DIAG:CNM:MODE CARR
NOISE	Only noise signal IEC/IEEE-bus command	:DIAG:CNM:MODE NOIS

2.29.13 Indications of Service Data (DIAG-PARAM)

Submenu DIAG-PARAMETER offers access to different parameters such as serial number, software version, operating-hours counter and attenuator circuits.

Menu selection: UTILITIES - DIAG - PARAM

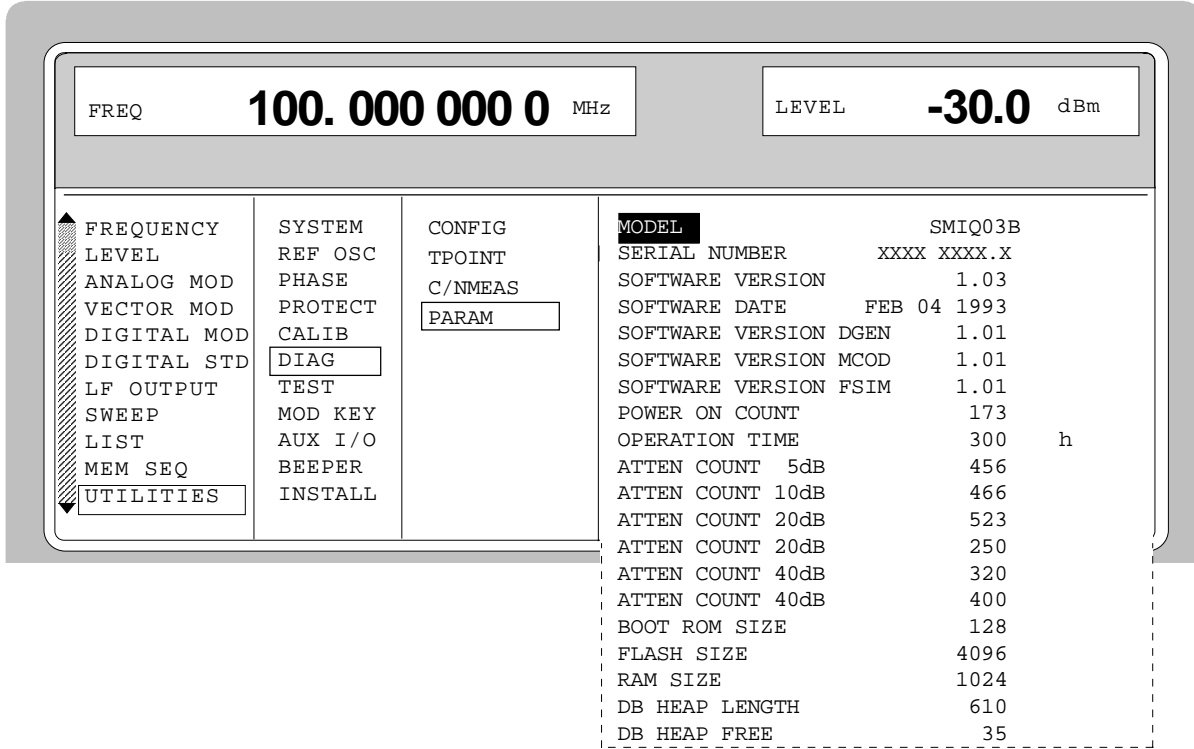

Fig. 2-271 Menu UTILITIES - DIAG - PARAM

For IEC-bus commands, cf. Chapter 3, Section "DIAGnostic System" and Section "Common Commands; *IDN?".

2.29.14 Test (TEST)

(cf. Chapter 4, Section "Functional Test")

2.29.15 Assigning Modulations to the [MOD ON/OFF] Key (MOD-KEY)

The modulations can be switched on/off in the individual modulation menus and parallelly by means of the [MOD ON/OFF] key.

For which modulations the [MOD ON/OFF] key is effective can be defined in the UTILITIES-MOD KEY menu. The key can either be effective for all modulations or for a selected one.

Function of the [MOD ON/OFF] key if effective for a type of modulation:

- Every pressing a key alters the state (ON or OFF) of the selected modulation.

Function of the [MOD ON/OFF] key if effective for all types of modulation (ALL):

- If at least one modulation is switched on, pressing the [MOD ON/OFF] key switches the modulation/s off. Which modulations were switched on is stored.

If no modulation is switched on, pressing the [MOD ON/OFF] key switches on the modulations which were last switched off using the [MOD ON/OFF] key.

On switching on using the [MOD ON/OFF] key, the modulation sources are used as defined in the modulation menus.

Access to the selection of the modulation to be switched using the [MOD ON/OFF] key is possible in the UTILITIES-MOD KEY menu.

Menu selection: UTILITIES - MOD KEY

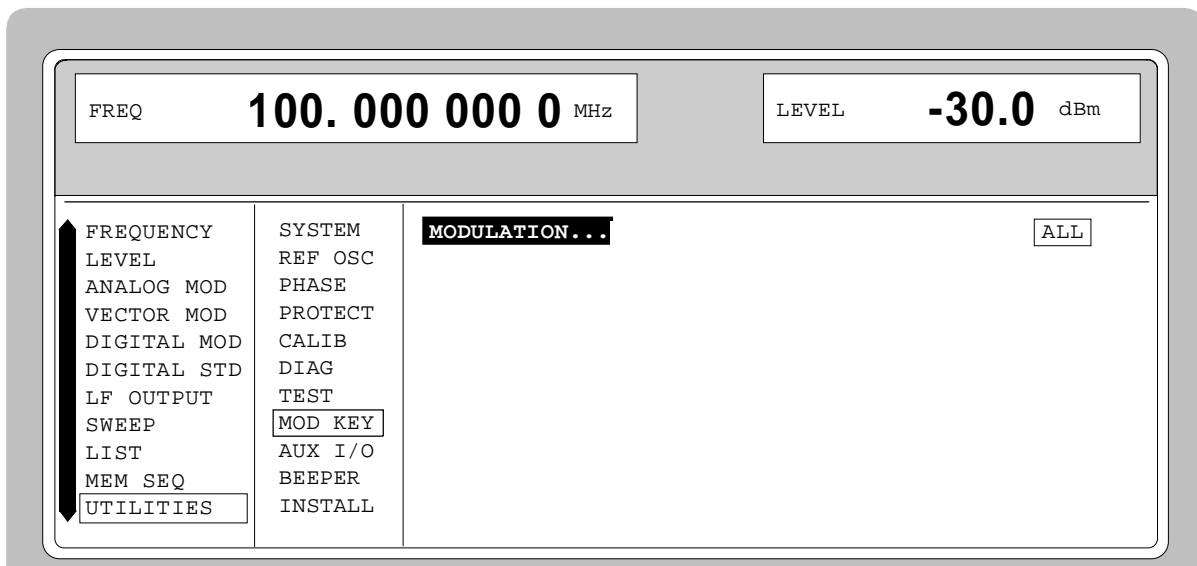

Fig. 2-272 Menu UTILITIES - MOD KEY (preset setting)

MODULATION

Open a window for selection of the modulation for which the [MOD ON/OFF] key is to be effective. The following is to choose from:
 ALL, AM, BB-AM, FM, PM, PULSE, DM, VM, FSIM, DISTO, NOISE.

Note: Preset switches off all modulations, sets the selection to ALL and stores AM 30%, AM SOURCE INT as default setting.

2.29.16 Setting Auxiliary Inputs/Outputs (AUX-I/O)

Menu UTILITIES - AUX I/O offers access to settings for the TRIGGER input, BLANK output and MARKER output. Sections Sweep, LIST Mode and Memory Sequence provide further information.

Menu selection: UTILITIES - AUX I/O

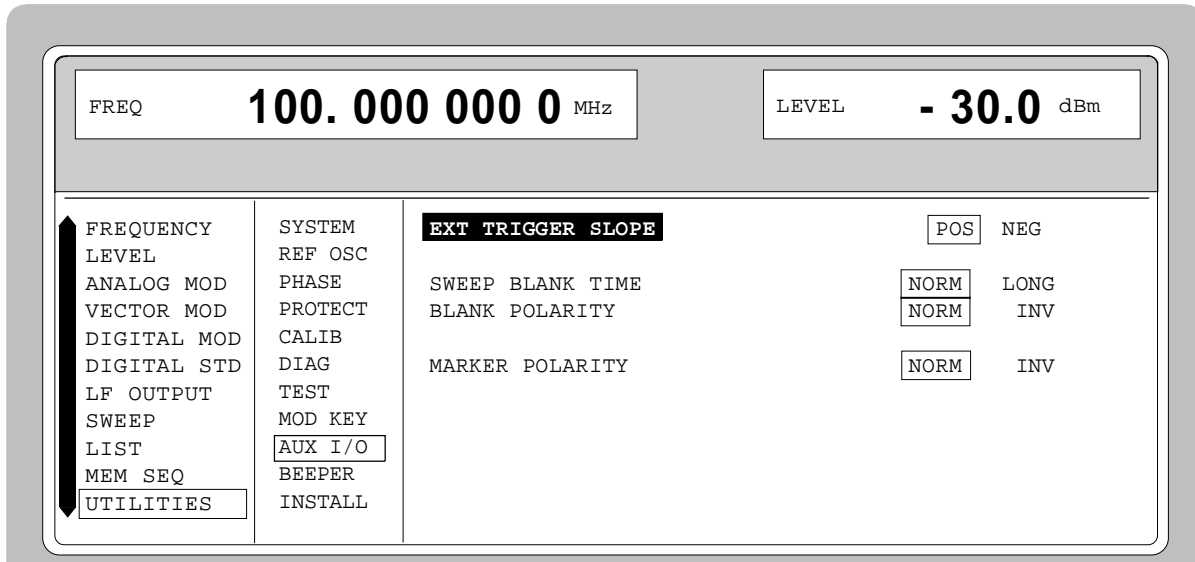

Fig. 2-273 Menu UTILITIES - AUX I/O

EXT TRIGGER SLOPE

Selection of the active edge of the external trigger signal.

POS The instrument triggers on the positive edge of the external signal.

NEG The instrument triggers on the negative edge of the external signal.

IEC/IEEE-bus command :TRIG:SLOP POS

SWEEP BLANK TIME

Selection of the blank duration.

NORM BLANK duration is set to the shortest duration possible.

LONG The BLANK duration is set for the PEN LIFT control of an XY recorder (approx. 500ms).

IEC/IEEE-bus command :SOUR2:SWE:BTIM NORM

BLANK POLARITY

Selection of the polarity for the blank signal.

NORM With active BLANK, the output signal is HIGH.

INV Polarity is inverted.

IEC/IEEE-bus command :OUTP:BLAN NORM

MARKER POLARITY

Selection of the polarity for the marker signal.

NORM The output signal is HIGH when the sweep cycle reaches the mark.

INV Polarity is inverted.

IEC/IEEE-bus command SOUR:MARK:POL NORM

2.29.17 Switching On/Off Beeper (BEEPER)

Menu UTILITIES-BEEPER offers access to the switching on/off of the beeper.

Note: Preset does not alter the current state (ON or OFF).

Menu selection: UTILITIES - BEEPER

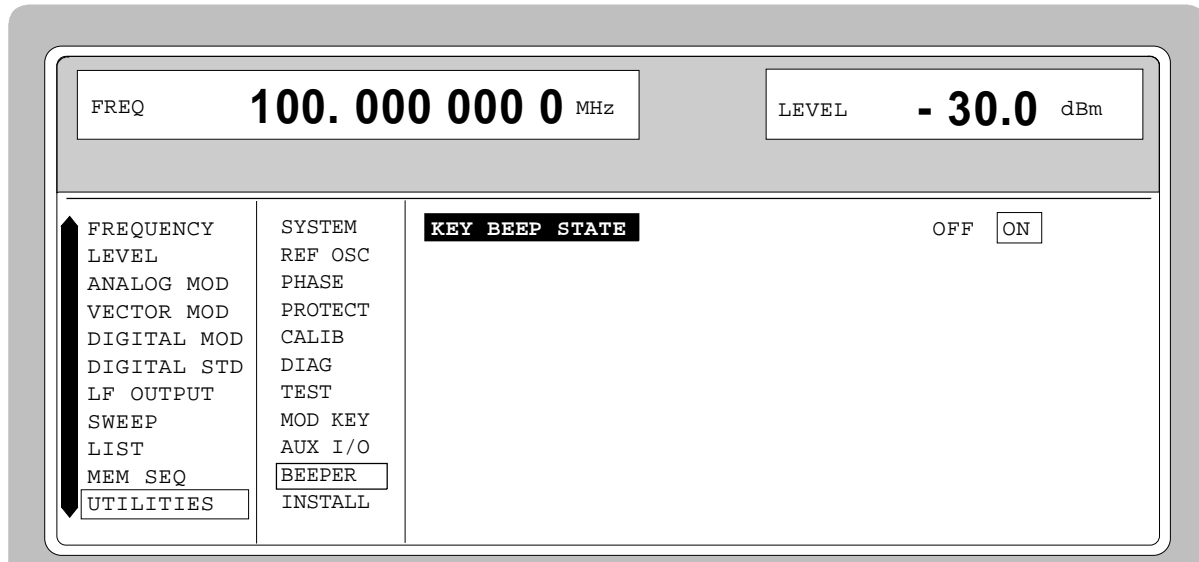

Fig. 2-274 Menu UTILITIES - BEEPER

KEY BEEP STATE

Switching on/off the beeper

IEC-bus command

:SYST:BEEP:STAT ON

2.29.18 Installation of Software Option

Options are installed in the menu UTILITIES-INSTALL by means of a keyword. The keyword is part to the equipment supplied in case of a follow-up order.

Menu UTILITIES-INSTALL gives access to the keyword entry.

Menu selection: UTILITIES - INSTALL

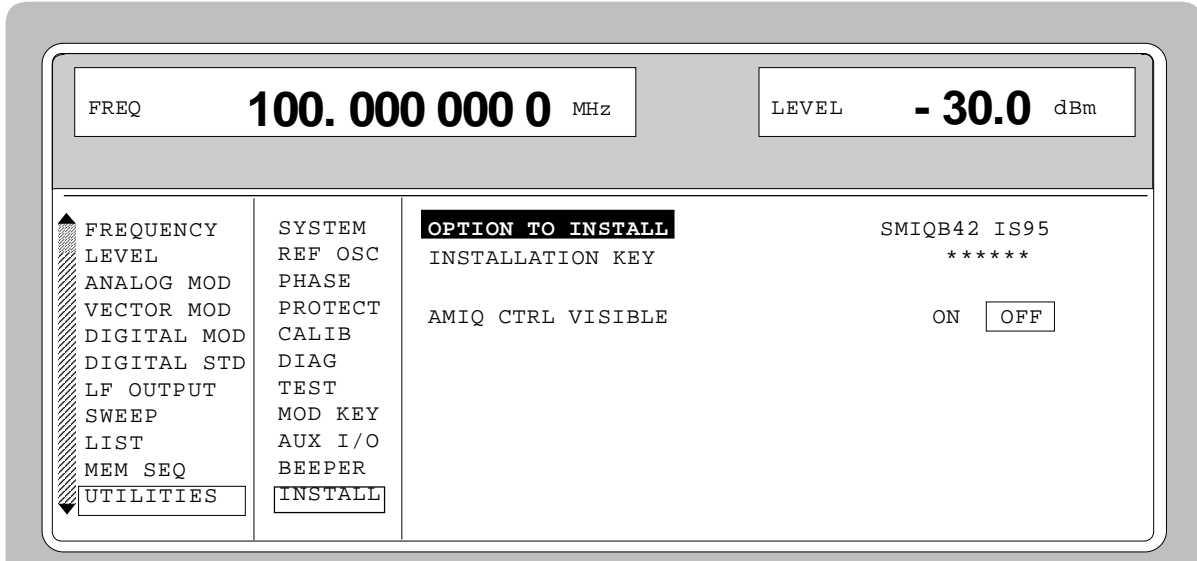

Fig. 2-275 Menu UTILITIES - INSTALL, fitted with options

- OPTION TO INSTALL** Selection of the option to be installed.

- INSTALLATION KEY** Entry of the keyword; after entry, press key [ENTER].

- AMIQ CTRL VISIBLE** Activates or deactivates menu AMIQ CTRL.

2.30 The Help System

The SMIQ has two help systems. On the one hand the context-sensitive help which is called by means of the HELP key and which gives information on the current menu. On the other hand, auxiliary texts can be selected according to headwords in alphabetical order by accessing menu HELP.

HELP Key

The yellow HELP key can be pressed at any point in time. The current setting menu is faded out and context-sensitive text faded in. The help panel can be exited by means of the RETURN key.

Menu HELP

After calling the help menu, access to all auxiliary texts is possible via an index. Operation is analog to menu operation.

- Set the menu cursor to the index desired using the shaft encoder.
- Press the [SELECT] key.
- The information for the index marked is displayed.
- Press the [RETURN] key to exit the menu.

2.31 Status

By means of a STATUS page, the SMIQ permits an overview over all settings of the instrument. The settings are displayed in an abbreviated form. The STATUS page is called by pressing the [STATUS] key. Return to the preceding menu is effected using the [RETURN] key.

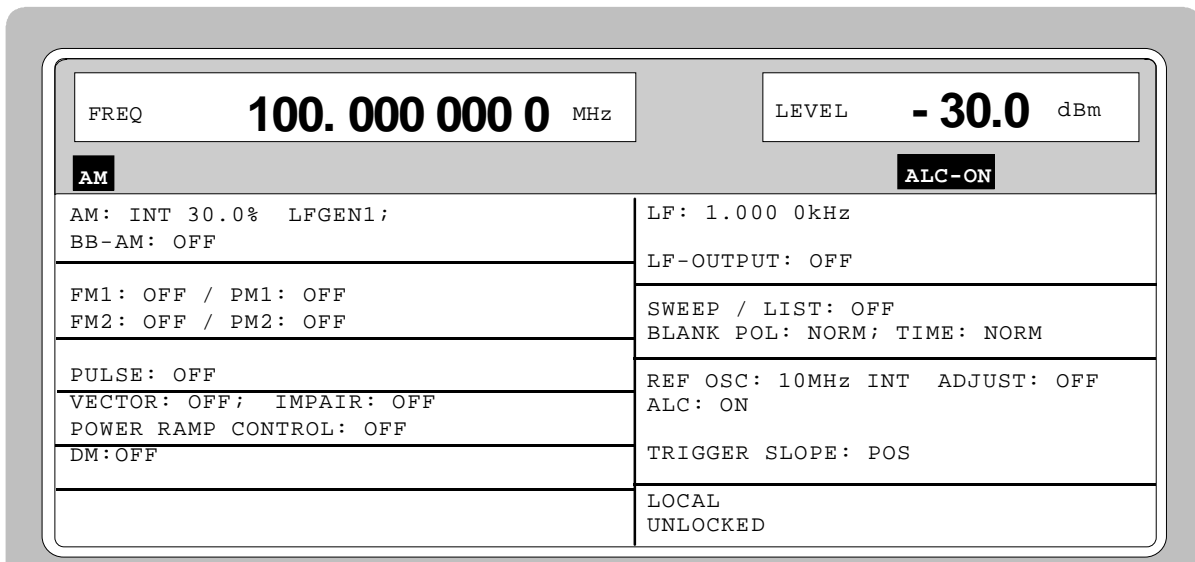

Fig. 2-276 Menu STATUS page

2.32 Error Messages

The SMIQ displays error and caution messages in a different manner, depending on how long, for a short period of time or permanently, the cause exists.

Short-term message

The short-term message is displayed in the status line. Part of it overwrites the status indications and disappears after approx. 2 seconds or in the case of a new entry.

The instrument shows, e.g., short-term messages if the attempt is made to enter an overrange or if incompatible operating modes deactivate one another.

Long-term message

The long-term message is displayed in the status line by means of the message "WARNING" or "ERROR". Pressing the [ERROR] key calls the ERROR page in which the messages are entered. Several messages can be entered at the same time. The long-term message remains existing until there is no cause any more. The ERROR page is exited using the [RETURN] key.

The instrument displays, e.g., the long-term message "ERROR" if there is a hardware error or "WARNING" if overrange settings have been made.

- Notes:** – An error message "ERROR" does not necessarily point to a defect instrument. There are various operating states which can cause an ERROR message. E. g. if the instrument is set to external reference but no external reference is connected.
- Error 313 indicates the loss of calibration data and is also applicable in case of a cold start (key [PRESET] is pressed during switch-on). The calibration values can be restored with internal calibration routines. These routines are accessible via menu UTILITIES-CALIB (see section on calibration).

The ERROR page offers access to long-term messages if the [ERROR] key is pressed.

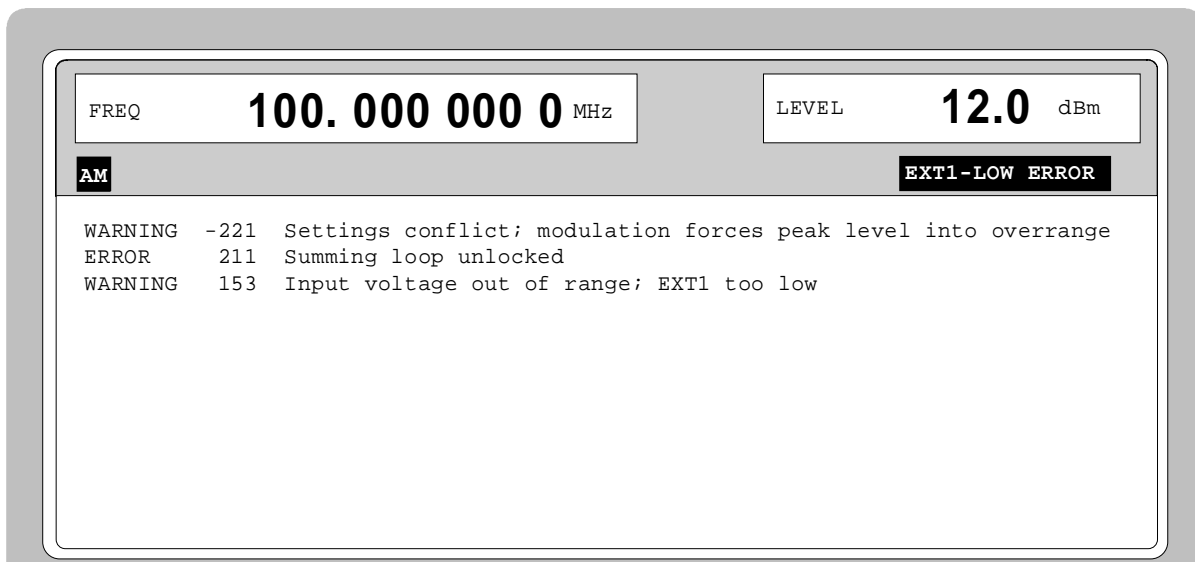

Fig. 2-277 ERROR page

A list of the possible error messages is to be found in annex B.

Index

#

$\pi/4$ DQPSK modulation 2.88

A

A field (DECT) 2.332, 3.59
Abort actions triggered 3.17
Active edge (external trigger) 2.114, 2.429, 3.77, 3.214
Additional 3.180
 mobile station 3.192
Additional MS (Enhanced Channels) 2.260
Address
 IEC/IEEE bus 2.410, 3.202
Addressed commands A.3
ALC TABLE- calibration 2.421, 3.144
AM/AM conversion 2.387
AM/PM conversion 2.387
Amplitude marker (RF sweep) 2.397
Amplitude marker (RF-sweep) 3.112
Amplitude modulation 2.59, 3.50
 frequency 2.59, 3.50
 test procedure 5.31
ANTENNA DIVERSITY (3GPP W-CDMA) 2.196, 3.170
ARB 2.341, 3.18
 AMIQ compatible commands 3.29
 Interpolation rate 2.343
 Use of WinIQSIM 2.344
 Waveform format 3.23
ARB waveform
 Automatic SMIQ settings 2.352, 3.21
 converting 3.29
 Creating manually 3.25
 Data 3.19
 Delete 2.352, 3.19
 IQ level 2.355, 3.22
 Select 2.349, 3.19
Arbitrary Waveform Generator 2.341, 3.18
 test procedure 5.77
Area constant (fading simulation) 2.77, 3.88
ASCII character (#) 3.11
Asterix 3.11
Attenuator 2.48
Attenuator circuits
 indication 2.427
ATTENUATOR MODE FIXED 5.17
AWGN signal 2.383

B

B field (DECT) 2.332, 3.60
Base station
 CDMA 2.130
 configuration (3GPP W-CDMA) 2.193
 DECT 2.318
 Enhanced 3.183
 GSM/EDGE 2.301
 NADC 2.262
 name (3GPP W-CDMA) 2.194
 OCNS 3.187
 PDC 2.279

PHS 2.115
 W-CDMA 2.150
Baseband filter
 3GPP W-CDMA 2.182, 3.165
 GSM/EDGE 3.97
 W-CDMA 2.157, 3.154
Battery test
 data generator 4.2
 RAM 4.2
 Test procedure 5.41
Baud rate
 RS232 2.411, 3.202, A.5
 SERDATA 2.412, 3.202
BB-AM 2.60, 3.50
BB-AM output 2.7
Beeper 2.430, 3.202
BER (connector) 1.15
BER interface 2.19
BIRTH-DEATH
 Dwell period 2.84, 3.92
Bit clock
 DECT 2.326, 3.56
 digital modulation 2.111, 3.76
 NADC 2.270, 3.118
 PDC 2.287, 3.127
 PHS 2.123, 3.137
BIT CLOCK input/output 2.7, 2.95, 3.77
Bit error (Enhanced Channels) 3.184, 3.185, 3.190
Bit error rate test
 continuous measurement 3.30
 single measurement 3.30
Bit error rate test BERT 2.366, 2.368, 3.30
 Break 2.375
 Continuous measurement 2.370
 Cyclic random sequences 2.374
 Cyclic restart 2.375
 Data interruption 2.374
 DECT 2.319
 Integrating 2.375
 Interrupted random sequence 2.375
 Memory wrap-around 2.375
 mode 2.370, 3.30
 problems and solutions 2.377
 Single measurement 2.370
 statistics 2.376
 synchronization 2.377
 termination criteria 2.376
 test procedure 5.63
 value range 2.376
Bit error rates 2.230
Bit errors (Enhanced Channels) 2.244
BITCLK output 2.15
BLANK output 2.21, 2.394, 2.402, 2.429
Blank time 2.429, 3.149
Block data 3.44
Block error rate measurement BERT
 continuous measurement 2.379
 operating mode 2.379
 termination criteria 2.381
Block error rate measurement BLER 3.34
 continuous measurement 3.34
 single measurement 2.379, 3.34
 statistics 2.380
 synchronization 2.382

- value range 2.380
 - Boolean parameter 3.9
 - Brief instructions 3.1
 - Brightness
 - control (oscilloscope)..... 2.395
 - display 1.2, 2.11
 - Broadband amplitude modulation (BB-AM) 2.60, 3.50
 - test procedure 5.33
 - Broadband FM
 - test assembly 5.3
 - Burst
 - Normal Burst (GSM/EDGE) 2.316
 - BURST GATE input/output 2.15
 - Burst gate signal (digital modulation) 2.93, 2.112, 3.71
 - Burst type
 - GSM/EDGE 2.316
 - BxT rate (digital modulation) 2.107, 3.75
- C**
- Calibration
 - ALC TABLE 2.421, 3.144
 - disable 3.205
 - FADING SIM 3.37
 - LEV ATT 2.422, 2.423, 3.37
 - LEV PRESET 2.420, 3.38
 - LEVEL 2.417, 3.38
 - password 2.417, 3.205
 - REF OSC 2.417, 3.38
 - VCO SUM 2.418, 3.39
 - VECTOR MOD 2.419, 3.39
 - Cancellation 2.228, 2.232
 - CARRIER/NOISE RATIO 2.384, 5.75
 - Caution messages 2.433
 - CCDF (3GPP W-CDMA) 2.191
 - CCDF (ARB) 2.343
 - CDMA 2.130, 3.102
 - CDVCC (NADC) 2.275
 - Cell station (CS)
 - DECT 2.318
 - GSM/EDGE 2.301
 - NADC 2.262
 - PDC 2.279
 - PHS 2.115
 - Center frequency (RF sweep) 2.396, 3.80
 - Channel (CDMA) 2.145, 3.107
 - Channel coding
 - enhanced channels 2.243
 - Enhanced Channels 3.183
 - mobile station 3.189
 - Channel configuration
 - base station (3GPP W-CDMA) 2.193
 - delete (3GPP W-CDMA) 2.180, 3.164
 - load (3GPP W-CDMA) 2.180, 3.163
 - mobile station (3GPP W-CDMA) 2.199
 - Several DPCHs (3GPP W-CDMA) 2.208
 - store (3GPP W-CDMA) 2.180, 3.163
 - Channel graph (3GPP W-CDMA) 2.210
 - Channel parameters (3GPP W-CDMA) 2.210
 - Channel simulation (3GPP W-CDMA) 2.209, 3.171
 - Channel table DPDCH 2.207
 - Channel types
 - 3GPP W-CDMA 2.170
 - Channel-coded P-CCPCH 2.236, 2.242
 - Channelization code (3GPP W-CDMA) 2.197, 2.211, 3.172
 - step width 2.209
 - Channelization code (enhanced channels) 2.251
 - Channelization code (Enhanced Channels) 3.185
 - Channelization code generator 2.174
 - Character data 3.8
 - Characteristics
 - distortion 2.387
 - Check
 - rated characteristics 5.1
 - Checksum
 - control list 3.41, 4.2
 - data list 3.40, 4.2
 - Chip clock
 - 3GPP W-CDMA 2.183, 2.187, 3.168
 - CDMA 2.143, 3.106
 - W-CDMA 2.160, 3.156
 - Chip rate
 - 3GPP W-CDMA 2.182, 2.338
 - CDMA 2.138, 3.103
 - W-CDMA 2.157, 3.154
 - CI - Channel Identifier-data field (PHS) 2.128
 - Cleaning the outside 4.1
 - Clipping (3GPP WCDMA) 2.182, 3.165
 - CLIPPING LEVEL (3GPP W-CDMA)
 - Effect on signal 2.213
 - Clock recovery (BLER) 2.382
 - Clock source
 - 3GPP W-CDMA 2.187, 3.168
 - ARB 2.354, 3.22
 - CDMA 2.143, 3.106
 - DECT 2.326, 3.56
 - digital modulation 2.111, 3.75
 - GSM/EDGE 2.308, 3.98
 - NADC 2.269, 3.118
 - PDC 2.286, 3.127
 - PHS 2.123, 3.137
 - W-CDMA 2.160, 3.156
 - CMOS-RAM 1.2
 - Code domain
 - Conflict** **2.212**
 - Display 2.212
 - Code tree of channelization codes 2.211
 - Coding (digital modulation) 2.87, 2.104, 2.108, 3.75
 - Colon 3.11
 - Color code data field (PDC) 2.293, 2.300
 - Combination of modulation methods 2.91
 - Comma 3.11
 - Command
 - addressed A.3
 - line structure 3.8
 - list C.1
 - parameter 3.9
 - recognition 3.216
 - sequence 3.217
 - structure 3.6
 - synchronization 3.217
 - syntax elements 3.11
 - universal A.3
 - Commands
 - AMIQ compatible commands 3.29
 - Common commands** **3.5, 3.14**
 - Complementary cumulative distribution function (3GPP W-CDMA) 2.191
 - Condition register** **3.219**
 - Constellation (3GPP W-CDMA) 2.192
 - Constellation of previous perch channel 2.221
 - Contrast (display) 1.2, 2.11
 - Control list (digital modulation) 2.93, 2.103, 3.71
 - checksum 3.40
 - Conversion
 - AM/AM 2.387
 - interpolation points 2.387
 - AM/PM 2.387
 - Interpolation points 2.387
 - Copy data of a base/mobile station (3GPP W-CDMA) 2.184, 3.167
 - Correlation (fading simulation) 3.88

- Counter..... 2.427, 3.42
 - Coupled parameters 2.74, 3.86
 - Coupling
 - EXT1 (AM) 2.59, 3.50
 - EXT1/2
 - FM..... 2.61, 3.78
 - PM 2.63, 3.142
 - CRC
 - Polynomial..... 2.380
 - CRC (Cyclic Redundancy Code)..... 2.333
 - Crest factor..... 2.230
 - 3GPP W-CDMA..... 2.189, 3.166
 - enhanced Channels 2.257
 - Enhanced Channels 3.188
 - Crosstalk 2.233
 - CS-ID - Cell Station ID (PHS) 2.128, 3.140
 - CW input/output..... 2.15
 - CW signal (digital modulation) 2.93
- D**
- Data
 - bits (RS232) 2.411, A.5
 - input/output 2.7, 2.13, 2.96
 - lines (IEC/IEEE-bus) A.1
 - offset 3.158
 - rate (CDMA) 2.145, 3.108
 - Data enable input..... 2.375
 - Data generator
 - installation 1.7
 - test procedure 5.41
 - Data list 2.129, 2.147, 2.275, 2.294, 2.313, 2.333, 3.69
 - checksum..... 3.41, 4.2
 - enhanced channels 2.252
 - GSM/EDGE..... 2.317
 - Data source 2.174
 - data field..... 2.251, 3.186
 - DCCH field 3.192
 - DCCH field 3.186
 - DTCH field..... 3.186
 - DTCH field..... 3.192
 - TPC field 2.252, 3.187
 - DC voltage offset
 - test procedure 5.78
 - DCL 3.215
 - Decimal point..... 2.3, 3.9
 - DECT..... 2.318, 3.53
 - test procedure 5.47
 - Default setting
 - 3GPP W-CDMA..... 2.335, 2.336
 - Default setting (3GPP W-CDMA)..... 2.180, 3.163
 - Default setting (CDMA)..... 2.138, 3.103
 - Default setting (W-CDMA) 2.156, 3.153
 - Default values (3GPP W-CDMA) 2.216
 - Delay
 - clock
 - 3GPP W-CDMA..... 2.187, 3.168
 - ARB 2.354, 3.22
 - CDMA 2.143, 3.106
 - DECT..... 2.326, 3.56
 - digital modulation 2.111, 3.76
 - GSM/EDGE..... 2.309, 3.99
 - NADC..... 2.270, 3.118
 - PDC 2.287, 3.127
 - PHS 2.123, 3.137
 - signal
 - 3GPP W-CDMA 2.186, 2.337, 3.168
 - ARB 2.347, 3.20
 - DECT..... 2.325, 3.56
 - GSM/EDGE..... 2.308, 3.98
 - NADC 2.269, 3.118
 - PDC..... 2.286, 3.127
 - PHS 2.122, 3.136
 - trigger
 - 3GPP W-CDMA 2.185, 2.336, 3.167
 - ARB 2.347, 3.20
 - CDMA 2.141, 3.105
 - DECT..... 2.325, 3.56
 - digital modulation 2.110, 3.77
 - GSM/EDGE 2.307, 3.98
 - NADC 2.268, 3.117
 - PDC..... 2.285, 3.127
 - PHS..... 2.122, 3.136
 - W-CDMA 2.159, 3.155
 - Delay range
 - Fading simulation..... 2.84
 - Delete
 - all data stored 2.413, 3.205
 - frame (DECT)..... 2.329, 3.58
 - frame (GSM/EDGE) 2.311, 3.100
 - frame (NADC) 2.272, 3.120
 - frame (PDC)..... 2.289, 3.129
 - frame (PHS)..... 2.125, 3.139
 - list 2.33
 - list entry 2.39
 - mapping (CDMA) 2.145, 3.107
 - memory..... 2.413, 3.205
 - Delimiter..... 3.215
 - Delta phase..... 2.415, 3.133
 - Demultiplexer 2.176
 - Detuning, external..... 2.414
 - Deviation
 - FM 2.61, 3.78
 - FSK (digital modulation) 2.106, 3.75
 - PM 2.63, 3.142
 - Deviation error
 - FSK..... 5.39
 - GFSK..... 5.40
 - Deviation limits
 - FM 2.62
 - PM 2.64
 - Differential coding (digital modulation)..... 2.104, 3.75
 - Digit cursor..... 2.23
 - Digital modulation..... 2.86, 3.65
 - coding 2.87, 3.75
 - constellation diagram 2.87
 - control list..... 2.103, 3.71
 - data list 2.103, 2.129, 2.147, 2.275, 2.294, 2.313, 2.333, 3.69
 - envelope control..... 2.99, 2.112
 - FSK..... 2.89
 - menu 2.101
 - modulation data 2.92, 2.102, 3.69
 - modulation methods..... 2.87
 - PRBS data 2.94
 - PSK 2.87
 - QAM 2.87
 - setting conflicts 2.91
 - test procedure 5.38
 - trigger..... 2.109, 3.77
 - Digital standard
 - 3GPP W-CDMA 2.169, 3.159
 - DECT..... 2.318, 3.53
 - GSM/EDGE 2.301, 3.96
 - IS-95 CDMA..... 2.130, 3.102
 - NADC..... 2.262, 3.115
 - PDC 2.279, 3.124
 - PHS 2.115, 3.134
 - test procedure..... 5.45
 - W-CDMA..... 2.150, 3.152
 - Digital synthesis (slot) 1.5
 - Disabling keyboard..... 3.203

- Display
 - brightness 2.11
 - contrast 2.11
 - test procedure 5.8
 - Distortion characteristics 2.387
 - calculation from polynomial equations 2.390
 - enter a new distortion characteristic 2.389
 - loading new distortion characteristics 2.387
 - selection 2.385
 - Distortion simulation
 - test procedure 5.70
 - Distortion simulator 2.383
 - level correction 2.388
 - Domain conflict** **2.212**
 - Doppler shift
 - Fading simulation 2.76, 2.80, 2.84, 3.87, 3.89, 3.92
 - Downlink
 - DECT 2.318
 - GSM/EDGE 2.301
 - NADC 2.262
 - PDC 2.279
 - PHS 2.115
 - Downlink signal
 - 3 GPPW-CDMA 2.182, 3.165
 - DPCCCH POWER 2.256
 - DPDCH POWER 2.255
 - DUMMY Burst (GSM/EDGE) 2.314
 - Duration blank signal 2.429, 3.197
 - Dwell list
 - LIST 2.404
 - MSEQ 2.406, 3.204
 - Dwell time
 - level sweep 2.398, 3.150
 - LF sweep 2.400, 3.197
 - LIST 2.404, 3.110
 - MSEQ 2.409, 3.204
 - RF sweep 2.397, 3.149
- E**
- ECL output 2.114
 - Edge (external trigger) 2.114, 2.429, 3.77, 3.214
 - Edit list 2.35
 - EMF 2.53
 - Enable register 3.219
 - Encryption scrambling (PHS) 2.127, 3.140
 - Enhanced channels
 - bit error 3.185, 3.190
 - bit errors 2.244
 - channel coding 2.243
 - channel start power 2.251
 - channelization code 2.251
 - data source 2.251, 2.252, 3.186, 3.192
 - external power control mechanism 2.254
 - multicode 2.252
 - symbol rate 2.256
 - Enhanced Channels 2.236, 3.180
 - Additional MS 2.260
 - Base station 3.183
 - bit error 3.184
 - Branching with 3GPP W-CDMA 2.237
 - channel coding 3.183
 - channel start power 3.185
 - channelization code 3.185
 - crest factor 2.257, 3.188
 - data field 3.187
 - data source 3.186
 - External power control 2.256
 - external power control mechanism 2.246, 3.183, 3.189
 - Maximum input level 2.259
 - mobile station 3.188
 - Multicode 3.187
 - OCNS channels 3.187
 - Overall symbol rate in uplink 2.255
 - overall symbol rate uplink 3.190
 - sequence length 3.184
 - Sequence length 2.248
 - symbol rate 2.248, 3.184
 - test procedure 5.62
 - timing offset 2.249, 3.184
 - Enhanced P-CCHCP/BCH State 2.241
 - Envelope control
 - DECT 2.327, 3.56
 - digital modulation 2.99, 2.112, 3.76
 - GSM/EDGE 2.309, 3.99
 - NADC 2.270, 3.118
 - PDC 2.287, 3.128
 - PHS 2.124, 3.137
 - Envelopes (3GPP W-CDMA)** **2.224**
 - EOI (command line) 3.8
 - EPROM, test 4.2
 - Equalizer (CDMA) 2.138
 - Error messages 2.433, 3.206, B.1
 - Error queue 3.200, 3.203, 3.226
 - Error rate measurement BLER
 - operating mode 3.34
 - Error vector
 - noise generation and distortion simulation 5.75
 - PSK 5.40
 - QAM 5.40
 - test procedure 5.27
 - Error vector magnitude
 - measure 5.27
 - ESE (event status enable register) 3.222
 - Event status enable register (ESE) 3.222
 - Exponent 3.9
 - EXT TUNE input 2.21, 2.414
 - EXT1/2
 - coupling 2.59, 2.61, 2.63, 3.50, 3.78, 3.142
 - input 2.21
 - External detuning 2.414
 - External modulation sources** **2.55**
 - External power control
 - Enhanced Channels 2.256
 - External power control mechanism 2.246, 2.254, 3.183, 3.189
 - External reference 2.414, 3.148
 - External trigger
 - active edge 2.114, 2.429, 3.77, 3.214
 - LIST 2.402, 3.212
 - MSEQ 2.407, 3.214
 - sweep 2.394, 3.210
- F**
- Fading simulation 2.70, 3.82
 - Area constant 2.77, 3.88
 - BIRTH-DEATH 2.83
 - Configuration 2.72, 2.73, 3.84
 - Correlation 2.77, 3.88
 - Correlation between paths 2.72
 - Correlation coefficient 2.77, 3.88
 - Coupled parameters 2.74, 3.86
 - Delay range 2.84
 - Doppler shift 2.76, 2.80, 2.84, 3.87, 3.89, 3.92
 - Dwell period 2.84, 3.92
 - Fine Delay 2.78
 - Insertion loss 2.74, 2.84, 3.86, 3.91
 - Log Normal fading 2.77, 3.88
 - Moving Delay 2.81
 - Output power 2.71

- Profile.....2.75, 2.80, 2.84, 3.87, 3.89, 3.92
 - Pseudo Noise Generator.....2.73, 3.84
 - Rayleigh fading.....2.75, 2.80, 3.87, 3.89
 - Ricean fading.....2.75, 3.87
 - Signal delay.....2.76, 2.80, 2.82, 2.84, 3.88, 3.90, 3.92
 - Standard Fading.....2.73
 - test assembly.....5.6
 - test procedure.....5.64
 - Time grid.....2.84
 - Two-channel fading.....2.71
 - Variation period.....2.82, 3.91
 - Fading simulator
 - calibration.....3.37
 - installation.....1.8
 - slot.....1.5
 - test.....4.2
 - FBI (3GPP W-CDMA).....2.175, 2.204, 2.206
 - Filter
 - 3GPP W-CDMA.....2.182, 2.183, 2.339, 3.165, 3.166
 - CDMA.....2.138, 3.104
 - DECT.....2.323, 3.55
 - digital modulation.....2.107, 3.75
 - GSM/EDGE.....2.306, 3.97, 3.98
 - NADC.....2.267, 3.116
 - PDC.....2.284, 3.126
 - PHS.....2.120, 3.135
 - W-CDMA.....2.157, 3.154
 - Filtering.....2.177
 - Fitting options.....1.4
 - FM
 - coupling.....2.61, 3.78
 - deviation.....2.61, 3.78
 - deviation limits.....2.62
 - frequency.....2.61, 3.79
 - modulator.....1.6
 - slot.....1.5
 - preemphasis.....2.61, 2.62, 3.79
 - Format, data (IEC/IEEE bus).....3.44
 - Forward link signal (CDMA).....2.136, 3.103
 - Frame
 - DECT.....2.328, 3.57
 - GSM/EDGE.....2.310, 3.100
 - NADC.....2.272, 3.120
 - PDC.....2.288, 3.129
 - PHS.....2.125, 3.138
 - Frequency**
 - accuracy.....1.2**
 - AM.....2.59, 3.50
 - FM.....2.61, 3.79
 - indication.....2.22
 - suppression.....2.413, 3.43
 - LF generator.....2.391, 3.194
 - LF sweep.....2.399, 3.195
 - list (LIST).....2.401, 3.111
 - offset.....2.45, 3.81
 - PM.....2.63, 3.143
 - RF output signal.....3.80
 - RF sweep.....2.396, 3.81
 - test procedure.....5.8
 - Frequency marker
 - LF sweep.....2.400, 3.196
 - RF sweep.....2.397, 3.112
 - Frequency modulation (FM).....2.61, 3.78
 - test procedure.....5.34
 - Frequency range (3GPP W-CDMA).....2.225
 - Frequency sweep
 - LF.....2.399, 3.197
 - RF.....2.396, 3.149
 - FSK modulation (digital modulation).....2.89
 - Full rate (CDMA).....2.146, 3.108
 - Functional test.....4.1
- ## G
- GET (Group Execute Trigger).....3.216
 - GPS.....3.93
 - GSM/EDGE.....2.301, 3.96
 - test procedure.....5.46
 - Guard data field
 - DECT.....2.333
 - GSM/EDGE.....2.314
 - NADC.....2.274
 - PDC.....2.295, 2.297, 2.299
 - PHS.....2.129
- ## H
- Half rate (CDMA).....2.146, 3.108
 - Handshake (RS232).....2.411, 3.202, A.6
 - Header (commands).....3.6
 - Header field (display).....2.22**
 - HOP mode(LIST).....2.402, 3.213
 - HOP output.....2.15
 - HOP trigger signal (GSM/EDGE).....2.312, 3.101
 - Hopping.....2.316
 - Hopping signal (digital modulation).....2.93
- ## I
- I FADED output.....2.13
 - I/Q
 - constellation diagram.....2.87
 - filter.....2.68
 - modulation.....2.66, 2.356, 3.65
 - I/Q imbalance
 - test procedure.....5.29
 - I/Q modulator
 - calibration.....2.419, 3.39
 - Idle data field (PHS).....2.129
 - IEC/IEEE bus
 - address.....2.410, 3.202
 - interface.....2.19, A.1
 - language.....2.414
 - Imbalance.....2.67, 3.66
 - Impairment.....2.67, 2.69, 3.65
 - Indentations.....3.12**
 - Indication
 - attenuator circuits.....2.427
 - counter.....2.427
 - error messages.....2.433, 3.200
 - modules.....2.424, 3.41
 - operating hours.....3.42
 - operating-hours.....2.427
 - serial number.....2.427, 3.15
 - software version.....2.427, 3.42
 - suppress.....2.413
 - Inhibition of retrigger
 - 3GPP W-CDMA.....2.185, 3.167
 - ARB.....2.347, 3.20
 - CDMA.....2.141, 3.105
 - DECT.....2.325, 3.56
 - digital modulation.....2.110, 3.77
 - GSM/EDGE.....2.307, 3.98
 - NADC.....2.269, 3.117
 - PDC.....2.286, 3.127
 - PHS.....2.122, 3.136
 - W-CDMA.....2.159, 3.155
 - Inhibition trigger
 - 3GPP W-CDMA.....2.337
 - Initial status.....1.2
 - Input.....2.15

- BIT CLOCK 2.7, 2.95
 - buffer 3.215
 - correction 2.27
 - CW 2.15
 - data 2.13
 - DATA 2.7, 2.96
 - Data enable 2.375
 - DATA-Dx 2.97
 - EXT TUNE 2.21, 2.414
 - EXT1/2 2.21
 - LEV-ATT 2.15
 - POW RAMP 2.17, 2.99
 - PULS 2.21
 - REF 2.19
 - RES 2.375
 - resistance 2.19, 2.21
 - SER DATA 2.17, 2.98
 - SYMBCLK 2.13, 2.97
 - SYMBOL CLOCK 2.7, 2.95
 - TRIGGER 2.21, 2.394, 2.402, 2.407, 2.429, 3.214
 - TRIGIN 2.15
 - Inputs for modulations 2.55
 - Insert list entry 2.38
 - Installation
 - options 1.4
 - software options** **1.15**, 2.431
 - Instrument reset 1.3, 3.16, 3.205
 - Instrument settings
 - recall 2.43, 3.16
 - save 2.43, 3.16
 - Integrating BER measurement 2.375
 - Interface
 - BER 2.19
 - functions (IEC/IEEE-bus) A.2
 - functions (RS-232-C) A.5
 - IEC/IEEE-bus 2.19
 - messages (IEC/IEEE-bus) A.3
 - PAR DATA 2.97
 - RS232 2.19
 - SERDATA 2.98, A.7
 - Interleaver function (Enhanced Channels) 3.183
 - Intermodulation suppression 2.50
 - Interpolation rate (ARB) 2.343
 - Interrupt 3.221
 - Interrupt-free level setting 2.50
 - IQ AUX output 2.13
 - IQ Multiplex (W-CDMA) 2.165
 - IS-95 CDMA 2.130, 3.102
 - test procedure 5.51
 - IST flag 3.15
- J**
- Jitter simulation (DECT) 2.328
- K**
- Key
 - /. 2.3
 - [ASSIGN] 2.11, **2.25**
 - [BACKSPACE] 2.3
 - [ERROR] 2.9, 2.433
 - [FREQ] 2.3, 2.45
 - [G/n] 2.5
 - [HELP] 2.9, 2.432
 - [k/m] 2.5
 - [LEVEL] 2.3, 2.47
 - [LOCAL] 2.9, 3.3
 - [M/ μ] 2.5
 - [MENU 1/2] 2.11, **2.25**
 - [MOD ON/OFF] 2.9, 2.58, 2.428
 - [PRESET] 1.3, 2.9
 - [RCL] 2.3, 2.43
 - [RETURN] 2.5, 2.23
 - [RF ON/OFF] 2.9, **2.26**, 2.54
 - [SAVE] 2.3, 2.43
 - [SELECT] 2.5, 2.23
 - [STATUS] 2.9, 2.432
 - [X1/Enter] 2.5
 - Key words (commands) 3.6
 - Keyboard
 - disabling 3.203
 - test procedure 5.8
- L**
- Leakage 2.67, 3.66
 - LEARN (LIST mode) 2.404, 3.111
 - LEV ATT
 - calibration 2.422, 2.423, 3.37
 - input/output 2.15
 - Level
 - attenuation
 - DECT 2.328, 3.57
 - digital modulation 2.93, 2.112, 3.77
 - GSM/EDGE 2.310, 3.99
 - NADC 2.271, 3.119
 - PDC 2.288, 3.128
 - PHS 2.125, 3.138
 - calibration 3.38
 - control 2.50, 3.144
 - control of burst
 - DECT 2.327, 3.56
 - digital modulation 2.112, 3.76
 - GSM/EDGE 2.309, 3.99
 - NADC 2.270, 3.118
 - PDC 2.287, 3.128
 - PHS 2.124, 3.137
 - correction
 - list UCOR 2.52, 3.51
 - indication 2.22
 - resolution 2.48
 - suppression 2.413, 3.43
 - limit 2.48, 3.145
 - list 2.401, 3.111
 - marker 2.399, 3.113
 - offset 2.48, 3.145
 - presetting (calibration) 3.38
 - RF output 2.47, 3.145
 - sweep 2.398, 3.146, 3.150
 - test procedure 5.12
 - unit 2.26, 2.47, 3.215
 - Level correction
 - polynomial 2.386
 - Polynomial 3.64
 - Level reduction
 - GSM/EDGE 2.316
 - LF
 - frequency 2.391, 3.194
 - generator 2.57, 2.391, 3.194
 - output 2.21, 2.391, 3.48
 - sweep 2.399, 3.195
 - Link direction
 - 3 GPP W-CDMA 2.182, 3.165
 - List
 - commands C.1
 - control (digital modulation) 2.93, 2.103, 3.71
 - delete 2.34

- dwll (LIST) 2.404, 3.110
 - dwll (MSEQ) 2.406, 3.204
 - edit 2.35
 - fill 2.36
 - frequency (LIST) 2.401, 3.111
 - function LEARN 2.404, 3.111
 - generate 2.33
 - instrument states (MSEQ) 3.204
 - level (LIST) 2.401, 3.111
 - level correction (UCOR) 2.52, 3.51
 - manual processing of the list 2.402
 - open 2.33
 - operating modes (LIST) 2.401, 3.110, 3.213
 - operating modes (MSEQ) 2.407, 3.204, 3.214
 - select 2.33
 - store 2.35
- LIST
 - inputs/outputs 2.402
 - operating modes 3.111
- List entry
 - delete 2.39
 - insert 2.38
- Load
 - frame (DECT) 2.329, 3.58
 - frame (GSM/EDGE) 2.311, 3.100
 - frame (NADC) 2.272, 3.120
 - frame (PDC) 2.289, 3.129
 - frame (PHS) 2.125, 3.138
 - mapping (CDMA) 2.144, 3.107
- Log Normal fading 2.77, 3.88
- Long form (commands) 3.7
- Low-distortion mode
 - CDMA 3.104
 - digital modulation 3.76
 - NADC 2.267, 3.117
 - PDC 2.284, 3.126
 - PHS 3.136
 - W-CDMA 2.158, 3.155
- Lower-case (commands) 3.7

- M**
- Magnitude spectrum of a W-CDMA signal 2.225
- Maintenance 4.1
- Mapping (CDMA) 2.144, 3.106
- Mapping data list (digital modulation) 3.72
- Marker
 - level sweep 2.399, 3.113
 - LF sweep 2.400, 3.196
 - RF sweep 2.397, 3.112
- MARKER
 - output 2.21, 2.395, 2.403, 2.429, 3.113, 3.196
- Maximal deviation
 - FM 2.62
 - PM 2.64
- Maximum input level (Enhanced Channels) 2.259
- Maximum value (commands) 3.9
- Memory
 - delete 2.413, 3.205
 - depth (data generator) 2.92
 - extension 2.86
 - installation 1.7
 - sequence (MSEQ) 2.406, 3.203, 3.214
- Memory extension SMIQB12
 - test procedure 5.41
- Menu
 - ANALOG MOD - AM 2.59
 - ANALOG MOD - BB-AM 2.60
 - ANALOG MOD - FM 2.61
 - ANALOG MOD - PM 2.63
- BIRTH-DEATH 2.83
- call 2.25
- cursor 2.23
- DIGITAL MOD 2.101
- DIGITAL STD - DECT 2.322
- DIGITAL STD - GSM/EDGE 2.305
- DIGITAL STD - IS-95- MODE - FWD_LINK_18 2.136
- DIGITAL STD - IS-95- MODE - REV_LINK 2.146
- DIGITAL STD - IS-95- MODE - REV_LINK_CODED 2.148
- DIGITAL STD - NADC 2.266
- DIGITAL STD - PDC 2.283
- DIGITAL STD - PHS 2.119
- DIGITAL STD - WCDMA/3GPP - Downlink 2.338
- DIGITAL STD - WCDMA/3GPP - downlink menu 2.179
- ERROR 2.433
- fields 2.23
- FINE DELAY 2.78
- FREQUENCY 2.45
- HELP 2.432
- keys 2.5
- LEVEL - ALC 2.51, 2.53
- LEVEL - EMF 2.53
- LEVEL - LEVEL 2.47
- LEVEL - UCOR 2.52
- LF OUTPUT 2.391
- LIST 2.403
- MEM SEQ 2.408
- MODULATION - PULSE 2.65
- MOVING DELAY 2.81
- NOISE/DIST 2.384
- NOISE/DIST - POLYNOMIAL 2.385
- overview (3GPP W-CDMA) 2.178
- path 2.23
- quick selection 2.25
- STATUS 2.432
- store 2.25
- summary 2.44
- SWEEP - FREQ 2.396
- SWEEP - LEVEL 2.398
- SWEEP - LF GEN 2.399
- UTILITIES - AUX I/O 2.429
- UTILITIES - BEEPER 2.430
- UTILITIES - CALIB - ALC TABLE 2.421
- UTILITIES - CALIB - ALL 2.417
- UTILITIES - CALIB - LEV ATT 2.422
- UTILITIES - CALIB - LEV PRESET 2.420
- UTILITIES - CALIB - VCO SUM 2.418
- UTILITIES - CALIB - VECTOR MOD 2.419
- UTILITIES - DIAG - C/N MEAS 2.426
- UTILITIES - DIAG - CONFIG 2.424
- UTILITIES - DIAG - PARAM 2.427
- UTILITIES - DIAG - TPOINT 2.425
- UTILITIES - INSTALL 2.431
- UTILITIES - MOD KEY 2.428
- UTILITIES - PHASE 2.415
- UTILITIES - PROTECT 2.416
- UTILITIES - REF OSC 2.414
- UTILITIES - SYSTEM - GPIB 2.410
- UTILITIES - SYSTEM - LANGUAGE 2.414
- UTILITIES - SYSTEM - RS232 2.411
- UTILITIES - SYSTEM - SECURITY 2.413
- UTILITIES - SYSTEM - SERDATA 2.412
- UTILITIES - TEST 4.2
- VECTOR MOD 2.67
- Menü
 - DIGITAL STD - WCDMA/3GPP - Downlink 2.335
- Messages
 - IEC/IEEE-bus 3.5
 - RS232 3.5
- Minimum value (commands) 3.8
- Misuse (3GPP W-CDMA) 2.195, 2.206, 3.169
- Mobile station

- additional..... 3.192
 - CDMA..... 2.130
 - configuration (3GPP W-CDMA)..... 2.199
 - Enhanced..... 3.188
 - W-CDMA..... 2.150
 - Modulation
 - AM..... 2.59, 3.50
 - analog
 - test assembly..... 5.2
 - BB-AM..... 2.60, 3.50
 - data (digital modulation) 2.92, 2.96, 2.97, 2.102, 3.69
 - asynchronous transmission..... 2.98
 - DECT 2.318, 3.53
 - Delay 2.106
 - digital..... 2.86, 3.67
 - external signal 2.56
 - FM..... 2.61, 3.78
 - GSM/EDGE..... 2.301, 3.96
 - I/Q 2.66, 3.65
 - inputs 2.55
 - IS-95 CDMA 2.130, 3.102
 - methods (digital modulation)..... 2.87
 - NADC..... 2.262, 3.115
 - PDC 2.279, 3.124
 - PHS..... 2.115, 3.134
 - PM..... 2.63, 3.142
 - pulse 2.65, 3.147
 - simultaneous..... 2.57
 - sources..... 2.55
 - vector 2.66, 3.65
 - W-CDMA..... 2.150
 - Modulation coder
 - installation 1.13
 - Modulation data
 - GSM/EDGE..... 2.317
 - Modulation depth
 - AM..... 2.59, 3.50
 - ASK..... 5.39
 - DECT 3.55
 - PM..... 2.63, 3.142
 - Modulation generator
 - test procedure 5.25
 - Module indication..... 2.424, 3.41
 - MSEQ (Memory Sequence)..... 2.406, 3.203, 3.214
 - Multi Channel (3GPP W-CDMA)..... 2.208
 - Multichannel (3GPP W-CDMA)..... 3.170
 - Multicode..... 2.177
 - 3GPP W-CDMA 3.173
 - Channel simulation (3GPP W-CDMA) 2.209, 3.171
 - enhanced channels 2.252
 - Enhanced Channels 3.187
 - W-CDMA..... 2.161, 3.156
 - Multiplex
 - Link Direction (W-CDMA) 2.156
 - Multisignal measurements 2.50
- N**
- NADC..... 2.262, 3.115
 - test procedure 5.48
 - Name of sequence (MSEQ)..... 2.34, 3.205
 - NAN..... 3.9
 - New Line (command line) 3.8
 - NINF..... 3.9
 - Noise generation
 - test procedure 5.70
 - Noise generator and distortion simulator**..... 2.383
 - installation** 1.12
 - NORM, Normal Burst (GSM/EDGE) 2.312
 - NTRansition register** 3.219
- Numeric
 - input field 2.3
 - suffix 3.7
 - values 2.3, 3.9
 - Nyquist filter
 - 3GPP W-CDMA 2.182, 3.165
 - CDMA..... 2.138, 2.139, 3.104
 - DECT..... 2.323, 3.55
 - NADC..... 2.267, 3.116
 - PDC..... 2.284, 3.126
 - PHS 2.120, 3.135
 - W-CDMA..... 2.157, 3.154
- O**
- OCNS..... 3.180
 - base station 3.187
 - Measurement..... 2.260
 - OCNS channels 3.187
 - fraction of power 2.258
 - Offset
 - frequency..... 2.46, 3.81
 - level 2.48, 3.145
 - Operating hours 3.42
 - Operating modes
 - LIST 2.401, 3.81, 3.111, 3.146, 3.212
 - MSEQ 2.407, 3.203, 3.214
 - sweep 2.393, 3.81, 3.146, 3.149, 3.197, 3.210
 - Operating-hours 2.427
 - Option
 - fitting..... 1.4
 - SM-B1 - Reference oscillator OCXO..... 1.5, 2.414
 - SM-B5 - FM/PM modulator..... 1.6, 2.61, 2.63
 - SMIQB11 - Data Generator..... 1.7, 2.92
 - SMIQB12 - Memory Extension..... 2.92
 - SMIQB14 - Fading Simulator 1.8
 - SMIQB15 - Second Fading Simulator 1.10
 - SMIQB17 - Noise generator and distortion simulator** 1.12, 2.383
 - SMIQB19 - Rear panel connections for RF and LF.... 1.16
 - SMIQB20 - Modulation Coder 1.13, 2.86
 - SMIQB21 - Bit Error Rate Test..... 1.14, 2.368
 - SMIQB42 - Digital Standard IS-95 CDMA 2.130
 - SMIQB47 - LOW ACP Filter..... 2.68
 - SMIQB48 - Enhanced Channels 2.236
 - SMIQB60 - Arbitrary Waveform Generator..... 2.341
 - Orthogonality 2.226, 2.230
 - Output
 - BB-AM 2.7
 - BIT CLOCK..... 2.7
 - BITCLK..... 2.15
 - BLANK..... 2.21, 2.394, 2.402, 2.429
 - buffer 3.217
 - CW..... 2.15
 - data..... 2.13
 - DATA 2.7
 - ECL..... 2.114
 - HOP..... 2.15
 - I FADED..... 2.13
 - IQ AUX 2.13
 - LEV-ATT..... 2.15
 - level RF..... 2.47, 3.144
 - LF 2.21, 2.391, 3.48
 - MARKER 2.21, 2.395, 2.403, 2.429, 3.113, 3.196
 - POW RAMP..... 2.17, 2.99
 - Q..... 2.9
 - Q FADED..... 2.13
 - REF 2.19, 2.414
 - RF..... 2.9, 3.47, 3.80
 - SYMBCLK..... 2.13

- SYMBOL CLOCK.....2.7
 TRIGOUT.....2.15
 voltage.....2.391, 3.48
 X_AXIS.....2.21, 2.394
 Output impedance
 test assembly.....5.5
 OVEN COLD.....1.2
 Overall symbol rate
 enhanced channels in uplink.....2.255
 Enhanced Channels in uplink.....3.190
 Overlapping execution.....3.216
 OVERLOAD.....2.54
 Overload protection.....2.54, 3.47
 Overmodulation.....2.57
 Overview
 menus.....2.44
 modulation sources.....2.55
 slots.....1.5
 status register.....3.220
 syntax elements.....3.11
- P**
- Page indicators.....2.196
 PAR DATA interface.....2.97
 Para. Predef. (3GPP W-CDMA).....2.189
 Parallel modulation data.....2.97
 Parallel poll.....3.226
 Parallel poll enable register (PPE).....3.222
 Parameter (commands).....3.9
 Parity (RS232).....3.202, **A.5**
 Password.....2.416, 3.205
 Path (commands).....3.6
 Pattern setting
 getting started.....2.27
 list editor.....2.39
 P-CCPCH/BCH.....2.238
 PCPCH (3GPP W-CDMA).....2.204
 PDC.....2.279, 3.124
 test procedure.....5.49
 Performance test report.....5.82
 Period of output signal
 DECT.....2.325, 3.56
 GSM/EDGE.....2.308, 3.98
 NADC.....2.269, 3.118
 PDC.....2.286, 3.127
 PHS.....2.122, 3.137
 Personal station (PS)
 DECT.....2.318
 GSM/EDGE.....2.301
 NADC.....2.262
 PDC.....2.279
 PHS.....2.115
 Phase (RF output signal).....2.415, 3.133
 Phase error
 GMSK.....5.40
 Phase modulation.....2.63, 3.142
 test procedure.....5.37
 Phase noise
 test assembly.....5.5
 PHS.....2.115, 3.134
 test procedure.....5.50
 Physical quantities.....3.8
 PM
 coupling.....2.63, 3.142
 deviation.....2.63, 3.142
 deviation limits.....2.64
 frequency.....2.63, 3.143
 generator.....2.63, 3.142
 modulator.....1.6, 3.142
 slot.....1.5
 Polarity
 BLANK signal.....2.429, 3.47
 marker signal.....2.429, 3.113, 3.196
 pulse modulation.....2.65, 3.147
 signal
 3GPP W-CDMA.....2.186
 3GPP W-CDMA signal.....2.337
 GSM.....2.308
 Trigger
 ARB.....2.347, 3.20
 Polynomial
 coefficient AM-AM.....2.385
 Coefficient AM-AM.....3.63
 coefficient AM-PM.....2.385
 Coefficient AM-PM.....3.64
 entering the parameters.....2.385
 equations.....2.390
 level correction.....2.386
 Level correction.....3.64
 PRBS.....2.375
 POW RAMP input/output.....2.17, 2.99
 Power
 channel (CDMA).....2.145, 3.106, 3.107
 channel (W-CDMA).....2.163, 2.167, 3.156, 3.158
 gating (CDMA).....2.146, 3.108
 ramping (DECT).....2.327, 3.56
 ramping (digital modulation).....2.112, 3.76
 ramping (GSM/EDGE).....2.309, 3.99
 ramping (NADC).....2.270, 3.118
 ramping (PDC).....2.287, 3.128
 ramping (PHS).....2.124, 3.137
 ratio (fading simulation).....3.87
 supply.....1.1
 total (W-CDMA).....3.156
 Power control.....2.176
 Power offset (additional MS).....2.261
 PPE (Parallel poll enable register).....3.222
 PRACH (3GPP W-CDMA).....2.202
 PRBS
 Polynomial.....2.375
 PRBS data (digital modulation).....2.94, 3.69
 Preamble (DECT)
 normal.....2.331
 prolonged.....2.332
 Preamble (PHS).....2.128
 Preamble data field (PDC).....2.292, 2.297, 2.299
 Preamble Repetition.....2.202, 2.203
 Preemphasis (FM).....2.61, 2.62, 3.79
 Preset (instrument states).....1.3, 3.205
 Profile (fading simulation).....2.75, 2.80, 2.84, 3.87, 3.89, 3.92
 Programming Examples.....D.1
 Protection level.....3.205
 Protective circuit.....2.54, 3.47
 PS-ID-Code-Data field (PHS).....2.129
 PSK modulation.....2.87
PTRansition register.....**3.219**
 Pulling range.....2.414
 PULS input.....2.21
 Pulse modulation.....2.65, 3.147
 polarity.....2.65, 3.147
 test assembly.....5.4
 test procedure.....5.33
 Pure doppler profile (fading simulation).....3.87
 Putting into operation.....1.1
- Q**
- Q FADED output.....2.13
 Q output.....2.9

- QAM modulation.....2.87
- Quadrature error**
- vector modulation** **5.29**
- Quadrature offset..... 2.67, 3.66
- Queries** **3.5**
- responses..... 3.8
- Question 3.11
- Quick selection**
- menu 2.25
- parameter** **2.25**
- Quotation marks 3.11
- R**
- Rack 19" 1.16
- RAM, test..... 4.2
- Ramp data field
- NADC..... 2.274
- PDC 2.292
- PHS..... 2.128
- RAMP data field
- DECT 2.331
- Rated characteristics
- checking 5.1
- test procedures..... 5.8
- Rayleigh fading 2.75, 2.80, 3.87, 3.89
- RCL list (MSEQ) 2.406, 3.204
- RECALCULATE 2.386, 3.64
- Recall
- frame (DECT) 2.329, 3.58
- frame (GSM/EDGE)..... 2.311, 3.100
- frame (NADC)..... 2.272, 3.120
- frame (PDC) 2.289, 3.129
- frame (PHS) 2.125, 3.138
- instrument settings 2.43, 3.16
- mapping (CDMA)..... 2.144, 3.107
- REF input/output..... 2.19, 2.414, 3.148
- Reference
- external 2.414, 3.148
- internal 2.414, 3.148
- oscillator (calibration)..... 2.417, 3.38
- oscillator OCXO..... 1.5, 2.414, 3.148
- Reference frequency
- test procedure 5.12
- Remote control 3.1
- REMOTE state 3.2
- Remove paneling** **1.4**
- RES input 2.375
- Reset status reporting system 3.227
- Responses to queries 3.8
- Reverse link signal (CDMA)..... 2.146, 2.148, 3.103
- RF
- frequency 2.45, 3.80
- output 2.9, 3.47
- output level..... 2.47, 3.145
- sweep..... 2.396, 3.149
- RF OFF 2.54
- Ricean fading..... 2.75, 3.87
- Roll-off factor
- 3GPP W-CDMA..... 2.183, 3.165
- CDMA..... 2.139, 3.104
- digital modulation..... 2.107, 3.75
- NADC..... 2.267, 3.117
- PDC 2.284, 3.126
- PHS..... 2.120, 3.136
- W-CDMA 2.157, 3.154
- Rotary knob 2.7, 2.23
- RS232 interface..... 2.19, 2.411, 3.202, A.4
- S**
- Same data (3GPP W-CDMA) 2.226
- Sample setting 2.27
- Sample-and-hold mode 2.50
- Save
- frame (DECT)..... 2.329, 3.58
- frame (GSM/EDGE) 2.311, 3.100
- frame (NADC) 2.272, 3.120
- frame (PDC)..... 2.289, 3.129
- frame (PHS)..... 2.125, 3.138
- instrument settings 2.43, 3.16
- mapping (CDMA) 2.145, 3.107
- SCPI
- conformity information C.1
- introduction 3.5
- Scrambling
- PDC 2.291, 2.299, 3.130
- PHS 2.127, 3.139
- Scrambling code 2.232
- Scrambling code generator** **2.171**
- Scrambling Unit** **2.174**
- Scrollbar 2.23
- Select
- 1-out-of-n** **2.24**
- mark 2.23
- Self test 3.16, 3.207, 4.1
- Semicolon 3.11
- Sequence length (3GPP W-CDMA)..... 2.182, 3.165
- SER DATA input 2.412
- SERDATA-Interface A.7
- Serial modulation data (digital modulation) 2.96
- Serial number 2.427, **3.15**
- Serial poll 3.225
- Service request (SRQ) 3.16, **3.225**
- Service request enable register (SRE) 3.16, 3.221
- Setting commands** **3.5**
- Setting conflicts (digital modulation) 2.91
- Setting time
- Test assembly..... 5.6
- Setting value** **2.24**
- Settling bit** **3.223**
- SFN 2.242
- SFN restart..... 2.242
- SFN Restart Trigger 2.215
- Short form (commands)..... 3.7
- Sign 3.9
- Signal (data generator)
- BGATE (burst gate) 2.93
- CW (continuous wave)..... 2.93
- HOP (hopping)..... 2.93
- LATT (level attenuation)..... 2.93
- TRIG 1/2 (trigger output1/2) 2.93
- Signal delay
- Fading simulation.. 2.76, 2.80, 2.82, 2.84, 3.88, 3.90, 3.92
- Signal generation
- downlink (W-CDMA)..... 2.150
- downlink and uplink without IQ multiplex (W-CDMA) 2.154
- uplink with IQ multiplex (W-CDMA) 2.151, 2.165
- Signature (3GPP W-CDMA) 2.175, 2.202, 2.204
- Simulation of scenarios 2.234
- Simultaneous modulation 2.57
- Slot
- Configuration
- GSM/EDGE 2.316
- Slot (DECT)..... 2.330
- Slot and frame builder** **2.175**
- SMIQ03S
- Additional measurements..... 5.80
- Software option 2.431
- Software version 2.427, 3.42
- SOURce

- Modulation subsystem..... 3.114
 - Source resistance..... 2.54
 - Span (RF sweep)..... 2.396, 3.81
 - Special characters**..... **3.13**
 - Spectral purity..... 2.62, 2.64
 - test procedure..... 5.18
 - Spectrum of a W-CDMA signal..... 2.225
 - Spreading scheme..... 2.220
 - Spurious-Free Dynamic Range
 - test procedure..... 5.78
 - Square brackets..... 3.7
 - SRE (service request enable register)..... 3.16, 3.221
 - SRQ (service request)..... 3.16, **3.225**
 - Standard Fading..... 2.73
 - STANDBY mode..... 1.1, 1.2, 2.11
 - Start bit (RS232)**..... **A.5**
 - Start frequency
 - LF sweep..... 2.400, 3.195
 - RF sweep..... 2.396, 3.81
 - Start level (level sweep)..... 2.398, 3.146
 - State REMOTE..... 3.2
 - STATus
 - OPERation register..... 3.199, 3.223
 - QUESTionable register..... 3.200, **3.224**
 - Status byte (STB)..... 3.221
 - Status line**..... **2.22**
 - STATUS page..... 2.432
 - Status register (overview)..... 3.220
 - Status reporting system..... 3.218
 - STB (status byte)..... 3.221
 - Steal Flag data field (PDC)..... 2.293, 2.300
 - Step width
 - frequency..... 2.45, 3.81
 - level..... 2.48, 3.146
 - level sweep..... 2.398, 3.151
 - LF sweep..... 2.400, 3.198
 - RF sweep..... 2.397, 3.150
 - rotary knob
 - frequency variation..... 2.45, 3.81
 - level..... 3.146
 - level variation..... 2.48
 - Stop bit (RS232)..... 2.411, 3.202, **A.5**
 - Stop frequency
 - LF sweep..... 2.400, 3.195
 - RF sweep..... 2.396, 3.81
 - Stop level (level sweep)..... 3.146
 - Storage..... 4.1
 - Store
 - frame (DECT)..... 2.329, 3.58
 - frame (GSM/EDGE)..... 2.311, 3.100
 - frame (NADC)..... 2.272, 3.120
 - frame (PDC)..... 2.289, 3.129
 - frame (PHS)..... 2.125, 3.138
 - instrument settings..... 2.43, 3.16
 - list..... 2.35
 - mapping (CDMA)..... 2.145, 3.107
 - Structure
 - command..... 3.6
 - command line..... 3.8
 - Sum bit**..... **3.219**
 - Sum deviation..... 2.57
 - Sum modulation depth..... 2.57
 - two-tone modulation..... 2.57
 - Summation..... 2.177
 - Summing loop..... 2.418
 - slot..... 1.5
 - Sweep..... 2.392
 - level..... 2.398, 3.146, 3.151
 - level sweep..... 2.398
 - LF..... 2.399, 3.197
 - outputs..... 2.394
 - RF..... 2.396, 3.81, 3.149
 - test procedure..... 5.24
 - trigger..... 2.394, 3.210
 - Switchover to remote control..... 3.2
 - SYMBOL CLK input/output..... 2.13, 2.97
 - Symbol..... 2.25
 - Symbol clock
 - CDMA..... 2.142
 - digital modulation..... 2.111, 3.76
 - NADC..... 2.270, 3.118
 - PDC..... 2.287, 3.127
 - PHS..... 2.123, 3.137
 - SYMBOL CLOCK input/output..... 2.7, 2.95
 - Symbol rate
 - 3GPP W-CDMA..... 2.189, 2.197, 2.208, 3.170
 - DECT..... 2.323, 3.55
 - digital modulation..... 2.106, 3.75
 - enhanced channels..... 2.248, 2.256, 3.184
 - GSM/EDGE..... 2.305, 3.97
 - NADC..... 2.267, 3.116
 - OCNS..... 2.257, 3.188
 - PDC..... 2.284, 3.126
 - PHS..... 2.120, 3.135
 - SYNC burst (DECT)..... 2.330
 - SYNC burst (PHS)..... 2.127
 - Synchronization
 - CDMA..... 2.133
 - command..... 3.217
 - DECT..... 2.319
 - PHS..... 2.116
 - signal generation (digital modulation)..... 2.93
 - W-CDMA..... 2.152
 - Synchronization signal
 - 3GPP W-CDMA..... 2.215
 - Synthesis range..... 2.62, 2.64
 - System bandwidth..... 2.384
 - System components (3GPP W-CDMA)..... 2.171
 - System frame number..... 2.236, 2.238, 2.242
 - System Frame Number..... 2.241
 - System information BCH..... 2.242
- ## T
- Tags (ARB)..... 3.23
 - Tail data field (GSM/EDGE)..... 2.312, 2.316
 - TCH, Traffic Channel configuration
 - NADC..... 2.274, 3.121
 - PDC..... 2.291, 3.130
 - PHS..... 2.127, 3.139
 - Termination criteria
 - BLER..... 2.381
 - Test..... 2.427
 - Test assembly..... 5.2
 - analog modulations..... 5.2
 - broadband FM..... 5.3
 - fading simulation..... 5.6
 - output impedance..... 5.5
 - pulse modulation..... 5.4
 - Setting time..... 5.6
 - SSB phase noise..... 5.5
 - vector modulation..... 5.4
 - Test equipment..... 5.1
 - Test frequency (recommended)..... 5.7
 - Test level (recommended)..... 5.7
 - Test model (3GPP W-CDMA)..... 2.180
 - Test points..... 2.425, 3.42
 - Test procedure
 - 3GPP W-CDMA..... 5.53
 - amplitude modulation..... 5.31
 - Arbitrary Waveform Generator..... 5.77
 - Bit error rate test..... 5.63

- broadband AM 5.33
 - data generator 5.41
 - DC voltage offset 5.78
 - DECT 5.47
 - digital modulation 5.38
 - digital standards 5.45
 - Enhanced Channels 5.62
 - error vector 5.27
 - fading simulation 5.64
 - frequency 5.8
 - frequency modulation 5.34
 - GSM/EDGE 5.46
 - I/Q imbalance 5.29
 - IS-95 CDMA 5.51
 - level 5.12
 - Measurements for SMIQ03S 5.80
 - memory extension SMIQB12 5.41
 - modulation generator 5.25
 - NADC 5.48
 - noise generation and distortion simulation 5.70
 - PDC 5.49
 - phase modulation 5.37
 - PHS 5.50
 - pulse modulation 5.33
 - reference frequency 5.12
 - spectral purity 5.18
 - spurious-free dynamic range 5.78
 - sweep 5.24
 - TETRA 5.48
 - vector modulation 5.26
 - W-CDMA 5.52
 - Test procedures 5.8
 - TETRA - Digital standard
 - test procedure 5.48
 - TFCI (3GPP W-CDMA) 2.175, 2.194, 2.205, 3.169
 - Time domain (3GPP W-CDMA) 2.219
 - Time grid
 - Fading simulation 2.84
 - Timing offset (3GPP W-CDMA) 2.176, 2.198, 2.205, 2.209, 2.229, 3.173
 - Timing offset (Enhanced Channels) 2.249
 - Total power
 - 3GPP W-CDMA 2.187, 3.168
 - CDMA 2.143, 3.106
 - TPC (3GPP W-CDMA) 2.175, 2.198, 2.200, 3.173
 - TPC bit (3GPP W-CDMA) 2.195, 2.206, 3.169
 - Training sequence code (GSM/EDGE) 2.312, 2.317
 - Transfer clock 2.373
 - Trigger
 - 3GPP W-CDMA 2.184, 2.336, 3.167
 - active edge 2.114, 2.429, 3.77, 3.214
 - ARB 2.347, 3.20
 - CDMA 2.140, 3.105
 - DECT 2.319, 2.323, 3.55
 - delay
 - 3GPP W-CDMA 2.336
 - digital modulation 2.109, 3.69, 3.77
 - GPS 3.94
 - GSM/EDGE 2.306, 3.98
 - inhibition
 - 3GPP W-CDMA 2.337
 - ARB 2.347, 3.20
 - inhibition (3GPP W-CDMA) 2.185, 3.167
 - inhibition (CDMA) 2.141, 3.105
 - inhibition (DECT) 2.325, 3.56
 - inhibition (digital modulation) 2.110, 3.77
 - inhibition (GSM/EDGE) 2.307, 3.98
 - inhibition (NADC) 2.269, 3.117
 - inhibition (PDC) 2.286, 3.127
 - inhibition (PHS) 2.122, 3.136
 - inhibition (W-CDMA) 2.159
 - LIST 2.402, 3.212
 - MSEQ 3.214
 - NADC 2.267, 3.117
 - OFF TIME (ARB) 2.348, 3.21
 - ON TIME (ARB) 2.348, 3.21
 - oscilloscope 2.394, 3.112
 - PDC 2.284, 3.126
 - PHS 2.116, 2.120, 3.136
 - Sequence control (ARB) 2.345, 3.19
 - source
 - 3GPP W-CDMA 2.185, 2.336, 3.167
 - ARB 2.347, 3.20
 - sweep 2.394, 3.210
 - W-CDMA 2.158, 3.155
 - XY recorder 2.394, 3.149
 - TRIGGER
 - input 2.21, 2.402, 2.407, 2.429
 - Trigger generator (ARB) 2.344
 - Trigger Out GSM 2.308
 - Trigger signal
 - 3GPP W-CDMA 2.215
 - Triggering action** **2.25**
 - TRIGIN input 2.15
 - TRIGOUT output 2.15
 - Truth values 3.8
 - Tuning voltage 2.415
 - Two-channel fading 2.71
 - Two-tone modulation 2.57
- ## U
- UCOR (level correction) 2.52, 3.51
 - Uncorrelated data (3GPP W-CDMA) 2.226
 - Unique word (PHS) 2.128
 - Unit 2.5, 3.8, 3.215
 - Universal commands A.3
 - Uplink
 - DECT 2.318
 - GSM/EDGE 2.301
 - NADC 2.262
 - PDC 2.279
 - PHS 2.115
 - Uplink signal
 - 3 GPPW-CDMA 2.182, 3.165
 - User correction (UCOR) 2.52, 3.51
- ## V
- Variation period
 - Fading simulation 2.82, 3.91
 - VCO SUM calibration 2.418, 3.39
 - Vector modulation 2.66, 2.67, 2.356, 3.65
 - calibration 2.419, 3.39
 - IQ filter 2.68
 - Quadrature error** **5.29**
 - test assembly 5.4
 - test procedure 5.26
 - Ventilation ducts** **1.4**
 - Voltage
 - external modulation signal 2.56
 - LF output 2.391, 3.48
 - VOX
 - PDC 2.298, 3.130
 - PHS 2.127, 3.139

W

Walsh code (CDMA).....	2.145, 3.107
Waveform memory (3GPP W-CDMA).....	2.183
W-CDMA	2.150
Multicode.....	3.156
test procedure	5.52
Trigger.....	2.158
W-CDMA 3GPP.....	2.169, 3.159
Additional	3.180
Enhanced Channels	3.180
OCNS.....	3.180
test procedure	5.53
White space.....	3.11
WinIQSIM	
Support of ARB	2.344

X

X field (DECT).....	2.333
X_AXIS output	2.21, 2.394
XY recorder.....	2.394, 3.149

Z

Z field (DECT).....	2.333, 3.60
---------------------	-------------